

VOLVO EXCAVATORS

EC140D, EC160D, EC220D

12.9-24.6 t / 28,370-54,190 lb 114-173 hp



A PASSION FOR PERFORMANCE.

At Volvo Construction Equipment, we're not just coming along for the ride. Developing products and services that raise productivity – we are confident we can lower costs and increase profits for industry experts. Part of the Volvo Group, we are passionate about innovative solutions to help you work smarter – not harder.

Helping you to do more

Doing more with less is a trademark of Volvo Construction Equipment. High productivity has long been married to low energy consumption, ease of use and durability. When it comes to lowering life-cycle costs, Volvo is in a class of its own.

Designed to fit your needs

There is a lot riding on creating solutions that are suited to the particular needs of different industry applications. Innovation often involves high technology – but it doesn't always have to. Some of our best ideas have been simple, based on a clear and deep understanding of our customers' working lives.



You learn a lot in 175 years

Over the years, Volvo has advanced solutions that have revolutionized the use of construction equipment. No other name speaks Safety louder than Volvo. Protecting operators, those around them and minimizing our environmental impact are traditional values that continue to shape our product design philosophy.

We're on your side

We back the Volvo brand with the best people. Volvo is truly a global enterprise, one that is on standby to support customers quickly and efficiently – wherever they are.

We have a passion for performance.

A strong, dedicated, capable dealer network.

Our dealers are strategically located throughout North America to provide the equipment you need and the parts and service support you demand for a productive and profitable operation.

The strength of our dealer network is enhanced with extensive individualized product and product support training at our state-of-the-art Technical Training Center in Asheville and through hands-on training. At our nearby 80-acre Product Demonstration Center, visitors operate equipment from our entire product line under a variety of simulated working conditions. Both facilities are in year-round use by our dealers and customers – more than 2,000 visit each year. **Building the best starts right here.**

The products designed and manufactured by Volvo Construction Equipment have their beginnings at the most advanced Research & Design centers in the industry. Volvo CE machines are designed in 11 R&D centers and produced in 15 manufacturing facilities across the world.

The major R&D center and manufacturing plant in the Americas is located in Shippensburg, Pennsylvania. This facility has been in operation for over 30 years and – with its recently added 200,000 sq ft expansion – now covers 570,000 sq ft on an 80 acre campus. Dedicated work teams and highly advanced technologies and techniques using the Volvo Production System ensure continuous quality improvements, labor savings and cost control to reach the high quality that our customers have come to expect from Volvo.

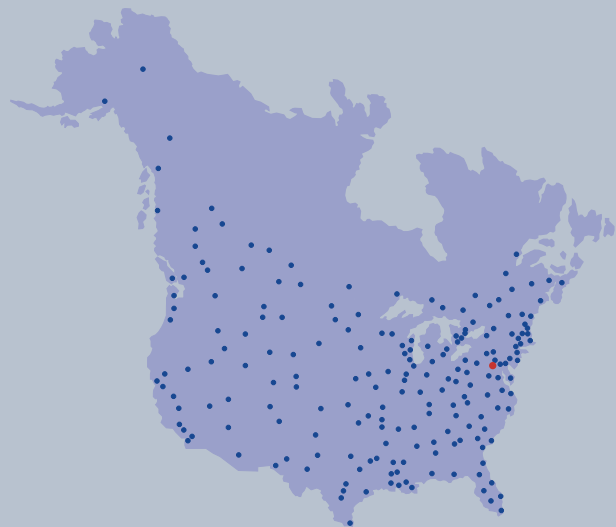



Mack Trucks



Volvo Construction Equipment



Volvo Penta



Volvo Trucks



Renault Trucks



UD Trucks



Volvo Buses



Volvo Aero



Volvo Financial Services

DESIGNED FOR EFFICIENCY.

Introducing Volvo's powerful, fuel efficient and environmentally responsible D-Series crawler excavators. Featuring Volvo's unique, award-winning ECO mode, the Tier 4 Interim engine and improved hydraulics, these machines deliver reduced fuel consumption and cycle times resulting in fuel efficiency improvements as well as increased digging performance.

Volvo Tier 4 Interim engine

Volvo's new fuel efficient engine features an active-type Diesel Particulate Filter (DPF) and a regeneration process to lower emissions. The unique method does not interrupt operation, performance or productivity.

ECO mode

Volvo's unique, award-winning ECO mode features sophisticated electronic pump control technology which contributes to up to 5% of the machine's total improved fuel efficiency without any loss of performance in most operating conditions.

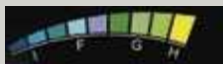
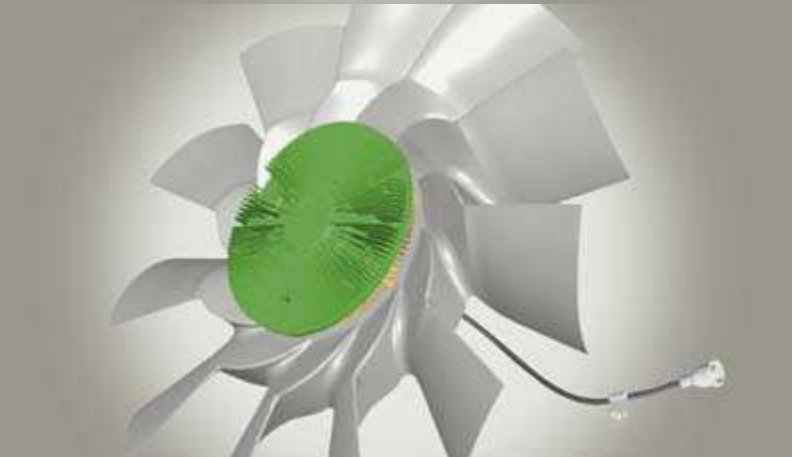

Work modes

Operators can select the best work mode for the task at hand to ensure optimum performance and fuel efficiency. Choose the correct mode according to your working conditions for added versatility and increased performance.

Proportional controlled viscous-clutch

Optimized fan speed control from the new proportional controlled viscous-clutch for reduced fuel consumption.

CONTROL IT. FASTER.

Volvo gives you more. More power, more capacity and more weight – command the new D-Series crawler excavators to handle your workload and enjoy increased total performance from our improved hydraulic system. Trust Volvo to put you in control.



Controllability

Smart hydraulic system enables smooth and highly responsive combined operation and travel. The system automatically prioritizes oil flow to the boom, arm or slew function according to requirements, resulting in faster cycle times.

Digging power and speed

Enhanced digging performance and faster cycle times, particularly when working with hard materials, from increased engine power and improved hydraulics.

Lifting capacity

Excellent lifting capacity and stability allows the machine to lift heavier objects ensuring greater productivity.



Grading

Superb grading performance from improved hydraulic system. Effortlessly smooth surfaces with harmonized flow control and well-matched attachment speed.

Attachment Management System

Allows storage of up to 18 different attachment presets and permits hydraulic flow (standard) and pressure (optional) to be adjusted to enable the use of various attachments for increased versatility. Operators can change attachments quickly without manual setup.

CONTROL IN COMFORT.



Volvo Care Cab

All-round visibility and a premium operator environment are at the heart of Volvo's cab design. The spacious cab, with ample storage and leg room, features an adjustable seat for excellent operator comfort, reduced whole body vibration and increased productivity.

Step inside Volvo's care cab and enjoy excellent all-round visibility. In this safe and comfortable environment operators will feel efficient and in control all day long. See more and do more with Volvo.

Rubber/Silicone oil viscous mounts

Spring is added to the mounts to improve shock absorption and reduce vibration. Increased operator comfort means more productivity.

I-ECU monitor

Large color monitor provides excellent clarity in all light conditions. Using a control panel the operator and service technician can make quick visual and diagnostic checks, increasing uptime and productivity. The monitor also displays camera images – up to four at a time.

ROPS

The cab features Roll Over Protective Structure (ROPS) which meets the ISO 12117-2 safety standard for increased peace of mind in the unlikely event of machine roll over.



Smart consoles and switches

High quality consoles and conveniently located switches for easy access and improved operator efficiency.

Automatic climate control system

Operators can set their ideal temperature with Volvo's powerful climate control system. Industry leading air circulation and defrosting capability is delivered with 14 well-spaced vents for increased comfort and productivity.

Rear view camera

Rear view camera provides visibility via the color I-ECU monitor for increased safety. The camera sits on top of the counterweight to project the area behind the machine.

SERVICEABILITY. SIMPLIFIED.

With built in serviceability the new Volvo D-Series crawler excavators guarantee you more uptime. Easy access to grouped service points allows for fast and effortless maintenance and service checks. Achieve more with Volvo.



Serviceability

Grouped filters and accessible radiators are quick to access from ground level via large, wide compartment doors – increasing safety. Easy access for maintenance means regular checks get done faster, giving you more uptime.

Grouped filters

Grouped, ground level filters in the pump compartment are accessible via one door for faster servicing and more machine uptime. This reduces the need for conducting maintenance at height, increasing safety.



Rear access (EC140D, EC160D)

Rear entry behind the cab grants safe and convenient access to the main hydraulic components and engine. Newly designed stairway allows for access to the top of the superstructure.



Service intervals on I-ECU

A service mode is incorporated into the I-ECU color monitor to enable diagnostic checks. Four separate service intervals – the engine oil/filter, fuel filter/water separator, hydraulic oil and hydraulic oil filter – are displayed on the monitor.



Stays and locking devices

Volvo's automatic stays prevent doors being blown closed for added safety, they can easily be manually released. Automatic locks ensure the doors close properly and enhance appearance.



Anti-slip plates

Added operator and service mechanic safety from punched anti-slip plate which provides superb grip, especially in wet or icy conditions.

TAKE A LOOK AROUND.



Fuel efficiency

The Volvo Tier 4 Interim engine together with improved hydraulics deliver fuel efficiency and shorter cycle times for increased performance.

ECO mode

Volvo's unique, award-winning ECO mode gives more fuel efficiency without any loss of performance.

Work modes

Achieve optimum performance and increased fuel efficiency by selecting the best work mode for the task at hand.

Digging power and speed

Perform at a higher level with increased digging power and faster cycle times for greater productivity.



Controllability

Smart hydraulic system for smooth and highly responsive combined operation and travel by prioritizing oil flow according to requirements.



Dozer blade (140D/160D)

Increase versatility and stability with a dozer blade.



CareTrack

Volvo's telematics system guides machine owners towards optimized productivity and their next service – remotely.



Volvo Care Cab

Enjoy all-round visibility, easy to access controls and excellent air ventilation in Volvo's spacious cab which meets ROPS safety standards.

Anti-slip plates

Added operator and service mechanic safety from punched anti-slip plate which provides superb grip, especially in wet or icy conditions.

Grouped filters

Grouped, ground level filters in the pump compartment enable faster servicing and more machine uptime.

Rear access (140D/160D)

Rear entry behind the cab grants safe and convenient access to the main hydraulic components and engine.

Powerful engine

Volvo's efficient Tier 4 Interim engine gives you more power while consuming less fuel for low emission levels.



Serviceability

Premium serviceability from large, wide opening doors featuring automatic stays and locking devices.

STRENGTH TO SUPPORT YOU AND YOUR BUSINESS.

The day you receive your new Volvo Excavator is just the start of your working relationship with Volvo. From service and maintenance to our CareTrack telematics system – Volvo has a comprehensive and sophisticated aftermarket portfolio to continuously add value to your business.

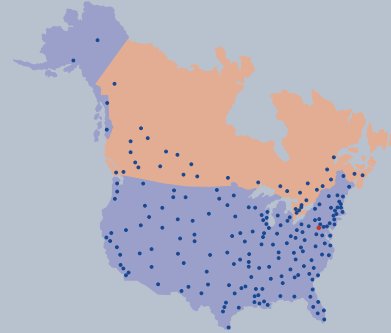

CareTrack - Volvo's telematics system works with our exclusive machine tracking info system, MATRIS, using guided diagnostics to track and analyze machines remotely - minimizing costs and maximizing uptime.



Customer Support Agreements - Gives you peace of mind by reducing total ownership costs, maximizing uptime, and distributing maintenance and major repair costs.



Attachments - Providing customers with a wide variety of attachments keep your machine working and open up new job opportunities.



Volvo designed and built your machines, so no-one knows how to keep them working in top condition more than us. When it comes to your machine, our Volvo trained technicians are the experts.

Our technicians work with industry leading diagnostic tools and techniques, using only Genuine Volvo Parts to deliver the highest levels of quality and service. Talk to your Volvo dealer about how genuine Volvo services can best provide the service and maintenance plan that is the right fit for you and your business.

State-of-the-art machines require state-of-the-art support and your Volvo dealer can provide a catalogue of services designed to get the most out of your machine, helping you maximise uptime, productivity and residual value. Your Volvo dealer can provide a number of sophisticated support offers, including:

Service plans ranging from routine wear inspections, through to comprehensive maintenance and repair agreements.

Analysis and diagnostics to help you understand how your machine is running, highlight potential maintenance issues and identify where performance can be improved.

Eco Operator training courses can help your operators work towards a safer, more productive and fuel efficient performance.

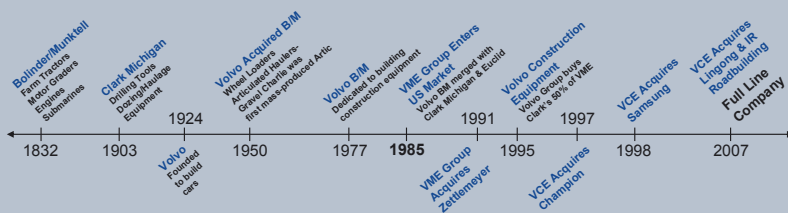

VOLVO EC140D, EC160D, EC220D IN DETAIL.

Engine

The latest generation, Volvo engine Tier 4i (Stage IIIB) emissions compliant diesel engine fully meets the demands of the latest, emissions regulations. The engine uses precise, high-pressure fuel injectors, turbo charger and air-to-air intercooler, and electronic engine controls to optimize machine performance.

Air Filter: 3-stage with pre-cleaner.

Automatic Idling System: Reduces engine speed to idle when the levers and pedals are not activated resulting in less fuel consumption and low cab noise levels.

| EC140D | | |
|----------------------------|-------------|--------------|
| Engine | Volvo | D4H |
| Max power at | r/s / r/min | 33,3 / 2,000 |
| Net, ISO 9249/SAE J1349 | kW / hp | 84 / 113 |
| Gross, ISO 14396/SAE J1995 | kW / hp | 85 / 114 |
| Max torque at | Nm / r/min | 535 / 1,500 |
| | lb. ft | 395 |
| No. of cylinders | | 4 |
| Displacement | l / cu. in | 4,036 / 246 |
| Bore | mm / in | 101 / 3.98 |
| Stroke | mm / in | 126 / 4.96 |

| EC160D | | |
|----------------------------|-------------|--------------|
| Engine | Volvo | D4H |
| Max power at | r/s / r/min | 33,3 / 2,000 |
| Net, ISO 9249/SAE J1349 | kW / hp | 104 / 139 |
| Gross, ISO 14396/SAE J1995 | kW / hp | 105 / 141 |
| Max torque at | Nm / r/min | 609 / 1,600 |
| | lb. ft | 449 |
| No. of cylinders | | 4 |
| Displacement | l / cu. in | 4,036 / 246 |
| Bore | mm / in | 101 / 3.98 |
| Stroke | mm / in | 126 / 4.96 |

| EC220D | | |
|----------------------------|-------------|-------------|
| Engine | Volvo | D6H |
| Max power at | r/s / r/min | 30 / 1,800 |
| Net, ISO 9249/SAE J1349 | kW / hp | 128 / 172 |
| Gross, ISO 14396/SAE J1995 | kW / hp | 129 / 173 |
| Max torque at | Nm / r/min | 849 / 1,350 |
| | lb. ft | 626 |
| No. of cylinders | | 6 |
| Displacement | l / cu. in | 5,7 / 348 |
| Bore | mm / in | 98 / 3.86 |
| Stroke | mm / in | 126 / 4.96 |

Electrical system

High-capacity electrical system that is well protected.

Waterproof double-lock harness plugs are used to secure corrosion-free connections. The main relays and solenoid valves are shielded to prevent damage. The master switch is standard. Contronics provides advanced monitoring of machine functions and important diagnostic information on the I-ECU.

| | EC140D | EC160D | EC220D |
|------------------|--------|----------|----------|
| Voltage | V | 28 | 24 |
| Batteries | V | 2 x 12 | 2 x 12 |
| Battery capacity | Ah | 100 | 140 |
| Alternator | V / Ah | 28 / 110 | 28 / 110 |

Swing system

The swing system uses an axial piston motors, driving a planetary gearbox for maximum torque. An automatic holding brake and anti-rebound valve are standard.

| | r/min | 12.5 | 12.5 | 12.1 |
|------------------|--------|--------|--------|--------|
| Max. slew speed | r/min | 12.5 | 12.5 | 12.1 |
| Max. slew torque | kNm | 38,8 | 51,7 | 76,7 |
| | lb. ft | 28,620 | 38,130 | 56,570 |

Drive

Each track is powered by an automatic two-speed shift travel motor. The track brakes are multi-disc, spring-applied and hydraulic released. The travel motor, brake and planetary gears are well protected within the track frame.

| | | | | |
|-------------------|------|-----------|-----------|-----------|
| Max. drawbar pull | kN | 118 | 145 | 183 |
| | lb | 26,530 | 32,600 | 41,150 |
| Max. travel speed | km/h | 3,1 / 5,5 | 3,1 / 5,6 | 3,3 / 5,5 |
| | mph | 1.9 / 3.4 | 1.9 / 3.5 | 2.1 / 3.4 |
| Gradeability | ° | 35 | 35 | 35 |

Undercarriage

The undercarriage has a robust X-shaped frame. Greased and sealed track chains are standard.

| | | | | |
|---------------------------------|----|-----------------------------------|--------|--------|
| Track pads | | 2 x 46 | 2 x 44 | 2 x 49 |
| Link pitch | mm | 171 | 190 | 190 |
| | in | 6.8 | 7.5 | 7.5 |
| Shoe width, triple grouser | mm | 500 / 600 / 700 / 750 / 800 / 900 | | |
| | in | 20 / 24 / 28 / 30 / 32 / 36 | | |
| Shoe width, triple grouser (HD) | mm | 600 / 700 | - | 600 |
| | in | 24 / 28 | - | 24 |
| Shoe width, double grouser | mm | - | - | 700 |
| | in | - | - | 28 |
| Shoe width, rubber shoe | mm | 500 | - | - |
| | in | 20 | - | - |
| Bottom rollers | | 2 x 7 | 2 x 7 | 2 x 8 |
| Top rollers | | 2 x 1 | 2 x 2 | 2 x 2 |

VOLVO EC140D, EC160D, EC220D IN DETAIL.

Hydraulic system

The hydraulic system, also known as the "Automatic Sensing Work Mode" is designed for high-productivity, high-digging capacity, high-maneuvering precision and excellent fuel economy. The summation system, boom, arm, bucket and swing priority along with boom and arm regeneration provides optimum performance. The following important functions are included in the system:

Summation system: Combines the flow of both hydraulic pumps to ensure quick cycle times and high productivity.

Boom priority: Gives priority to the boom operation for faster raising when loading or performing deep excavations.

Arm priority: Gives priority to the arm operation for faster cycle times in leveling and for increased bucket filling when digging.

Swing priority: Gives priority to swing functions for faster simultaneous operations.

Hydraulic Regeneration system: Prevents cavitation and provides flow to other movements during simultaneous operations for maximum productivity.

Power boost: All digging and lifting forces are increased.

Holding valves: Boom and arm holding valves prevent the digging equipment from creeping.

| | | EC140D | EC160D | EC220D |
|---|-------|---------|---------|---------|
| Main pump, Type 2 x variable displacement axial piston pumps | | | | |
| Maximum flow | l/min | 2 x 124 | 2 x 152 | 2 x 207 |
| | gpm | 2 x 33 | 2 x 40 | 2 x 55 |
| Pilot pump, Type Gear pump | | | | |
| Maximum flow | l/min | 1 x 20 | 1 x 20 | 1 x 18 |
| | gpm | 1 x 5 | 1 x 5 | 1 x 5 |

Hydraulic motors

| | | EC140D | EC160D | EC220D |
|---|-----|---------------|---------------|---------------|
| Travel: Variable displacement axial piston motor with mechanical brake | | | | |
| Slew: Fixed displacement axial piston motor with mechanical brake | | | | |
| Relief valve setting | | | | |
| Implement | MPa | 32,4 / 34,3 | 34,3 / 36,3 | 34,3 / 36,2 |
| | psi | 4,690 / 4,980 | 4,980 / 5,260 | 4,980 / 5,260 |
| Travel circuit | MPa | 34,3 | 34,3 | 34,3 |
| | psi | 4,980 | 4,980 | 4,980 |
| Slew circuit | MPa | 24,5 | 26,5 | 27,9 |
| | psi | 3,560 | 3,840 | 4,050 |
| Pilot circuit | MPa | 3,9 | 3,9 | 3,9 |
| | psi | 570 | 570 | 570 |

Hydraulic cylinders

| | | EC140D | EC160D | EC220D |
|---------------------------|--------|-------------|-------------|-------------|
| Mono boom | | 2 | 2 | 2 |
| Bore x Stroke | ø x mm | 105 x 980 | 115 x 1 165 | 125 x 1 235 |
| | ø x in | 4.1 x 38.6 | 4.5 x 45.9 | 4.9 x 48.6 |
| 2 piece boom | | 1 | - | 1 |
| Bore x Stroke | ø x mm | 160 x 765 | - | 160 x 1 070 |
| | ø x in | 6.3 x 30.1 | - | 6.3 x 42.1 |
| Arm | | 1 | - | 1 |
| Bore x Stroke | ø x mm | 120 x 1 345 | - | 135 x 1 540 |
| | ø x in | 4.7 x 53.0 | - | 5.3 x 60.6 |
| Bucket | | 1 | 1 | 1 |
| Bore x Stroke | ø x mm | 100 x 865 | 105 x 1 000 | 120 x 1 065 |
| | ø x in | 3.9 x 34.1 | 4.1 x 39.4 | 4.7 x 41.9 |
| Bucket for LR boom | | - | - | 1 |
| Bore x Stroke | ø x mm | - | - | 100 x 865 |
| | ø x in | - | - | 3.9 x 34.1 |

Service refill capacities

| | | EC140D | EC160D | EC220D |
|--------------------------------|-----|---------|---------|---------|
| Fuel tank | l | 258 | 258 | 335 |
| | gal | 68 | 68 | 89 |
| Hydraulic system, total | l | 250 | 255 | 300 |
| | gal | 66 | 67 | 79 |
| Hydraulic tank | l | 91 | 111 | 150 |
| | gal | 24 | 29 | 40 |
| Engine oil | l | 16 | 16 | 32 |
| | gal | 4 | 4 | 8 |
| Engine coolant | l | 28 | 30 | 41 |
| | gal | 7 | 8 | 11 |
| Slew reduction unit | l | 3.9 | 2.6 | 6 |
| | gal | 1 | 0.7 | 2 |
| Travel reduction unit | l | 2 x 2,2 | 2 x 5,8 | 2 x 5,8 |
| | gal | 2 x 1 | 2 x 2.0 | 2 x 2 |

Cab

The operator's cab has easy access via a wide door opening. The cab is supported on hydraulic dampening mounts to reduce shock and vibration levels. These along with sound absorbing lining provide low noise levels. The cab has excellent all-round visibility. The front windshield can easily slide up into the ceiling, and the lower front glass can be removed and stored in the side door. Integrated air-conditioning and heating system: The pressurized and filtered cab air is supplied by an automatically-controlled fan. The air is distributed throughout the cab from 14 vents. Ergonomic operator's seat: The adjustable seat and joystick console move independently to accommodate the operator. The seat has nine different adjustments plus a seat belt for the operator's comfort and safety.

Sound level

| | | EC140D | EC160D | EC220D |
|---|-------|-----------|-----------|-----------|
| Sound level in cab according to ISO 6396 | | | | |
| LwA - Std. / High Capacity Cooling | dB(A) | 69 / 70 | 69 / 70 | 69 / 70 |
| External sound level according to ISO 6395 and EU Noise Directive (2000/14/EC) and 474-1:2006 +A1:2009 | | | | |
| LwA - Std. / High Capacity Cooling | dB(A) | 100 / 101 | 101 / 102 | 102 / 103 |

SPECIFICATIONS.

MAXIMUM PERMITTED BUCKETS

EC140DL with 2 100 kg (4,630 lb) counterweight with Direct Fit Boom, Direct Fit

| Arm | 2,1 m (6' 11") | | 4,6 m (15' 1") Mono-Boom | | 3,0 m (9' 10") | |
|--|----------------|-----------------|--------------------------|-----------------|----------------|-----------------|
| | liter | yd ³ | liter | yd ³ | liter | yd ³ |
| GP bucket 1,5 t/m ³ (2,530 lb/yd ³) | 875 | 1.14 | 800 | 1.05 | 700 | 0.92 |
| GP bucket 1,8 t/m ³ (3,030 lb/yd ³) | 775 | 1.01 | 700 | 0.92 | 600 | 0.78 |
| HD bucket 1,8 t/m ³ (3,030 lb/yd ³) | 750 | 0.98 | 675 | 0.88 | 575 | 0.75 |
| HD bucket 2,0 t/m ³ (3,370 lb/yd ³) | 700 | 0.92 | 625 | 0.82 | 550 | 0.72 |

EC140DL with 2 100 kg (4,630 lb) counterweight with Quick Coupler Boom, Quick Coupler

| Arm | 2,1 m (6' 11") | | 4,6 m (15' 1") Mono-Boom | | 3,0 m (9' 10") | |
|--|----------------|-----------------|--------------------------|-----------------|----------------|-----------------|
| | liter | yd ³ | liter | yd ³ | liter | yd ³ |
| GP bucket 1,5 t/m ³ (2,530 lb/yd ³) | 800 | 1.05 | 725 | 0.95 | 600 | 0.78 |
| GP bucket 1,8 t/m ³ (3,030 lb/yd ³) | 700 | 0.92 | 625 | 0.82 | 550 | 0.72 |
| HD bucket 1,8 t/m ³ (3,030 lb/yd ³) | 675 | 0.88 | 600 | 0.78 | 500 | 0.65 |
| HD bucket 2,0 t/m ³ (3,370 lb/yd ³) | 625 | 0.82 | 550 | 0.72 | 475 | 0.62 |

EC140DL with 2 450 kg (5,400 lb) counterweight with Direct Fit Boom, Direct Fit

| Arm | 2,1 m (6' 11") | | 4,6 m (15' 1") Mono-Boom | | 3,0 m (9' 10") | |
|--|----------------|-----------------|--------------------------|-----------------|----------------|-----------------|
| | liter | yd ³ | liter | yd ³ | liter | yd ³ |
| GP bucket 1,5 t/m ³ (2,530 lb/yd ³) | 950 | 1.24 | 800 | 1.05 | 700 | 0.92 |
| GP bucket 1,8 t/m ³ (3,030 lb/yd ³) | 825 | 1.08 | 700 | 0.92 | 600 | 0.78 |
| HD bucket 1,8 t/m ³ (3,030 lb/yd ³) | 800 | 1.05 | 675 | 0.88 | 575 | 0.75 |
| HD bucket 2,0 t/m ³ (3,370 lb/yd ³) | 750 | 0.98 | 625 | 0.82 | 550 | 0.72 |

EC140DL with 2 450 kg (5,400 lb) counterweight Quick Coupler Boom, Quick Coupler

| Arm | 2,1 m (6' 11") | | 4,6 m (15' 1") Mono-Boom | | 3,0 m (9' 10") | |
|--|----------------|-----------------|--------------------------|-----------------|----------------|-----------------|
| | liter | yd ³ | liter | yd ³ | liter | yd ³ |
| GP bucket 1,5 t/m ³ (2,530 lb/yd ³) | 875 | 1.14 | 725 | 0.95 | 625 | 0.82 |
| GP bucket 1,8 t/m ³ (3,030 lb/yd ³) | 775 | 1.01 | 650 | 0.85 | 550 | 0.72 |
| HD bucket 1,8 t/m ³ (3,030 lb/yd ³) | 725 | 0.95 | 600 | 0.78 | 525 | 0.69 |
| HD bucket 2,0 t/m ³ (3,370 lb/yd ³) | 675 | 0.88 | 575 | 0.75 | 475 | 0.62 |

EC160DL with 3 200 kg (7,060 lb) counterweight with Direct Fit Boom, Direct Fit

| Arm | 2,3 m (7' 7") | | 5,2 m (17' 1") | | 3,0 m (9' 10") | |
|--|---------------|-----------------|----------------|-----------------|----------------|-----------------|
| | liter | yd ³ | liter | yd ³ | liter | yd ³ |
| GP bucket 1,5 t/m ³ (2,530 lb/yd ³) | 1 125 | 1.47 | 1 000 | 1.31 | 875 | 1.14 |
| GP bucket 1,8 t/m ³ (3,030 lb/yd ³) | 1 000 | 1.31 | 900 | 1.18 | 775 | 1.01 |
| HD bucket 1,8 t/m ³ (3,030 lb/yd ³) | 950 | 1.24 | 850 | 1.11 | 750 | 0.98 |
| HD bucket 2,0 t/m ³ (3,370 lb/yd ³) | 900 | 1.18 | 800 | 1.05 | 700 | 0.92 |

EC160DL with 3 200 kg (7,060 lb) counterweight with Quick Coupler Boom, Quick Coupler

| Arm | 2,3 m (7' 7") | | 5,2 m (17' 1") | | 3,0 m (9' 10") | |
|--|---------------|-----------------|----------------|-----------------|----------------|-----------------|
| | liter | yd ³ | liter | yd ³ | liter | yd ³ |
| GP bucket 1,5 t/m ³ (2,530 lb/yd ³) | 1 025 | 1.34 | 900 | 1.08 | 775 | 1.01 |
| GP bucket 1,8 t/m ³ (3,030 lb/yd ³) | 900 | 1.18 | 800 | 1.05 | 675 | 0.88 |
| HD bucket 1,8 t/m ³ (3,030 lb/yd ³) | 850 | 1.11 | 750 | 0.98 | 650 | 0.85 |
| HD bucket 2,0 t/m ³ (3,370 lb/yd ³) | 800 | 1.05 | 700 | 0.92 | 600 | 0.78 |

EC220DL with 4 200 kg (9,260 lb) counterweight with Direct Fit Boom, Direct Fit

| Arm | 2,5 m (8'2") | | 5,7 m (18'8") | | 3,5 m (11'6") | |
|--|--------------|-----------------|---------------|-----------------|---------------|-----------------|
| | liter | yd ³ | liter | yd ³ | liter | yd ³ |
| GP bucket 1,5 t/m ³ (2,530 lb/yd ³) | 1 500 | 1.96 | 1 350 | 1.77 | 1 200 | 1.57 |
| GP bucket 1,8 t/m ³ (3,030 lb/yd ³) | 1 325 | 1.73 | 1 200 | 1.57 | 1 075 | 1.41 |
| HD bucket 1,8 t/m ³ (3,030 lb/yd ³) | 1 250 | 1.64 | 1 125 | 1.47 | 1 000 | 1.31 |
| HD bucket 2,0 t/m ³ (3,370 lb/yd ³) | 1 175 | 1.54 | 1 050 | 1.37 | 950 | 1.24 |

EC220DL with 4 200 kg (9,260 lb) counterweight with Quick Coupler Boom, Quick Coupler

| Arm | 2,5 m (8'2") | | 5,7 m (18'8") | | 3,5 m (11'6") | |
|--|--------------|-----------------|---------------|-----------------|---------------|-----------------|
| | liter | yd ³ | liter | yd ³ | liter | yd ³ |
| GP bucket 1,5 t/m ³ (2,530 lb/yd ³) | 1 350 | 1.77 | 1 225 | 1.60 | 1 075 | 1.41 |
| GP bucket 1,8 t/m ³ (3,030 lb/yd ³) | 1 200 | 1.57 | 1 075 | 1.41 | 950 | 1.24 |
| HD bucket 1,8 t/m ³ (3,030 lb/yd ³) | 1 150 | 1.50 | 1 025 | 1.34 | 900 | 1.18 |
| HD bucket 2,0 t/m ³ (3,370 lb/yd ³) | 1 075 | 1.41 | 950 | 1.24 | 825 | 1.08 |

- Note: 1. Bucket size based on ISO 7451, heaped material with a 1:1 angle of repose.
 2. "Max permitted sizes" are for reference only and are not necessarily available from the factory.
 3. Bucket widths are less than bucket's tip radius.

SPECIFICATIONS.

MACHINE WEIGHTS AND GROUND PRESSURE

| Description Units | Shoe width | | Operating weight | | Ground pressure | | Overall width | | Operating weight | | Ground pressure | | Overall width | |
|---------------------------------|------------|----|--|--------|-----------------|-----|---------------|--|------------------|--------|-----------------|-----|---------------|---------|
| | mm | in | kg | lb | kPa | psi | mm | in | kg | lb | kPa | psi | mm | in |
| EC140DL | | | 4,6 m (15' 1") boom, 2,5 m (8' 2") arm, 390 kg (860 lb) bucket, 2 100 kg (4,630 lb) counterweight | | | | | 4,6 m (15' 1") 2 piece boom, 2,5 m (8' 2") arm, 390 kg (860 lb) bucket, 2 100 kg (4,630 lb) counterweight | | | | | | |
| Triple grouser | 500 | 20 | 13 160 | 29,020 | 41,2 | 6.0 | 2 490 | 8' 2" | 13 510 | 29,790 | 42,2 | 6.1 | 2 490 | 8' 2" |
| | 600 | 24 | 13 360 | 29,460 | 35,3 | 5.1 | 2 590 | 8' 6" | 13 710 | 30,230 | 36,3 | 5.3 | 2 590 | 8' 6" |
| | 750 | 30 | 13 750 | 30,320 | 28,4 | 4.1 | 2 740 | 9' 0" | 14 100 | 31,090 | 29,4 | 4.3 | 2 740 | 9' 0" |
| Triple grouser HD | 600 | 24 | 13 430 | 29,610 | 35,3 | 5.1 | 2 590 | 8' 6" | 13 780 | 30,380 | 36,3 | 5.3 | 2 590 | 8' 6" |
| | 700 | 28 | 13 630 | 30,050 | 30,4 | 4.4 | 2 690 | 8' 10" | 13 980 | 30,830 | 31,4 | 4.6 | 2 690 | 8' 10" |
| Rubber grouser | 500 | 20 | 13 200 | 29,110 | 41,2 | 6.0 | 2 490 | 8' 2" | 13 540 | 29,860 | 42,2 | 6.1 | 2 490 | 8' 2" |
| EC140DL with Dozer Blade | | | 4,6 m (15' 1") boom, 2,5 m (8' 2") arm, 390 kg (860 lb) bucket, 2 100 kg (4,630 lb) counterweight | | | | | 4,6 m (15' 1") 2 piece boom, 2,5 m (8' 2") arm, 390 kg (860 lb) bucket, 2 100 kg (4,630 lb) counterweight | | | | | | |
| Triple grouser | 500 | 20 | 14 100 | 31,090 | 44,1 | 6.4 | 2 490 | 8' 2" | 14 440 | 31,840 | 45,1 | 6.5 | 2 490 | 8' 2" |
| | 600 | 24 | 14 290 | 31,510 | 37,3 | 5.4 | 2 590 | 8' 6" | 14 640 | 32,280 | 38,2 | 5.5 | 2 590 | 8' 6" |
| | 750 | 30 | 14 690 | 32,390 | 30,4 | 4.4 | 2 740 | 9' 0" | 15 030 | 33,140 | 31,4 | 4.6 | 2 740 | 9' 0" |
| Triple grouser HD | 600 | 24 | 14 370 | 31,690 | 37,3 | 5.4 | 2 590 | 8' 6" | 14 710 | 32,440 | 38,2 | 5.5 | 2 590 | 8' 6" |
| | 700 | 28 | 14 570 | 32,130 | 32,4 | 4.7 | 2 690 | 8' 10" | 14 910 | 32,880 | 33,3 | 4.8 | 2 690 | 8' 10" |
| Rubber grouser | 500 | 20 | 14 130 | 31,160 | 44,1 | 6.4 | 2 490 | 8' 2" | 14 480 | 31,930 | 45,1 | 6.5 | 2 490 | 8' 2" |
| EC140DL | | | 4,6 m (15' 1") boom, 2,5 m (8' 2") arm, 390 kg (860 lb) bucket, 2 450 kg (5,400 lb) counterweight | | | | | 4,6 m (15' 1") 2 piece boom, 2,5 m (8' 2") arm, 390 kg (860 lb) bucket, 2 450 kg (5,400 lb) counterweight | | | | | | |
| Triple grouser | 500 | 20 | 13 510 | 29,790 | 42,2 | 6.1 | 2 490 | 8' 2" | 13 860 | 30,560 | 43,1 | 6.3 | 2 490 | 8' 2" |
| | 600 | 24 | 13 710 | 30,230 | 36,3 | 5.3 | 2 590 | 8' 6" | 14 060 | 31,000 | 37,3 | 5.4 | 2 590 | 8' 6" |
| | 750 | 30 | 14 100 | 31,090 | 29,4 | 4.3 | 2 740 | 9' 0" | 14 450 | 31,860 | 30,4 | 4.4 | 2 740 | 9' 0" |
| Triple grouser HD | 600 | 24 | 13 780 | 30,380 | 36,3 | 5.3 | 2 590 | 8' 6" | 14 130 | 31,160 | 37,3 | 5.4 | 2 590 | 8' 6" |
| | 700 | 28 | 13 980 | 30,830 | 31,4 | 4.6 | 2 690 | 8' 10" | 14 330 | 31,600 | 32,4 | 4.7 | 2 690 | 8' 10" |
| Rubber grouser | 500 | 20 | 13 550 | 29,880 | 42,2 | 6.1 | 2 490 | 8' 2" | 13 890 | 30,630 | 43,1 | 6.3 | 2 490 | 8' 2" |
| EC140DL with Dozer Blade | | | 4,6 m (15' 1") boom, 2,5 m (8' 2") arm, 390 kg (860 lb) bucket, 2 450 kg (5,400 lb) counterweight | | | | | 4,6 m (15' 1") 2 piece boom, 2,5 m (8' 2") arm, 390 kg (860 lb) bucket, 2 450 kg (5,400 lb) counterweight | | | | | | |
| Triple grouser | 500 | 20 | 14 450 | 31,860 | 45,1 | 6.5 | 2 490 | 8' 2" | 14 790 | 32,610 | 46,1 | 6.7 | 2 490 | 8' 2" |
| | 600 | 24 | 14 640 | 32,280 | 38,2 | 5.5 | 2 590 | 8' 6" | 14 990 | 33,050 | 39,2 | 5.7 | 2 590 | 8' 6" |
| | 750 | 30 | 15 040 | 33,160 | 31,4 | 4.6 | 2 740 | 9' 0" | 15 380 | 33,910 | 32,4 | 4.7 | 2 740 | 9' 0" |
| Triple grouser HD | 600 | 24 | 14 720 | 32,460 | 38,2 | 5.5 | 2 590 | 8' 6" | 15 060 | 33,210 | 39,2 | 5.7 | 2 590 | 8' 6" |
| | 700 | 28 | 14 920 | 32,900 | 33,3 | 4.8 | 2 690 | 8' 10" | 15 260 | 33,650 | 34,3 | 5.0 | 2 690 | 8' 10" |
| Rubber grouser | 500 | 20 | 14 480 | 31,930 | 45,1 | 6.5 | 2 490 | 8' 2" | 14 830 | 32,700 | 46,1 | 6.7 | 2 490 | 8' 2" |
| EC160DL | | | 5,2 m (17' 1") boom, 2,6 m (8' 6") arm, 470 kg (1,040 lb) bucket, 3 200 kg (7,060 lb) counterweight | | | | | | | | | | | |
| Triple grouser | 500 | 20 | 17 150 | 37,820 | 49,0 | 7.1 | 2 490 | 8' 2" | | | | | | |
| | 600 | 24 | 17 380 | 38,320 | 41,2 | 6.0 | 2 590 | 8' 6" | | | | | | |
| | 700 | 28 | 17 620 | 38,850 | 35,3 | 5.1 | 2 690 | 8' 10" | | | | | | |
| | 800 | 32 | 18 010 | 39,710 | 31,4 | 4.6 | 2 790 | 9' 2" | | | | | | |
| | 900 | 36 | 18 280 | 40,310 | 28,4 | 4.1 | 2 990 | 9' 10" | | | | | | |
| EC160DL with Dozer Blade | | | 5,2 m (17' 1") boom, 2,6 m (8' 6") arm, 470 kg (1,040 lb) bucket, 3 200 kg (7,060 lb) counterweight | | | | | | | | | | | |
| Triple grouser | 500 | 20 | 18 310 | 40,370 | 52,0 | 7.5 | 2 490 | 8' 2" | | | | | | |
| | 600 | 24 | 18 540 | 40,880 | 44,1 | 6.4 | 2 590 | 8' 6" | | | | | | |
| | 700 | 28 | 18 780 | 41,410 | 38,2 | 5.5 | 2 690 | 8' 10" | | | | | | |
| | 800 | 32 | 19 170 | 42,270 | 34,3 | 5.0 | 2 790 | 9' 2" | | | | | | |
| | 900 | 36 | 19 440 | 42,870 | 30,4 | 4.4 | 2 990 | 9' 10" | | | | | | |
| EC220DL | | | 5,7 m (18' 8") boom, 2,9 m (9' 6") arm, 776 kg (1,710 lb) bucket, 4 200 kg (9,260 lb) counterweight | | | | | 5,7 m (18' 3") 2 piece boom, 2,9 m (9' 6") arm, 776 kg (1,710 lb) bucket, 4 200 kg (9,260 lb) counterweight | | | | | | |
| Triple grouser | 500 | 20 | 21 870 | 48,220 | 54,9 | 8.0 | 2 890 | 9' 6" | 22 560 | 49,740 | 55,9 | 8.1 | 2 890 | 9' 6" |
| | 600 | 24 | 22 130 | 48,800 | 46,1 | 6.7 | 2 990 | 9' 10" | 22 810 | 50,300 | 47,1 | 6.8 | 2 990 | 9' 10" |
| | 700 | 28 | 22 580 | 49,790 | 40,2 | 5.8 | 3 090 | 10' 2" | 23 260 | 51,290 | 41,2 | 6.0 | 3 090 | 10' 2" |
| | 800 | 32 | 22 860 | 50,410 | 35,3 | 5.1 | 3 190 | 10' 6" | 23 550 | 51,930 | 36,3 | 5.3 | 3 190 | 10' 6" |
| | 900 | 36 | 23 150 | 51,050 | 32,4 | 4.7 | 3 290 | 10' 10" | 23 830 | 52,550 | 33,3 | 4.8 | 3 290 | 10' 10" |
| Triple grouser HD | 600 | 24 | 22 300 | 49,170 | 46,1 | 6.7 | 2 990 | 9' 10" | 22 980 | 50,670 | 48,0 | 7.0 | 2 990 | 9' 10" |
| Double grouser | 700 | 28 | 22 860 | 50,410 | 40,2 | 5.8 | 3 090 | 10' 2" | 23 550 | 51,930 | 42,2 | 6.1 | 3 090 | 10' 2" |
| EC220DLR | | | 8,85 m (29' 0") boom, 6,25 m (20' 6") arm, 452 kg (1,000 lb) bucket, 5 000 kg (11,025 lb) counterweight | | | | | | | | | | | |
| Triple grouser | 800 | 32 | 23 860 | 52,610 | 37,3 | 5.4 | 3 190 | 10' 6" | | | | | | |
| | 900 | 36 | 24 140 | 53,230 | 33,3 | 4.8 | 3 290 | 10' 10" | | | | | | |

DIMENSIONS

Boom

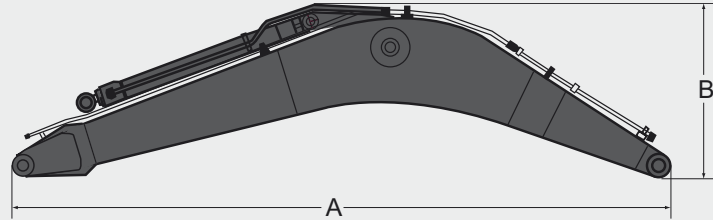

| EC140D | | | |
|-------------|---------|----------------|----------------|
| Description | Unit | mono | 2-piece |
| Boom | m (in) | 4,6 (15' 1") | 4,6 (15' 1") |
| Length (A) | mm (in) | 4 770 (15' 8") | 4 765 (15' 8") |
| Height (B) | mm (in) | 1 370 (4' 6") | 1 225 (4' 0") |
| Width | mm (in) | 545 (1' 9") | 545 (1' 9") |
| Weight | kg (lb) | 1 100 (2,430) | 1 400 (3,090) |

| EC160D | |
|-------------|---------|
| Description | Unit |
| Boom | m (in) |
| Length (A) | mm (in) |
| Height (B) | mm (in) |
| Width | mm (in) |
| Weight | kg (lb) |

| EC220D | | | | | |
|-------------|---------|-----------------|-----------------|----------------|----------------|
| Description | Unit | mono | mono | 2-piece | Long reach |
| Boom | m (in) | 5,7 GP (18' 8") | 5,7 HD (18' 8") | 5,57 (18' 3") | 8,85 (29' 0") |
| Length (A) | mm (in) | 5 910 (19' 5") | 5 910 (19' 5") | 5 780 (19' 0") | 9 060 (29' 9") |
| Height (B) | mm (in) | 1 585 (5' 2") | 1 585 (5' 2") | 1 570 (5' 2") | 1 460 (4' 9") |
| Width | mm (in) | 670 (2' 2") | 670 (2' 2") | 670 (2' 2") | 670 (2' 2") |
| Weight | kg (lb) | 1 995 (4,400) | 2 135 (4,710) | 2 585 (5,700) | 2 510 (5,530) |

Arm

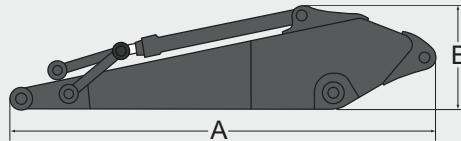

| EC140D | | | |
|-------------|---------|---------------|----------------|
| Description | Unit | | |
| Arm | m (in) | 2,1 (6' 11") | 2,5 (8' 2") |
| Length (A) | mm (in) | 2 800 (9' 2") | 3 200 (10' 6") |
| Height (B) | mm (in) | 710 (2' 4") | 710 (2' 4") |
| Width | mm (in) | 300 (1' 0") | 300 (1' 0") |
| Weight | kg (lb) | 555 (1,220) | 625 (1,380) |

| EC160D | | | |
|-------------|---------|----------------|----------------|
| Description | Unit | | |
| Arm | m (in) | 2,3 (7' 7") | 2,6 (8' 6") |
| Length (A) | mm (in) | 3 240 (10' 8") | 3 500 (11' 6") |
| Height (B) | mm (in) | 855 (2' 10") | 855 (2' 10") |
| Width | mm (in) | 395 (1' 4") | 395 (1' 4") |
| Weight | kg (lb) | 790 (1,740) | 800 (1,760) |

| EC220D | | | | | |
|-------------|---------|----------------|-----------------|-----------------|-----------------|
| Description | Unit | | | | |
| Arm | m (in) | 2,5 HD (8' 2") | 2,9 GP (9' 6") | 2,9 HD (9' 6") | 3,5 GP (11' 6") |
| Length (A) | mm (in) | 3 525 (11' 7") | 3 910 (12' 10") | 3 910 (12' 10") | 4 540 (14' 11") |
| Height (B) | mm (in) | 860 (2' 10") | 860 (2' 10") | 860 (2' 10") | 855 (2' 10") |
| Width | mm (in) | 440 (1' 5") | 440 (1' 5") | 440 (1' 5") | 440 (1' 5") |
| Weight | kg (lb) | 1 126 (2,480) | 1 121 (2,470) | 1 176 (2,590) | 1 226 (2,700) |

Boom: Includes cylinder, piping and pin, excludes boom cyl. Pin. Arm: Includes cylinder, linkage and pin.

SPECIFICATIONS.

DIMENSIONS - EC140DL and EC160DL

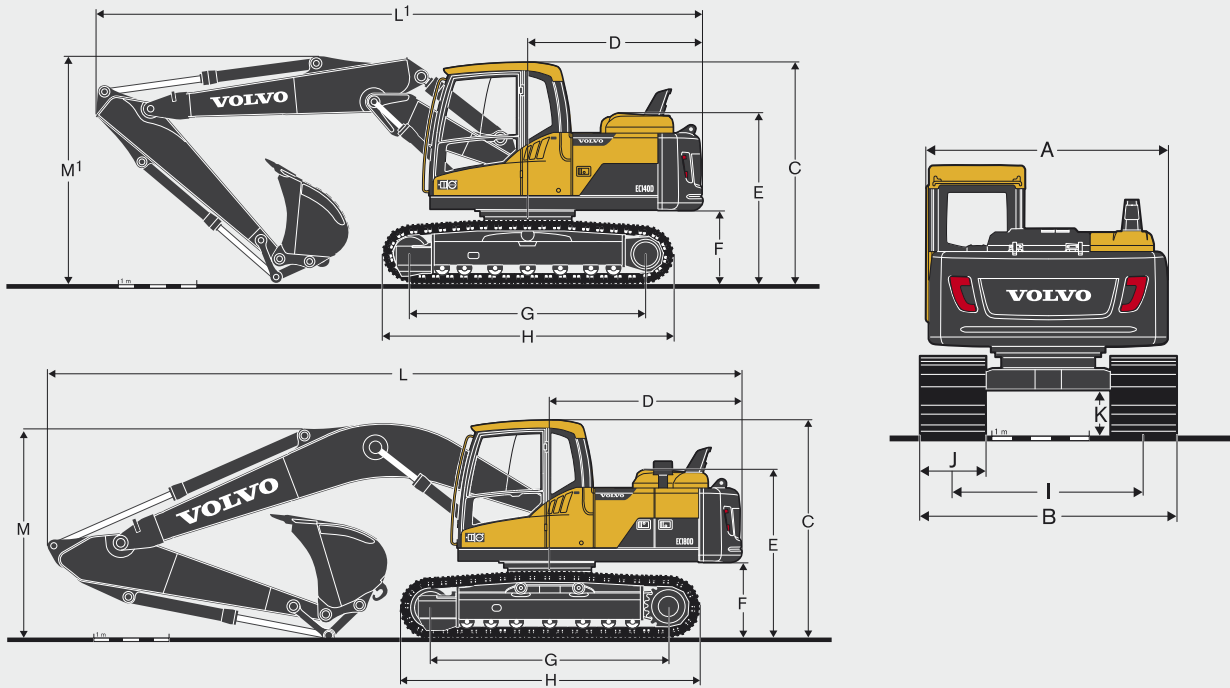

| Description | Unit | EC140DL | | | EC160DL | | |
|-------------------------------------|-------------|---|----------------|----------------|----------------|----------------|-----------------|
| Boom | m, (ft-in) | 4,6 (15' 1") mono or 4,6 (15' 1") 2-piece | | | 5,2 (17' 1") | | |
| Arm | m, (ft-in) | 2,1 (6' 11") | 2,5 (8' 2") | 3,0 (9' 10") | 2,3 (7' 7") | 2,6 (8' 6") | 3,0 (9' 10") |
| A. Overall width of upper structure | mm, (ft-in) | 2 490 (8' 2") | 2 490 (8' 2") | 2 490 (8' 2") | 2 490 (8' 2") | 2 490 (8' 2") | 2 490 (8' 2") |
| B. Overall width | mm, (ft-in) | 2 590 (8' 6") | 2 590 (8' 6") | 2 590 (8' 6") | 2 590 (8' 6") | 2 590 (8' 6") | 2 590 (8' 6") |
| C. Overall height of cab | mm, (ft-in) | 2 800 (9' 2") | 2 800 (9' 2") | 2 800 (9' 2") | 2 900 (9' 6") | 2 900 (9' 6") | 2 900 (9' 6") |
| D. Tail slew radius | mm, (ft-in) | 2 200 (7' 3") | 2 200 (7' 3") | 2 200 (7' 3") | 2 550 (8' 4") | 2 550 (8' 4") | 2 550 (8' 4") |
| E. Overall height of engine hood | mm, (ft-in) | 2 020 (6' 8") | 2 020 (6' 8") | 2 020 (6' 8") | 2 235 (7' 4") | 2 235 (7' 4") | 2 235 (7' 4") |
| F. Counterweight clearance * | mm, (ft-in) | 920 (3' 0") | 920 (3' 0") | 920 (3' 0") | 1 010 (3' 4") | 1 010 (3' 4") | 1 010 (3' 4") |
| G. Tumbler length | mm, (ft-in) | 3 040 (10' 0") | 3 040 (10' 0") | 3 040 (10' 0") | 3 180 (10' 5") | 3 180 (10' 5") | 3 180 (10' 5") |
| H. Track length | mm, (ft-in) | 3 760 (12' 4") | 3 760 (12' 4") | 3 760 (12' 4") | 3 980 (13' 1") | 3 980 (13' 1") | 3 980 (13' 1") |
| I. Track gauge | mm, (ft-in) | 1 990 (6' 6") | 1 990 (6' 6") | 1 990 (6' 6") | 1 990 (6' 6") | 1 990 (6' 6") | 1 990 (6' 6") |
| J. Shoe width | mm, (in) | 600 (24") | 600 (24") | 600 (24") | 600 (24") | 600 (24") | 600 (24") |
| K. Min. ground clearance * | mm, (ft-in) | 436 (1' 5") | 436 (1' 5") | 436 (1' 5") | 460 (1' 6") | 460 (1' 6") | 460 (1' 6") |
| L. Overall length | mm, (ft-in) | 7 630 (25' 0") | 7 630 (25' 0") | 7 630 (25' 0") | 8 880 (29' 2") | 8 990 (28' 9") | 8 810 (28' 11") |
| L'. Overall length | mm, (ft-in) | 7 610 (25' 0") | 7 550 (24' 9") | 7 320 (24' 0") | - | - | - |
| M. Overall height of boom | mm, (ft-in) | 2 710 (8' 11") | 2 830 (9' 3") | 3 210 (10' 6") | 2 980 (9' 9") | 2 900 (9' 6") | 3 020 (9' 11") |
| M'. Overall height of boom | mm, (ft-in) | 2 720 (8' 11") | 2 950 (9' 8") | 3 350 (11' 0") | - | - | - |

* Without shoe grouser / 1 2-piece boom

| Front dozer blade | Unit | EC140DL | EC160DL |
|-------------------|-------------|---------------|---------------|
| A. Height | m, (ft-in) | 585 (1' 11") | 452 (1' 6") |
| Width | mm, (ft-in) | 2 590 (8' 6") | 2 800 (9' 2") |
| Weight | kg, (lb) | 458 (1,010) | 595 (1,310) |
| B. Lift height | mm, (ft-in) | 478 (1' 7") | 571 (1' 10") |
| C. Digging depth | mm, (ft-in) | 601 (2' 0") | 735 (2' 5") |

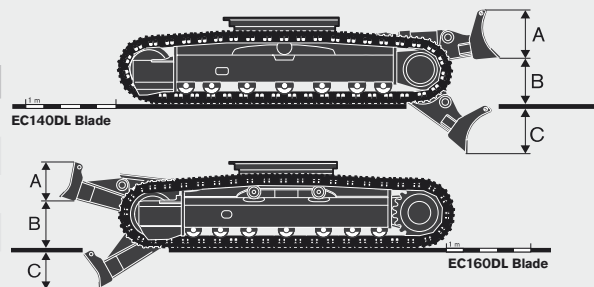

DIMENSIONS - EC220DL and EC220DLR

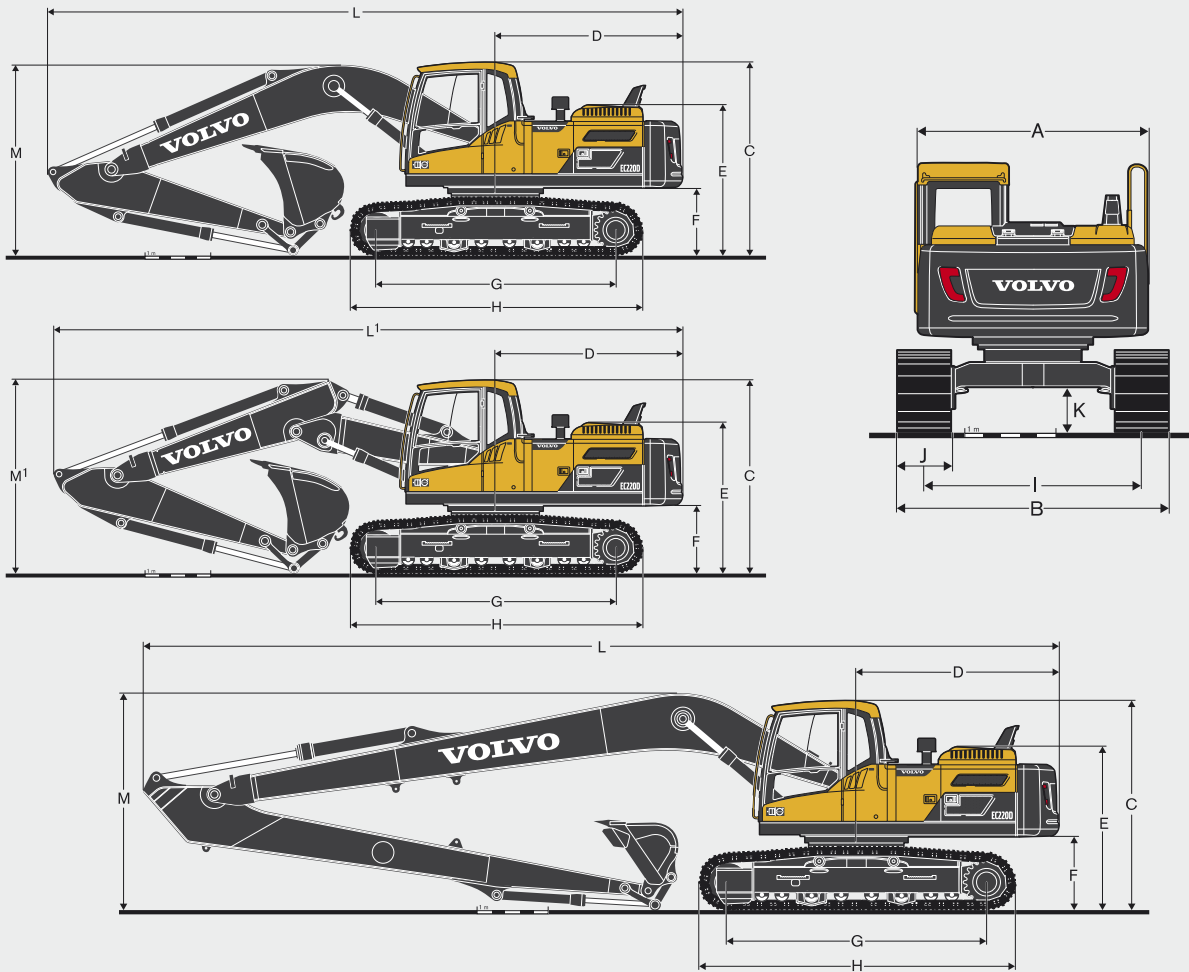

| Description | Unit | EC220DL | | | EC220DLR |
|-------------------------------------|-------------|--|----------------|-----------------|-----------------|
| Boom | m, (ft-in) | 5,7 (18' 8") mono or 5,57 (18' 3") 2-piece | | | 8,85 (29' 0") |
| Arm | m, (ft-in) | 2,5 (8' 2") | 2,9 (9' 6") | 3,5 (11' 6") | 6,25 (20' 6") |
| A. Overall width of upper structure | mm, (ft-in) | 2 540 (8' 4") | 2 540 (8' 4") | 2 540 (8' 4") | 2 540 (8' 4") |
| B. Overall width | mm, (ft-in) | 2 990 (9' 10") | 2 990 (9' 10") | 2 990 (9' 10") | 3 190 (10' 6") |
| C. Overall height of cab | mm, (ft-in) | 2 930 (9' 7") | 2 930 (9' 7") | 2 930 (9' 7") | 2 930 (9' 7") |
| D. Tail slew radius | mm, (ft-in) | 2 850 (9' 4") | 2 850 (9' 4") | 2 850 (9' 4") | 2 850 (9' 4") |
| E. Overall height of engine hood | mm, (ft-in) | 2 305 (7' 7") | 2 305 (7' 7") | 2 305 (7' 7") | 2 305 (7' 7") |
| F. Counterweight clearance * | mm, (ft-in) | 1 025 (3' 4") | 1 025 (3' 4") | 1 025 (3' 4") | 1 025 (3' 4") |
| G. Tumbler length | mm, (ft-in) | 3 660 (12' 0") | 3 660 (12' 0") | 3 660 (12' 0") | 3 660 (12' 0") |
| H. Track length | mm, (ft-in) | 4 460 (14' 8") | 4 460 (14' 8") | 4 460 (14' 8") | 4 460 (14' 8") |
| I. Track gauge | mm, (ft-in) | 2 390 (7' 10") | 2 390 (7' 10") | 2 390 (7' 10") | 2 390 (7' 10") |
| J. Shoe width | mm, (in) | 600 (24") | 600 (24") | 600 (24") | 800 (32") |
| K. Min. ground clearance * | mm, (ft-in) | 460 (1' 6") | 460 (1' 6") | 460 (1' 6") | 460 (1' 6") |
| L. Overall length | mm, (ft-in) | 9 745 (32' 0") | 9 690 (31' 9") | 9 720 (31' 11") | 12 880 (42' 3") |
| L'. Overall length | mm, (ft-in) | 9 610 (31' 6") | 9 570 (31' 5") | 9 560 (31' 4") | - |
| M. Overall height of boom | mm, (ft-in) | 3 080 (10' 1") | 2 940 (9' 8") | 3 260 (10' 8") | 3 055 (10' 0") |
| M'. Overall height of boom | mm, (ft-in) | 3 065 (10' 1") | 2 960 (9' 9") | 3 310 (10' 10") | - |

* Without shoe grouser / 1 2-piece boom

SPECIFICATIONS.

WORKING RANGES

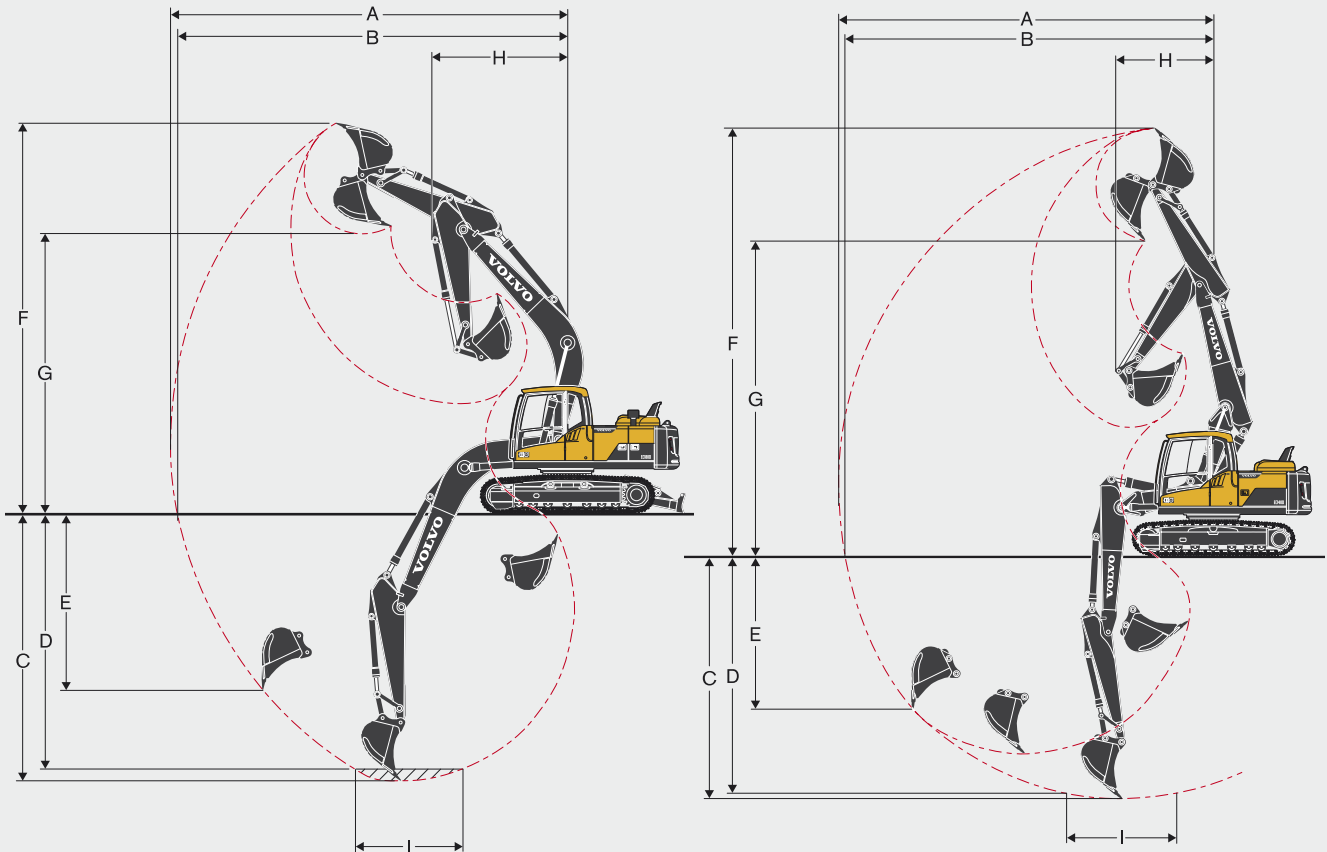

| Description | Unit | EC140DL | | | | | | EC160DL | | | |
|---|-------------|-------------------|-----------------|-----------------|----------------------|-----------------|-----------------|-------------------|-----------------|----------------|---------------|
| | | 4,6 (15' 1") mono | | | 4,6 (15' 1") 2-piece | | | 5,2 (17' 1") mono | | | |
| Boom | m, (ft-in) | 4,6 (15' 1") mono | | | 4,6 (15' 1") 2-piece | | | 5,2 (17' 1") mono | | | |
| Arm | m, (ft-in) | 2,1 (6' 11") | 2,5 (8' 2") | 3,0 (9' 10") | 2,1 (6' 11") | 2,5 (8' 2") | 3,0 (9' 10") | 2,3 (7' 7") | 2,6 (8' 6") | 3,0 (9' 10") | |
| A. Max. digging reach | mm, (ft-in) | 7 960 (26' 1") | 8 330 (27' 4") | 8 820 (28' 11") | 8 050 (26' 5") | 8 440 (27' 8") | 8 930 (29' 4") | 8 650 (28' 5") | 8 970 (29' 5") | 9 340 (30' 8") | |
| B. Max. digging reach on ground | mm, (ft-in) | 7 810 (25' 7") | 8 190 (26' 10") | 8 690 (28' 6") | 7 910 (25' 11") | 8 300 (27' 3") | 8 800 (28' 10") | 8 490 (27' 10") | 8 810 (28' 11") | 9 180 (30' 1") | |
| C. Max. digging depth | mm, (ft-in) | 5 130 (16' 10") | 5 530 (18' 2") | 6 030 (19' 9") | 5 060 (16' 7") | 5 450 (17' 11") | 5 950 (19' 6") | 5 740 (18' 10") | 6 040 (19' 10") | 6 440 (21' 2") | |
| D. Max. digging depth (l = 2,440 m, (8') level) | mm, (ft-in) | 4 880 (16' 0") | 5 310 (17' 5") | 5 850 (19' 2") | 4 930 (16' 2") | 5 340 (17' 6") | 5 850 (19' 2") | 5 420 (17' 9") | 5 770 (18' 11") | 6 200 (20' 4") | |
| E. Max. vertical wall digging depth | mm, (ft-in) | 4 580 (15' 0") | 4 970 (16' 4") | 5 510 (18' 1") | 4 290 (14' 1") | 4 680 (15' 4") | 5 180 (17' 0") | 4 480 (14' 8") | 4 950 (16' 3") | 5 380 (17' 8") | |
| F. Max. cutting height | mm, (ft-in) | 8 190 (26' 10") | 8 420 (27' 7") | 8 770 (28' 9") | 9 260 (30' 5") | 9 620 (31' 7") | 10 090 (33' 1") | 8 570 (28' 1") | 8 820 (28' 11") | 9 030 (29' 8") | |
| G. Max. dumping height | mm, (ft-in) | 5 770 (18' 11") | 6 010 (19' 9") | 6 350 (20' 10") | 6 800 (22' 4") | 7 160 (23' 6") | 7 640 (25' 1") | 6 110 (20' 1") | 6 340 (20' 10") | 6 540 (21' 5") | |
| H. Min. front slew radius | mm, (ft-in) | 2 540 (8' 4") | 2 600 (8' 6") | 2 830 (9' 3") | 1 930 (6' 4") | 2 190 (7' 2") | 2 620 (8' 7") | 3 070 (10' 1") | 3 070 (10' 1") | 3 070 (10' 1") | |
| Digging forces with direct fit bucket | | | | | | | | | | | |
| Bucket radius | mm, (in) | 1 250 (49") | 1 250 (49") | 1 250 (49") | 1 250 (49") | 1 250 (49") | 1 250 (49") | 1 315 (52") | 1 315 (52") | 1 315 (52") | |
| Breakout force - bucket | | | | | | | | | | | |
| Normal | SAE J1179 | kN, (lb) | 82,4 (18,560) | 82,4 (18,560) | 82,4 (18,560) | 82,4 (18,560) | 82,4 (18,560) | 101,9 (22,900) | 101,9 (22,900) | 101,9 (22,900) | |
| Power boost | SAE J1179 | kN, (lb) | 87,3 (19,620) | 87,3 (19,620) | 87,3 (19,620) | 87,3 (19,620) | 87,3 (19,620) | 107,7 (24,210) | 107,7 (24,210) | 107,7 (24,210) | |
| Normal | ISO 6015 | kN, (lb) | 93,2 (20,950) | 93,2 (20,950) | 93,2 (20,950) | 93,2 (20,950) | 93,2 (20,950) | 114,7 (25,780) | 114,7 (25,780) | 114,7 (25,780) | |
| Power boost | ISO 6015 | kN, (lb) | 98,1 (22,050) | 98,1 (22,050) | 98,1 (22,050) | 98,1 (22,050) | 98,1 (22,050) | 121,3 (27,260) | 121,3 (27,260) | 121,3 (27,260) | |
| Tearout force - dipper arm | | | | | | | | | | | |
| Normal | SAE J1179 | kN, (lb) | 69,6 (15,660) | 61,8 (13,890) | 54,9 (12,350) | 69,6 (15,660) | 61,8 (13,890) | 54,9 (12,350) | 90,4 (20,320) | 80,4 (18,070) | 72,8 (16,360) |
| Power boost | SAE J1179 | kN, (lb) | 73,5 (16,540) | 65,7 (14,770) | 58,8 (13,230) | 73,5 (16,540) | 65,7 (14,770) | 58,8 (13,230) | 95,5 (21,470) | 85 (19,110) | 76,9 (17,280) |
| Normal | ISO 6015 | kN, (lb) | 71,6 (16,100) | 63,7 (14,330) | 56,9 (12,790) | 71,6 (16,100) | 63,7 (14,330) | 56,9 (12,790) | 92,9 (20,880) | 82,3 (18,500) | 74,3 (16,700) |
| Power boost | ISO 6015 | kN, (lb) | 75,5 (16,980) | 67,7 (15,210) | 59,8 (13,450) | 75,5 (16,980) | 67,7 (15,210) | 59,8 (13,450) | 98,2 (22,070) | 87 (19,560) | 78,6 (17,670) |
| Rotation angle, bucket | ° | 174 | | | 174 | | | 174 | | | 183 |

WORKING RANGES

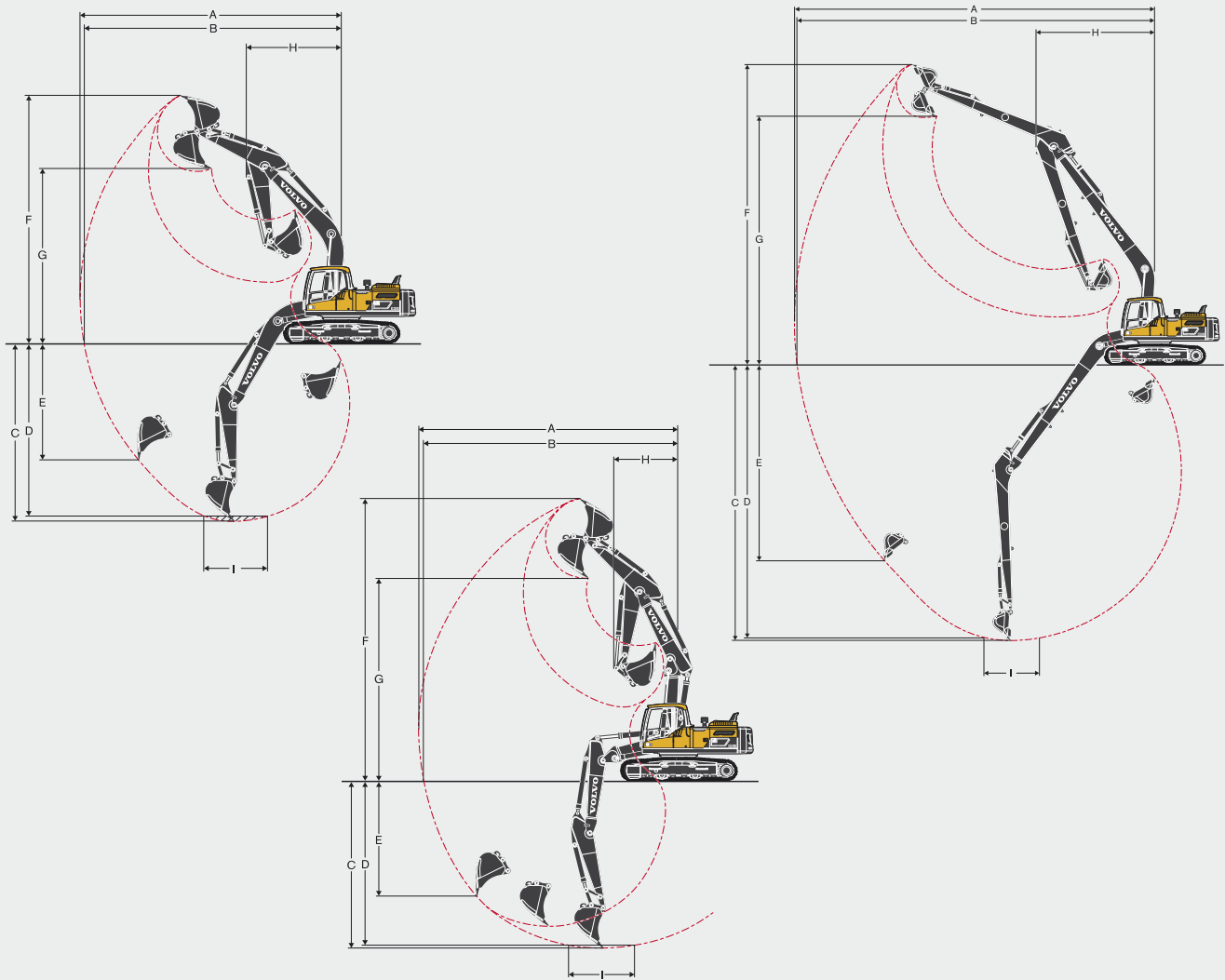

| Description | Unit | EC220DL | | | | | | | |
|---|-------------|-------------------|-----------------|-----------------|-----------------------|-----------------|------------------|------------------|-------------|
| | | 5,7 (18' 8") mono | | | 5,57 (18' 3") 2-piece | | | EC220DLR | |
| Boom | m, (ft-in) | | | | | | | 8,85 (29' 0") | |
| Arm | m, (ft-in) | 2,5 (8' 2") | 2,9 (9' 6") | 3,5 (11' 6") | 2,5 (8' 2") | 2,9 (9' 6") | 3,5 (11' 6") | 6,25 (20' 6") | |
| A. Max. digging reach | mm, (ft-in) | 9 550 (31' 4") | 9 930 (32' 7") | 10 390 (34' 1") | 9 450 (31' 0") | 9 840 (32' 3") | 10 310 (33' 10") | 15 800 (51' 10") | |
| B. Max. digging reach on ground | mm, (ft-in) | 9 380 (30' 9") | 9 770 (32' 1") | 10 240 (33' 7") | 9 280 (30' 5") | 9 670 (31' 9") | 10 150 (33' 4") | 15 700 (51' 6") | |
| C. Max. digging depth | mm, (ft-in) | 6 330 (20' 9") | 6 730 (22' 1") | 7 330 (24' 1") | 5 900 (19' 4") | 6 300 (20' 8") | 6 850 (22' 6") | 12 100 (39' 8") | |
| D. Max. digging depth (l = 2,440 m, (8') level) | mm, (ft-in) | 6 100 (20' 0") | 6 540 (21' 5") | 7 130 (23' 5") | 5 790 (19' 0") | 6 200 (20' 4") | 6 750 (22' 2") | 12 000 (39' 4") | |
| E. Max. vertical wall digging depth | mm, (ft-in) | 5 620 (18' 5") | 6 090 (20' 0") | 6 470 (21' 3") | 4 990 (16' 4") | 5 410 (17' 9") | 5 930 (19' 5") | 11 290 (37' 0") | |
| F. Max. cutting height | mm, (ft-in) | 9 220 (30' 3") | 9 460 (31' 0") | 9 460 (31' 0") | 10 380 (34' 1") | 10 710 (35' 2") | 10 920 (35' 10") | 13 300 (43' 8") | |
| G. Max. dumping height | mm, (ft-in) | 6 430 (21' 1") | 6 650 (21' 10") | 6 700 (22' 0") | 7 460 (24' 6") | 7 780 (25' 6") | 8 010 (26' 3") | 10 950 (35' 11") | |
| H. Min. front slew radius | mm, (ft-in) | 3 670 (12' 0") | 3 640 (11' 11") | 3 660 (12' 0") | 2 740 (8' 12") | 2 470 (8' 1") | 2 730 (8' 11") | 5 200 (17' 1") | |
| Digging forces with direct fit bucket | | | | | | | | | |
| Bucket radius | mm, (in) | 1 470 (58") | 1 470 (58") | 1 470 (58") | 1 470 (58") | 1 470 (58") | 1 470 (58") | 1 250 (49") | |
| Breakout force - bucket | | | | | | | | | |
| Normal | SAE J1179 | kN, (lb) | 130 (29,240) | 130 (29,240) | 130 (29,240) | 130 (29,240) | 130 (29,240) | 130 (29,240) | 68 (15,280) |
| Power boost | SAE J1179 | kN, (lb) | 137 (30,890) | 137 (30,890) | 137 (30,890) | 137 (30,890) | 137 (30,890) | 137 (30,890) | - |
| Normal | ISO 6015 | kN, (lb) | 145 (32,480) | 145 (32,480) | 145 (32,480) | 145 (32,480) | 145 (32,480) | 145 (32,480) | 77 (17,270) |
| Power boost | ISO 6015 | kN, (lb) | 153 (34,330) | 153 (34,330) | 153 (34,330) | 153 (34,330) | 153 (34,330) | 153 (34,330) | - |
| Tearout force - dipper arm | | | | | | | | | |
| Normal | SAE J1179 | kN, (lb) | 119 (26,640) | 102 (23,000) | 93 (20,880) | 119 (26,640) | 102 (23,000) | 93 (20,880) | 44 (9,920) |
| Power boost | SAE J1179 | kN, (lb) | 125 (28,160) | 108 (24,320) | 98 (22,070) | 125 (28,160) | 108 (24,320) | 98 (22,070) | - |
| Normal | ISO 6015 | kN, (lb) | 122 (27,340) | 105 (23,550) | 95 (21,300) | 122 (27,340) | 105 (23,550) | 95 (21,300) | 45 (10,050) |
| Power boost | ISO 6015 | kN, (lb) | 129 (28,890) | 111 (24,890) | 100 (22,510) | 129 (28,890) | 111 (24,890) | 100 (22,510) | - |
| Rotation angle, bucket | ° | 175 | | | | | | | |

EQUIPMENT.

STANDARD EQUIPMENT

| | EC140D | EC160D | EC220D |
|--|--------|--------|--------|
| Engine | | | |
| Turbocharged, 4 stroke diesel engine with water cooling, direct injection and charged air cooler that meets Tier 4i requirements | • | • | • |
| Air filter with indicator | • | • | • |
| Air intake heater | • | • | • |
| Cyclone pre-cleaner | • | • | • |
| Electric engine shut-off | • | • | • |
| Fuel filter and water separator | • | • | • |
| Alternator | • | • | • |
| Cooling system (50 deg. C) | • | • | • |
| Electric/Electronic control system | | | |
| Contronics | • | • | • |
| - Advanced mode control system | • | • | • |
| - Self-diagnostic system | • | • | • |
| CareTrack Satellite | • | • | • |
| CareTrack 3 yr. subscription | • | • | • |
| Machine status indication | • | • | • |
| Engine speed sensing power control | • | • | • |
| Automatic idling system | • | • | • |
| One-touch power boost | • | • | • |
| Safety stop/start function | • | • | • |
| Adjustable LCD color monitor | • | • | • |
| Master electrical disconnect switch | • | • | • |
| Engine restart prevention circuit | • | • | • |
| High-capacity halogen lights: | • | • | • |
| - Frame-mounted 2 | • | • | • |
| - Boom-mounted 2 | • | • | • |
| Batteries, 2 x 12 V / 100 Ah | • | | |
| Batteries, 2 x 12 V / 110 Ah | | • | |
| Batteries, 2 x 12 V / 200 Ah | | | • |
| Start motor, 24 V / 5.5 kW | • | • | • |
| Travel alarm | • | • | • |
| Hydraulic system | | | |
| Automatic sensing hydraulic system | • | • | • |
| - Summation system | • | • | • |
| - Boom priority | • | • | • |
| - Arm priority | • | • | • |
| - Swing priority | • | • | • |
| "ECO" mode fuel saving technology | • | • | • |
| Boom, arm and bucket regeneration valves | • | • | • |
| Swing anti-rebound valves | • | • | • |
| Boom and arm holding valves | • | • | • |
| Multi-stage filtering system | • | • | • |
| Cylinder cushioning | • | • | • |
| Cylinder contamination seals | • | • | • |
| Auxiliary hydraulic valve | • | • | • |
| Automatic two-speed travel motors | • | • | • |
| Hydraulic oil, long life oil 46 | • | • | • |
| Pilot control pattern change | • | • | • |
| Boom float function without HRV | • | • | • |
| Overload warning device | • | • | • |
| Boom cylinders (x2) | | | • |
| Frame | | | |
| Access way with handrail | • | • | • |
| Tool storage area | • | • | • |
| Punched metal anti-slip plates | • | • | • |
| Undercover (heavy-duty) | • | • | • |
| Full height counterweight: | | | |
| - 2 450 kg (5,400 lb) | • | | |
| - 3 200 kg (7,060 lb) | | • | |
| - 4 200 kg (9,260 lb) - Long Crawler (L) | | | • |
| - 5 000 kg (11,030 lb) - Long Reach (LR) | | | • |
| Cab and interior | | | |
| ROPS (ISO12117-2) certified cab | • | • | • |
| Silicon oil and rubber mounts with spring | • | • | • |
| Travel pedals and hand levers | • | • | • |

| | EC140D | EC160D | EC220D |
|---|--------|--------|--------|
| Undercarriage | | | |
| Straight Travel pedal | • | • | • |
| Adjustable operator seat and joystick control console | • | • | • |
| Fabric seat with heater | • | • | • |
| Control joysticks with 4 switches each | • | • | • |
| Heater & air-conditioner, automatic | • | • | • |
| Flexible antenna | • | • | • |
| AM/FM stereo with CD player and MP3 input | • | • | • |
| Hydraulic safety lock lever | • | • | • |
| Cab, all-weather sound suppressed, includes: | • | • | • |
| - Cup holders | • | • | • |
| - Door locks | • | • | • |
| - Tinted glass | • | • | • |
| - Floor mat | • | • | • |
| - Horn | • | • | • |
| - Large storage area | • | • | • |
| - Pull-up type front window | • | • | • |
| - Removable lower windshield | • | • | • |
| - Seat belt | • | • | • |
| - Safety glass | • | • | • |
| - Sun screens, front, roof, rear | • | • | • |
| - Windshield wiper with intermittent feature | • | • | • |
| Opening roof hatch | • | • | • |
| Rear view camera | • | • | • |
| Master key | • | • | • |
| Undercarriage | | | |
| Undercover (heavy-duty) | • | | • |
| Hydraulic track adjusters | • | • | • |
| Greased and sealed track link | • | • | • |
| Track Guard | • | • | • |
| Track shoes | | | |
| 600 mm (24") with triple grousers | • | • | |
| 800 mm (32") with triple grousers | | | • |
| Digging equipment | | | |
| Boom: 4,6 m (15' 1") monoblock | • | | |
| Boom: 5,2 m (17' 1") monoblock | | • | |
| Boom: 5,7 m (18' 8") monoblock | | | • |
| Boom: 8,85 m (29' 0") monoblock, Long Reach | | | • |
| Arm: 2,5 m (8' 2") | • | | |
| Arm: 2,6 m (8' 6") | | • | |
| Arm: 2,9 m (9' 6") | | | • |
| Arm: 6,25 m (20' 6"), Long Reach | | | • |
| Linkage without lifting eye | • | • | |
| Manual centralized lubrication | • | • | • |
| Linkage without lifting eye | | | • |

OPTIONAL EQUIPMENT

| | EC140D | EC160D | EC220D |
|--|--------|--------|--------|
| Engine | | | |
| Block heater: 120 V | • | • | • |
| Oil bath pre-cleaner | | | • |
| Diesel coolant heater, 5 kW | • | • | • |
| Water separator with heater | • | • | • |
| Auto engine shutdown | • | • | • |
| Standard cooling system by fan clutch (40 deg. C) | • | • | • |
| Fuel filler pump: 35 l/min (9 gpm) | • | • | |
| Fuel filler pump: 50 l/min (13.2 gpm), with automatic shut-off | | | • |
| Electric | | | |
| Extra lights: | • | • | • |
| - Cab-mounted 3 | • | • | • |
| - Counterweight-mounted 1 | • | • | • |
| Anti-theft system | • | • | • |
| Rotating warning beacon | • | • | • |
| Hydraulic system | | | |
| Hose rupture valve: boom | • | • | • |
| Hose rupture valve: arm | • | • | • |
| Overload warning device | | | • |

OPTIONAL EQUIPMENT

| | EC140D | EC160D | EC220D |
|---|--------|--------|--------|
| Boom float function with HRV | • | • | • |
| Hydraulic piping: | • | • | • |
| - Work tool management system (up to 18 programmable memories) | • | • | • |
| - Hammer & shear, 1 and 2 pump flow | • | • | • |
| - Hammer & shear: variable flow and pressure pre-setting | • | • | • |
| - Additional return filter | • | • | • |
| - Slope & rotator | • | • | • |
| - Grapple | • | • | • |
| - Oil leak (drain) line | • | • | • |
| - Quick coupler piping | • | • | • |
| Volvo hydraulic quick coupler S1 | | • | • |
| Volvo hydraulic quick coupler S6 | • | • | |
| Volvo hydraulic quick coupler U14 | • | | |
| Volvo hydraulic quick coupler U16 | | • | |
| Volvo hydraulic quick coupler U21 | | | • |
| Hydraulic oil, biodegradable 46 | • | • | • |
| Hydraulic oil, long life oil 32 | • | • | • |
| Hydraulic oil, long life oil 68 | • | • | • |
| Frame | | | |
| Full height counterweight: | | | |
| - 2 100 kg (4,630 lb) | • | | |
| Cab and interior | | | |
| Fabric seat without heater | • | • | • |
| Fabric seat with heater and air suspension | • | • | • |
| Control joysticks with semi-long | | | • |
| Control joysticks with 3 switch & 1 proportional | | | • |
| Rain shield | • | • | • |
| Falling object guard (FOG) | • | • | • |
| - Frame-mounted | | | • |
| - Cab-mounted | • | • | • |
| Cab-mounted falling object protective structure (FOPS) | • | • | • |
| Smoker kit (ashtray and lighter) | • | • | • |
| Safety net for front window | • | • | • |
| Lower wiper with intermittent control | • | • | • |
| Anti-vandalism kit | • | • | • |
| Undercarriage | | | |
| Full track guard | • | | • |
| Undercover (heavy-duty) | | • | |
| Dozer blade | • | | |
| Track shoes | | | |
| 500/600/600HD/700HD/750 mm (20"/24"/24"/28"/30") with triple grousers | • | | |
| 500 mm (20") with rubber grouser | • | | |
| 500/600/700/800/900 mm (20"/24"/28"/32"/36") with triple grousers | | • | |
| 500/600/600HD/700/900 mm (20"/24"/24"/28"/36") with triple grousers | | | • |
| Track shoes 700 mm (28") with double grousers | | | • |
| Digging equipment | | | |
| Boom: 4,6 m (15' 11") 2 piece boom | • | | |
| Boom: 5,7 m (18' 8") monoblock, heavy-duty | | | • |
| Boom: 5,57 m (18' 3") 2 piece boom | | | • |
| Arm: 2,1 m (6' 11"), 3,0 m (9' 10") | • | | |
| Arm: 2,3 m (7' 7"), 3,0 m (9' 10") | | • | |
| Arm: 2,9 m (9' 6"), 2,5 m (8' 2"), 3,5 m (11' 6") | | | • |
| Linkage with lifting eye | • | • | • |
| Service | | | |
| Tool kit, daily maintenance | • | • | • |
| Tool kit, full scale | • | • | • |

SELECTION OF VOLVO OPTIONAL EQUIPMENT

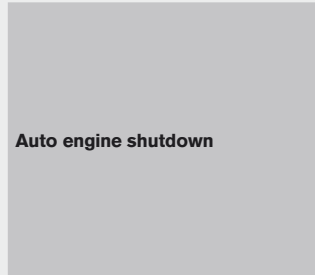

Auto engine shutdown

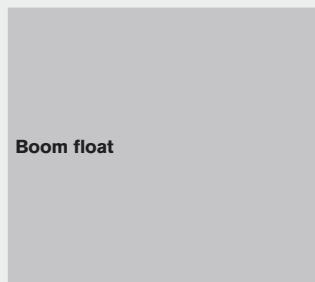

Boom float

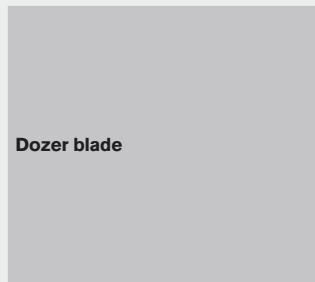

Dozer blade



X3

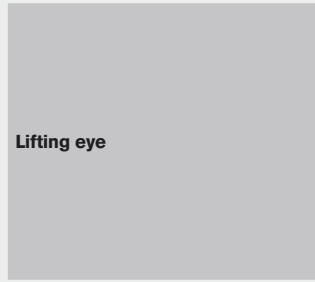

Lifting eye

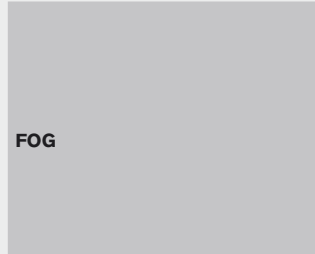

FOG



VOLVO CONSTRUCTION EQUIPMENT



Volvo Construction Equipment is different. Our machines are designed, built and supported in a different way. That difference comes from an engineering heritage of over 175 years. A heritage of thinking first about the people who actually use the machines. About how to help them be safer, more comfortable, more productive. About the environment we all share. The result of that thinking is a growing range of machines and a global support network dedicated to helping you do more. People around the world are proud to use Volvo.

Not all products are available in all markets. Under our policy of continuous improvement, we reserve the right to change specifications and design without prior notice. The illustrations do not necessarily show the standard version of the machine.

VOLVO

Volvo Construction Equipment
www.volvoce.com/na

Ref. No. VOE2210009254
Printed in USA 03/12 - 0,0
Volvo, Asheville
Copyright © 2012 Volvo

English
USA

Courtesy of Machine.Market