



sarens
group

www.sarens.com

LIEBHERR LTM 1400

400 TON

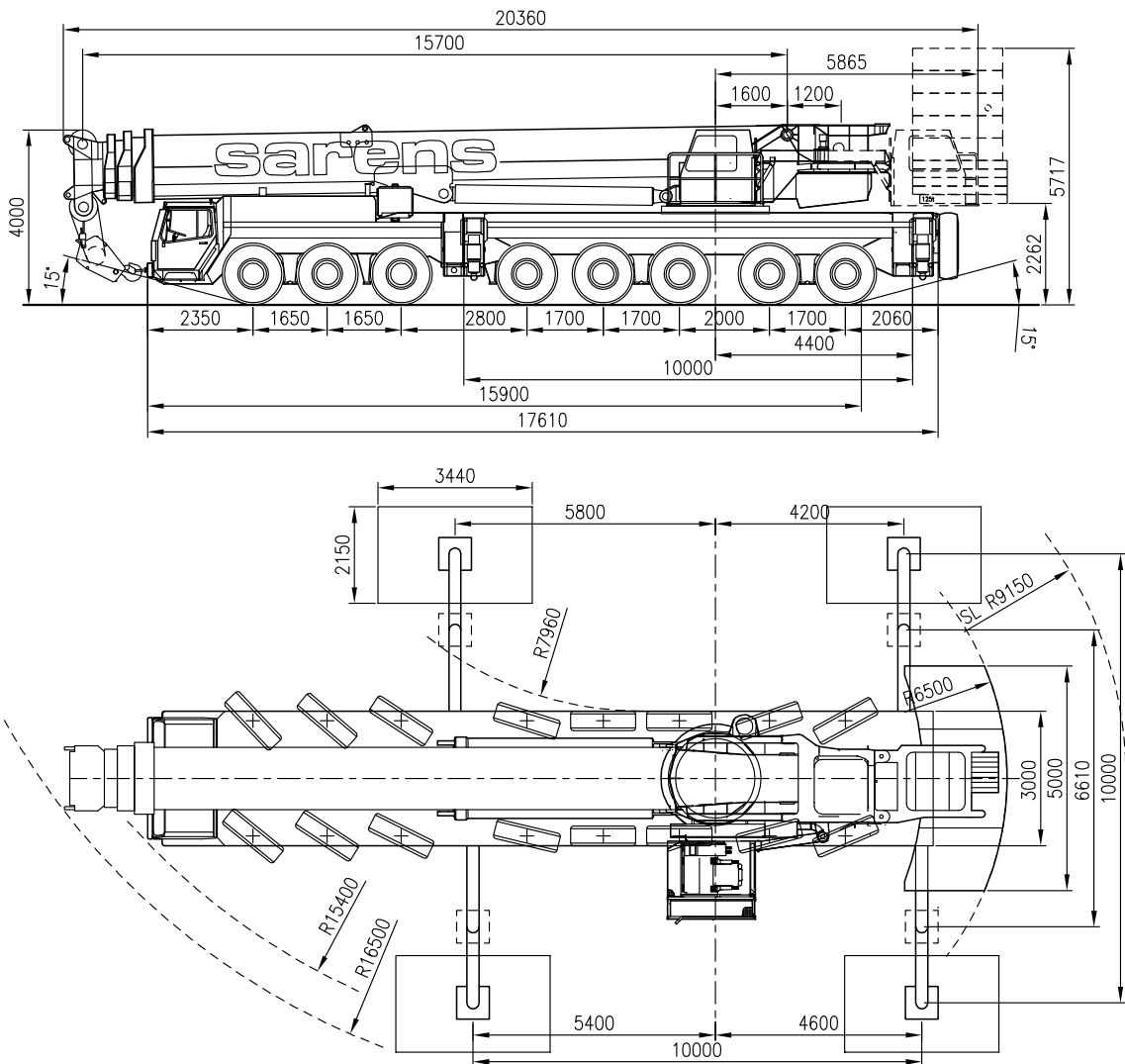

Axle load / Charge par essieu / Achslast / Aslast	: 8 x 12 t	(☐ 0 t)
Total weight / Poids total / Gesamtgewicht / Totaal gewicht	: 96 t	(☐ 0 t)
Tyres / Pneus / Bereifung / Banden	: 14.00 R 25	
Counterweight-carrier / Chariot de contrepoids / Ballastwagen / Ballastwagen	: 50 t	

nothing too heavy, nothing too high





LIEBHERR LTM 1400

Working ranges
Portées

400 TON

Arbeitsbereiche
Werkbereich

T + TA

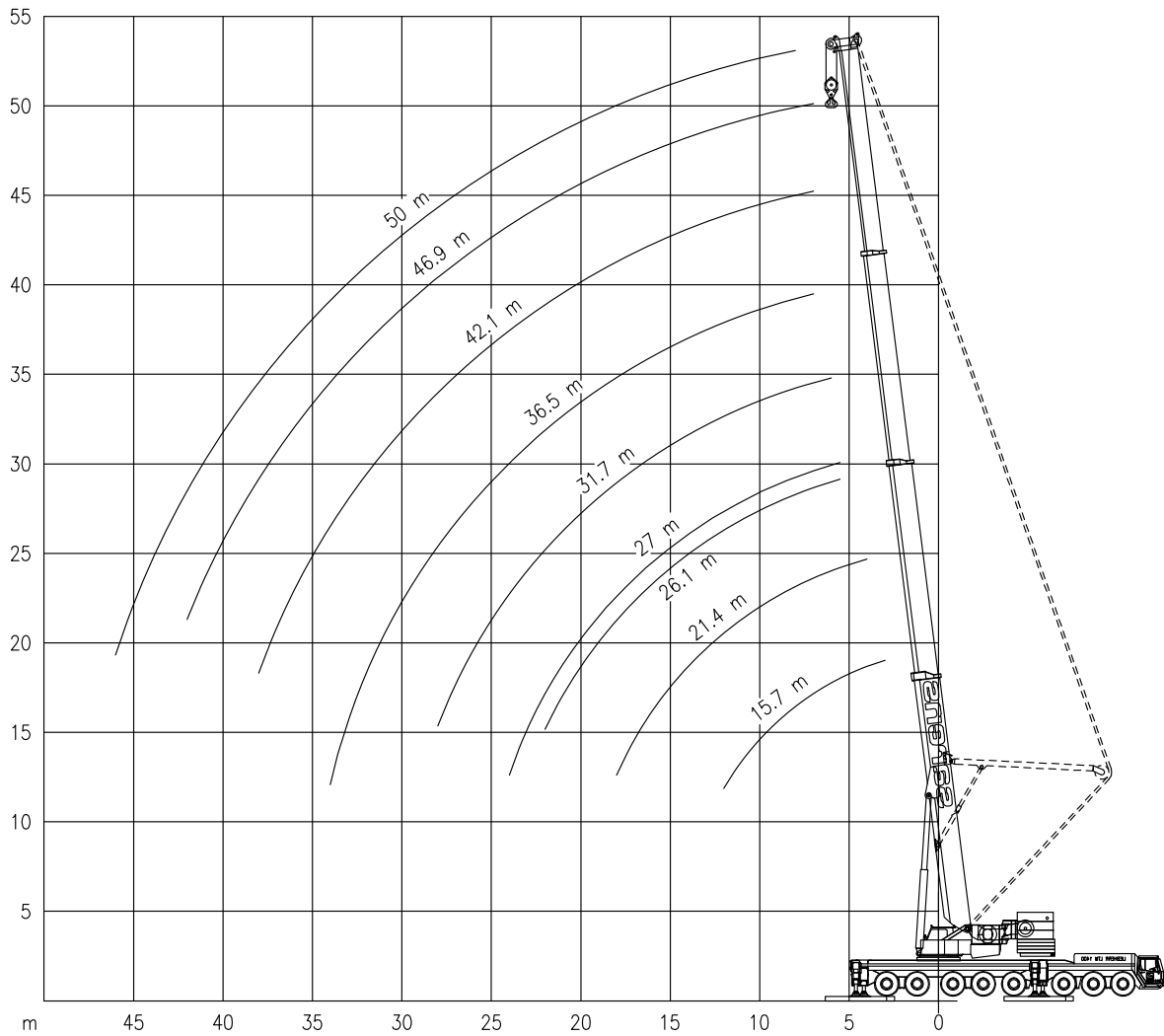



LIEBHERR LTM 1400

400 TON

Lifting capacities
Capacités

Tragfähigkeiten
Capaciteiten

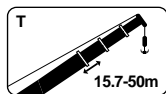

T

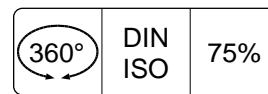
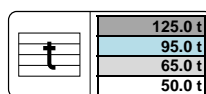

	15.7 m*	15.7 m	21.4 m	26.1 m	27.0 m	31.7 m	36.5 m	42.1 m	46.9 m	50.0 m
m	t	t	t	t	t	t	t	t	t	t
3.0	400.0**	350.0**	-	-	-	-	-	-	-	-
3.5	340.0**	310.0**	-	-	-	-	-	-	-	-
4.0	300.0**	280.0**	-	-	-	-	-	-	-	-
4.5	280.0**	260.0**	250.0**	-	-	-	-	-	-	-
5.0	260.0**	246.0	235.0	-	160.0	-	-	-	-	-
5.5	240.0	229.0	221.0	192.0	152.0	-	-	-	-	-
6.0	228.0	214.0	209.0	181.0	145.0	155.0	-	-	-	-
7.0	203.0	190.0	186.0	163.0	132.0	140.0	123.0	106.0	92.0	-
8.0	181.0	169.0	166.0	148.0	122.0	127.0	113.0	99.0	86.0	80.0
9.0	163.0	153.0	150.0	135.0	113.0	116.0	104.0	93.0	81.0	76.0
10.0	148.0	139.0	136.0	124.0	105.0	107.0	96.0	87.0	76.0	72.0
12.0	125.0	118.0	115.0	107.0	92.0	92.0	83.0	77.0	68.0	64.0
14.0	-	-	99.0	93.0	81.0	80.0	72.0	67.0	61.0	57.0
16.0	-	-	86.0	81.0	73.0	71.0	64.0	59.0	55.0	50.0
18.0	-	-	74.0	72.0	66.0	63.0	57.0	53.0	49.5	45.0
20.0	-	-	-	65.0	60.0	57.0	52.0	48.0	45.0	41.0
22.0	-	-	-	57.0	55.0	51.0	46.5	43.5	41.0	37.0
24.0	-	-	-	-	50.0	46.5	42.5	40.0	37.5	34.0
26.0	-	-	-	-	-	43.0	39.0	36.5	34.5	31.0
28.0	-	-	-	-	-	39.5	35.5	33.5	32.0	28.6
30.0	-	-	-	-	-	-	33.0	31.0	29.5	26.4
32.0	-	-	-	-	-	-	30.5	29.0	27.3	24.5
34.0	-	-	-	-	-	-	27.0	27.0	25.4	22.7
36.0	-	-	-	-	-	-	-	25.0	23.6	21.1
38.0	-	-	-	-	-	-	-	23.1	22.0	19.7
40.0	-	-	-	-	-	-	-	-	20.4	18.5
42.0	-	-	-	-	-	-	-	-	18.9	17.3
44.0	-	-	-	-	-	-	-	-	-	16.1
46.0	-	-	-	-	-	-	-	-	-	15.1

	15.7 m*	15.7 m	21.4 m	26.1 m	27.0 m	31.7 m	36.5 m	42.1 m	46.9 m	50.0 m
m	t	t	t	t	t	t	t	t	t	t
3.0	400.0**	350.0**	-	-	-	-	-	-	-	-
3.5	340.0**	310.0**	-	-	-	-	-	-	-	-
4.0	300.0**	280.0**	-	-	-	-	-	-	-	-
4.5	275.0**	252.0**	245.0	-	-	-	-	-	-	-
5.0	250.0**	234.0	229.0	-	160.0	-	-	-	-	-
5.5	233.0	217.0	214.0	192.0	152.0	-	-	-	-	-
6.0	218.0	203.0	200.0	181.0	145.0	155.0	-	-	-	-
7.0	192.0	180.0	176.0	163.0	132.0	140.0	123.0	106.0	92.0	-
8.0	171.0	160.0	157.0	148.0	122.0	127.0	113.0	99.0	86.0	80.0
9.0	154.0	145.0	142.0	135.0	113.0	116.0	104.0	93.0	81.0	76.0
10.0	139.0	131.0	128.0	123.0	105.0	107.0	96.0	87.0	76.0	72.0
12.0	114.0	108.0	105.0	104.0	92.0	92.0	83.0	77.0	68.0	64.0
14.0	-	-	89.0	88.0	81.0	80.0	72.0	67.0	61.0	57.0
16.0	-	-	75.0	74.0	73.0	71.0	64.0	59.0	55.0	50.0
18.0	-	-	63.0	62.0	66.0	63.0	57.0	53.0	49.5	45.0
20.0	-	-	-	52.0	59.0	54.0	52.0	48.0	45.0	41.0
22.0	-	-	-	45.0	51.0	46.0	46.5	43.5	41.0	37.0
24.0	-	-	-	-	44.5	39.5	40.0	40.0	37.5	34.0
26.0	-	-	-	-	-	34.0	36.0	36.5	34.5	31.0
28.0	-	-	-	-	-	30.0	33.5	32.0	32.0	28.6
30.0	-	-	-	-	-	-	31.0	28.7	29.4	26.4
32.0	-	-	-	-	-	-	28.7	25.5	26.3	24.5
34.0	-	-	-	-	-	-	26.1	22.9	23.5	22.7
36.0	-	-	-	-	-	-	-	20.6	21.2	21.1
38.0	-	-	-	-	-	-	-	18.5	19.2	19.3
40.0	-	-	-	-	-	-	-	-	17.3	17.4
42.0	-	-	-	-	-	-	-	-	15.6	15.7
44.0	-	-	-	-	-	-	-	-	-	14.2
46.0	-	-	-	-	-	-	-	-	-	12.9

*Over rear / En arrière / Nach hinten / Over achterzijde.

**Only with special equipment / Seulement avec équipement spécial / Nur mit Zusatzinrichtung / Enkel met speciale uitrusting.



LIEBHERR LTM 1400

400 TON

Lifting capacities
Capacités

Tragfähigkeiten
Capaciteiten

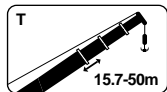

T

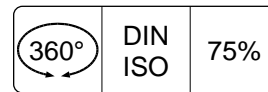
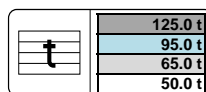

	15.7 m	21.4 m	26.1 m	27.0 m	31.7 m	36.5 m	42.1 m	46.9 m	50.0 m
m	t	t	t	t	t	t	t	t	t
3.0	310.0**	-	-	-	-	-	-	-	-
3.5	283.0**	-	-	-	-	-	-	-	-
4.0	259.0**	-	-	-	-	-	-	-	-
4.5	239.0	235.0	-	-	-	-	-	-	-
5.0	221.0	217.0	-	-	-	-	-	-	-
5.5	206.0	202.0	192.0	152.0	-	-	-	-	-
6.0	192.0	189.0	181.0	145.0	155.0	-	-	-	-
7.0	170.0	167.0	163.0	132.0	140.0	123.0	106.0	92.0	-
8.0	150.0	148.0	148.0	122.0	127.0	113.0	99.0	86.0	80.0
9.0	134.0	132.0	131.0	113.0	116.0	104.0	93.0	81.0	76.0
10.0	120.0	117.0	116.0	105.0	107.0	96.0	87.0	76.0	72.0
12.0	98.0	95.0	94.0	92.0	91.0	83.0	77.0	68.0	64.0
14.0	-	74.0	73.0	79.0	71.0	69.0	67.0	61.0	57.0
16.0	-	58.0	57.0	64.0	58.0	56.0	56.0	55.0	50.0
18.0	-	46.5	45.5	52.0	47.0	51.0	47.0	46.5	45.0
20.0	-	-	37.0	43.0	38.0	44.5	40.0	40.0	39.5
22.0	-	-	30.5	36.5	31.5	37.5	34.5	34.5	34.0
24.0	-	-	-	31.5	26.7	32.5	29.3	29.9	29.7
26.0	-	-	-	-	22.6	28.3	25.2	26.0	26.0
28.0	-	-	-	-	19.1	24.9	21.7	22.5	22.7
30.0	-	-	-	-	-	22.0	18.8	19.6	19.8
32.0	-	-	-	-	-	19.7	16.3	17.1	17.3
34.0	-	-	-	-	-	17.7	14.1	14.9	15.0
36.0	-	-	-	-	-	-	12.2	13.0	13.1
38.0	-	-	-	-	-	-	10.6	11.3	11.4
40.0	-	-	-	-	-	-	-	9.9	10.0
42.0	-	-	-	-	-	-	-	8.6	8.7
44.0	-	-	-	-	-	-	-	-	7.5
46.0	-	-	-	-	-	-	-	-	6.6

	15.7 m	21.4 m	26.1 m	27.0 m	31.7 m	36.5 m	42.1 m	46.9 m	50.0 m
m	t	t	t	t	t	t	t	t	t
3.0	300.0**	-	-	-	-	-	-	-	-
3.5	274.0**	-	-	-	-	-	-	-	-
4.0	250.0**	-	-	-	-	-	-	-	-
4.5	230.0	225.0	-	-	-	-	-	-	-
5.0	213.0	209.0	-	-	-	-	-	-	-
5.5	198.0	194.0	192.0	152.0	-	-	-	-	-
6.0	185.0	181.0	181.0	145.0	155.0	-	-	-	-
7.0	163.0	159.0	158.0	132.0	140.0	123.0	106.0	92.0	-
8.0	142.0	139.0	138.0	122.0	127.0	113.0	99.0	86.0	80.0
9.0	126.0	123.0	122.0	113.0	116.0	104.0	93.0	81.0	76.0
10.0	112.0	109.0	105.0	105.0	100.0	95.0	87.0	76.0	72.0
12.0	86.0	84.0	79.0	87.0	75.0	73.0	71.0	68.0	64.0
14.0	-	63.0	61.0	69.0	59.0	63.0	57.0	55.0	54.0
16.0	-	48.0	47.0	54.0	47.0	53.0	46.0	45.5	45.0
18.0	-	38.0	37.0	43.5	38.0	44.5	38.5	38.1	37.5
20.0	-	-	29.7	36.0	31.0	37.0	32.5	32.2	32.0
22.0	-	-	24.3	30.0	25.4	31.5	27.5	27.6	27.4
24.0	-	-	-	25.9	21.0	26.9	23.6	23.7	23.6
26.0	-	-	-	-	17.3	23.3	20.1	20.6	20.5
28.0	-	-	-	-	14.4	20.3	17.1	17.9	17.8
30.0	-	-	-	-	-	17.9	14.5	15.3	15.5
32.0	-	-	-	-	-	15.9	12.3	13.1	13.3
34.0	-	-	-	-	-	14.1	10.5	11.2	11.4
36.0	-	-	-	-	-	-	8.9	9.6	9.8
38.0	-	-	-	-	-	-	7.6	8.2	8.4
40.0	-	-	-	-	-	-	-	7.0	7.1
42.0	-	-	-	-	-	-	-	5.9	6.0
44.0	-	-	-	-	-	-	-	-	5.1
46.0	-	-	-	-	-	-	-	-	4.2

**Only with special equipment / Seulement avec équipement spécial / Nur mit Zusatzeinrichtung / Enkel met speciale uitrusting.



LIEBHERR LTM 1400

400 TON

Lifting capacities
Capacités

Tragfähigkeiten
Capacités

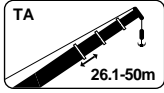

TA

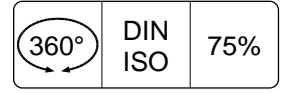
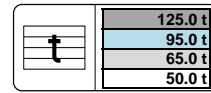

	26.1 m	27.0 m	31.7 m	36.5 m	42.1 m	46.9 m	50.0 m
	m	t	t	t	t	t	t
5.5	200.0	145.0	-	-	-	-	-
6.0	193.0	145.0	160.0	-	-	-	-
7.0	180.0	145.0	153.0	123.0	105.0	88.0	-
8.0	163.0	140.0	146.0	120.0	103.0	86.0	77.0
9.0	150.0	135.0	138.0	115.0	100.0	84.0	76.0
10.0	136.0	126.0	128.0	110.0	98.0	82.0	74.0
12.0	114.0	112.0	110.0	97.0	88.0	76.0	70.0
14.0	97.0	99.0	96.0	87.0	79.0	70.0	65.0
16.0	85.0	89.0	85.0	79.0	72.0	64.0	60.0
18.0	73.0	79.0	74.0	71.0	65.0	58.0	56.0
20.0	65.0	70.0	65.0	64.0	59.0	54.0	51.0
22.0	57.0	62.0	58.0	58.0	54.0	49.5	47.0
24.0	-	51.0	51.0	52.0	49.5	46.0	43.5
26.0	-	-	45.0	46.0	45.5	42.5	40.0
28.0	-	-	39.5	42.5	42.0	39.5	37.0
30.0	-	-	-	40.0	38.0	37.0	34.0
32.0	-	-	-	37.5	34.5	34.5	32.0
34.0	-	-	-	29.0	31.0	32.0	29.8
36.0	-	-	-	-	28.7	29.4	28.0
38.0	-	-	-	-	26.0	26.9	26.2
40.0	-	-	-	-	-	24.8	24.8
42.0	-	-	-	-	-	22.8	22.9
44.0	-	-	-	-	-	-	21.1
46.0	-	-	-	-	-	-	17.5

	26.1 m	27.0 m	31.7 m	36.5 m	42.1 m	46.9 m	50.0 m
	m	t	t	t	t	t	t
5.5	200.0	145.0	-	-	-	-	-
6.0	193.0	145.0	160.0	-	-	-	-
7.0	177.0	145.0	153.0	123.0	105.0	88.0	-
8.0	158.0	140.0	146.0	120.0	103.0	86.0	77.0
9.0	142.0	135.0	138.0	115.0	100.0	84.0	76.0
10.0	129.0	126.0	128.0	110.0	98.0	82.0	74.0
12.0	107.0	112.0	108.0	97.0	88.0	76.0	70.0
14.0	90.0	95.0	91.0	87.0	79.0	70.0	65.0
16.0	77.0	82.0	78.0	78.0	72.0	64.0	60.0
18.0	63.0	69.0	65.0	66.0	65.0	58.0	56.0
20.0	53.0	59.0	54.0	59.0	57.0	54.0	51.0
22.0	45.5	51.0	46.5	52.0	49.5	49.5	47.0
24.0	-	44.5	40.0	46.0	43.0	44.0	43.5
26.0	-	-	35.0	41.0	37.5	38.5	38.5
28.0	-	-	31.0	65.5	33.5	34.0	34.5
30.0	-	-	-	32.5	29.9	30.5	30.5
32.0	-	-	-	29.7	26.6	27.5	27.6
34.0	-	-	-	26.9	23.8	24.7	24.8
36.0	-	-	-	-	21.4	22.2	22.3
38.0	-	-	-	-	19.3	20.1	20.2
40.0	-	-	-	-	-	18.2	18.3
42.0	-	-	-	-	-	16.4	16.5
44.0	-	-	-	-	-	-	14.9
46.0	-	-	-	-	-	-	13.5



LIEBHERR LTM 1400

Working ranges
Portées

400 TON

Arbeitsbereiche
Werkbereich

TF

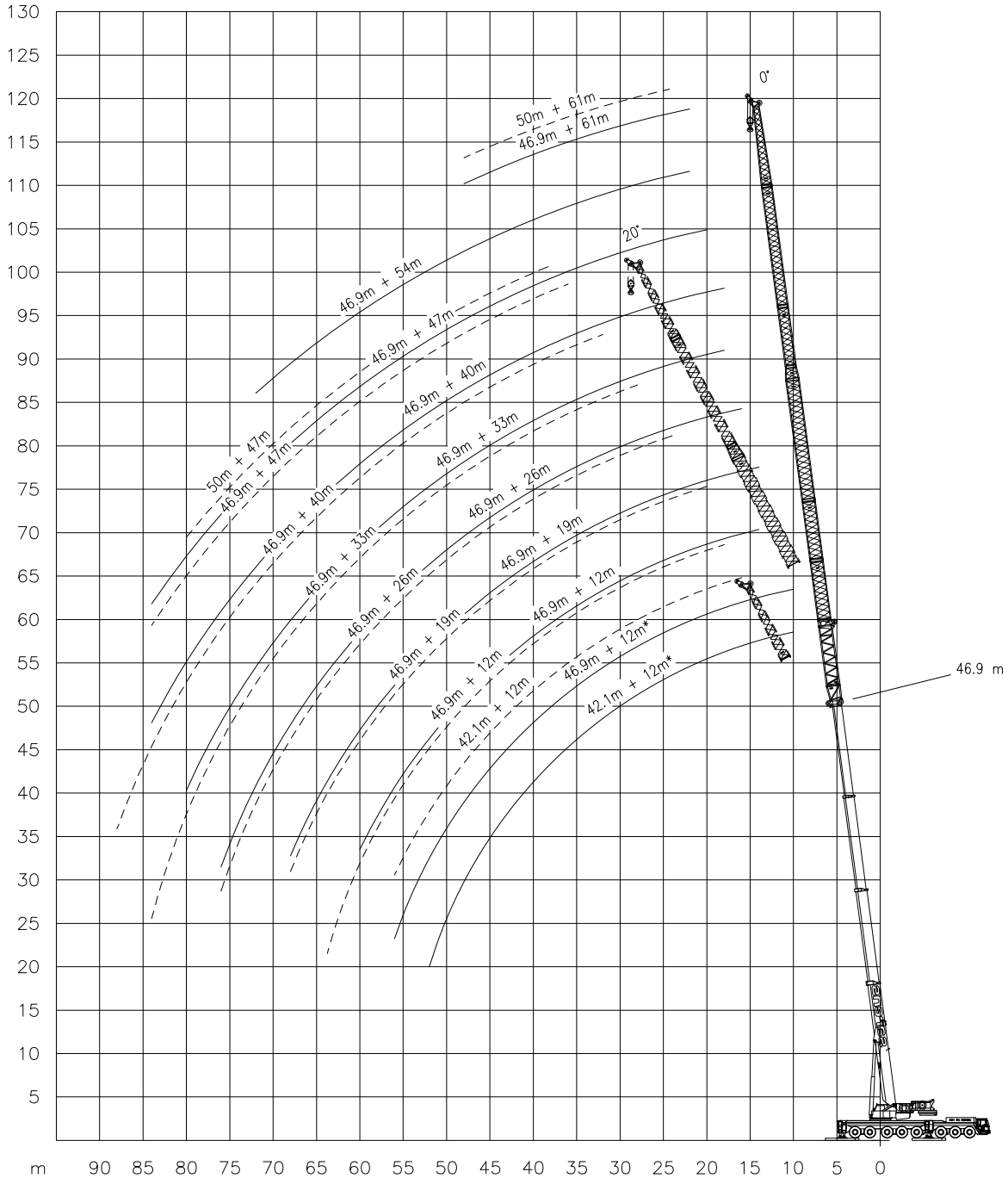

With 8.9 m main boom extension / Avec rallonge de flèche principale de 8.9 m / Mit 8.9 m Hauptauslegerverlängerung / Met 8.9 m hoofdgiekverlenging

* : With 1.9 m main boom extension / Avec rallonge de flèche principale de 1.9 m / Mit 1.9 m Hauptauslegerverlängerung / Met 1.9 m hoofdgiekverlenging



LIEBHERR LTM 1400

400 TON

Lifting capacities
Capacités

Tragfähigkeiten
Capacités

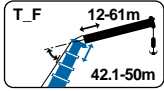

TF

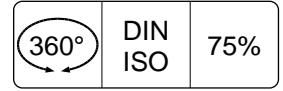
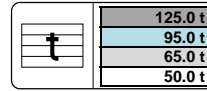

		42.1 m + 8.9 m															
		12 m*		12 m		19 m		26 m		33 m		40 m		47 m		54 m	61 m
		0°	0°	20°	0°	20°	0°	20°	0°	20°	0°	20°	0°	20°	0°	0°	0°
m	t	t	t	t	t	t	t	t	t	t	t	t	t	t	t	t	t
10.0	45.0	-	-	-	-	-	-	-	-	-	-	-	-	-	-	-	-
12.0	42.0	-	-	-	-	-	-	-	-	-	-	-	-	-	-	-	-
14.0	39.5	-	-	-	-	-	-	-	-	-	-	-	-	-	-	-	-
16.0	37.0	-	26.0	-	-	-	-	-	-	-	-	-	-	-	-	-	-
18.0	34.5	-	25.0	-	-	-	-	-	-	-	-	-	-	-	-	-	-
20.0	32.5	-	24.0	-	-	-	-	-	-	-	-	-	-	-	-	-	-
22.0	30.5	-	23.1	-	-	-	-	-	-	-	-	-	-	-	-	-	-
24.0	28.9	-	22.2	-	-	-	-	-	-	-	-	-	-	-	-	-	-
26.0	27.5	-	21.2	-	-	-	-	-	-	-	-	-	-	-	-	-	-
28.0	26.2	-	20.2	-	-	-	-	-	-	-	-	-	-	-	-	-	-
30.0	25.0	-	19.2	-	-	-	-	-	-	-	-	-	-	-	-	-	-
32.0	23.7	-	18.4	-	-	-	-	-	-	-	-	-	-	-	-	-	-
34.0	22.4	-	17.6	-	-	-	-	-	-	-	-	-	-	-	-	-	-
36.0	21.0	-	16.9	-	-	-	-	-	-	-	-	-	-	-	-	-	-
38.0	19.5	-	16.2	-	-	-	-	-	-	-	-	-	-	-	-	-	-
40.0	17.8	-	15.5	-	-	-	-	-	-	-	-	-	-	-	-	-	-
44.0	14.5	-	14.3	-	-	-	-	-	-	-	-	-	-	-	-	-	-
48.0	11.8	-	12.8	-	-	-	-	-	-	-	-	-	-	-	-	-	-
52.0	9.6	-	10.4	-	-	-	-	-	-	-	-	-	-	-	-	-	-
56.0	-	-	8.4	-	-	-	-	-	-	-	-	-	-	-	-	-	-
		46.9 m + 8.9 m															
10.0	42.0	-	-	-	-	-	-	-	-	-	-	-	-	-	-	-	-
12.0	40.0	36.0	-	-	-	-	-	-	-	-	-	-	-	-	-	-	-
14.0	38.0	34.0	-	27.2	-	-	-	-	-	-	-	-	-	-	-	-	-
16.0	36.0	32.0	-	25.6	-	20.0	-	-	-	-	-	-	-	-	-	-	-
18.0	34.0	29.8	24.0	24.1	-	18.8	-	14.9	-	12.0	-	-	-	-	-	-	-
20.0	32.0	27.9	23.1	22.7	17.0	17.8	-	14.0	-	11.3	-	9.2	-	-	-	-	-
22.0	30.0	26.1	22.2	21.4	16.3	16.8	-	13.2	-	10.7	-	8.6	-	6.5	4.7	-	-
24.0	28.5	24.5	21.3	20.1	15.7	16.0	11.5	12.4	-	10.0	-	8.0	-	6.0	4.3	-	-
26.0	27.0	23.0	20.5	19.0	15.1	15.2	11.1	11.7	-	9.4	-	7.5	-	5.6	4.0	-	-
28.0	25.3	21.7	19.6	17.9	14.6	14.4	10.7	11.1	8.0	8.9	-	7.0	-	5.2	3.7	-	-
30.0	23.8	20.5	18.6	16.9	14.1	13.6	10.3	10.5	7.6	8.4	-	6.6	-	4.8	3.4	-	-
32.0	22.2	19.4	17.7	16.0	13.5	12.8	9.9	9.9	7.3	8.0	5.0	6.2	-	4.5	3.2	-	-
34.0	20.8	18.4	16.8	15.1	12.9	12.2	9.6	9.4	7.0	7.5	4.9	5.8	-	4.2	3.0	-	-
36.0	19.4	17.4	16.1	14.3	12.4	11.6	9.3	9.0	6.7	7.1	4.7	5.4	3.5	3.9	2.8	-	-
38.0	18.1	16.2	15.4	13.6	11.9	11.0	9.0	8.6	6.4	6.7	4.5	5.1	3.4	3.7	2.6	-	-
40.0	17.0	15.2	14.7	12.9	11.5	10.5	8.7	8.2	6.1	6.4	4.3	4.8	3.2	3.5	2.4	-	-
44.0	14.6	13.4	13.5	11.8	10.6	9.6	8.2	7.5	5.7	5.8	3.9	4.3	3.0	3.1	2.1	-	-
48.0	11.9	11.9	12.0	10.8	9.8	8.8	7.7	6.8	5.3	5.2	3.7	3.9	2.7	2.8	1.9	-	-
52.0	9.7	10.0	10.6	9.5	9.1	8.0	7.1	6.2	4.9	4.8	3.4	3.5	2.5	2.5	-	-	-
56.0	7.9	8.1	8.6	8.4	8.5	7.4	6.6	5.6	4.6	4.4	3.2	3.2	2.3	2.2	-	-	-
60.0	-	6.5	6.9	6.9	7.7	6.8	6.2	5.1	4.4	4.1	3.0	2.9	2.1	2.0	-	-	-
64.0	-	-	5.4	5.5	6.2	5.9	5.8	4.7	4.2	3.8	2.8	2.6	1.9	1.8	-	-	-
68.0	-	-	-	4.3	4.8	4.8	5.4	4.3	3.9	3.5	2.7	2.4	1.7	1.6	-	-	-
72.0	-	-	-	-	-	3.7	4.4	3.8	3.6	3.2	2.6	2.2	1.6	1.4	-	-	-
76.0	-	-	-	-	-	2.8	3.3	2.9	3.4	2.9	2.5	2.0	1.5	-	-	-	-
80.0	-	-	-	-	-	-	-	2.1	2.8	2.5	2.3	1.8	1.4	-	-	-	-
84.0	-	-	-	-	-	-	-	-	1.8	1.8	2.2	1.6	1.3	-	-	-	-
88.0	-	-	-	-	-	-	-	-	-	1.6	-	-	-	-	-	-	-
		50.0 m + 8.9 m															
24.0	-	-	-	-	-	-	-	-	-	-	-	-	-	-	-	-	4.1
26.0	-	-	-	-	-	-	-	-	-	-	-	-	-	-	-	-	3.8
28.0	-	-	-	-	-	-	-	-	-	-	-	-	-	-	-	-	3.5
30.0	-	-	-	-	-	-	-	-	-	-	-	-	-	-	-	-	3.3
32.0	-	-	-	-	-	-	-	-	-	-	-	-	-	-	-	-	3.1
34.0	-	-	-	-	-	-	-	-	-	-	-	-	-	-	-	-	2.9
36.0	-	-	-	-	-	-	-	-	-	-	-	-	-	-	-	-	2.7
38.0	-	-	-	-	-	-	-	-	-	-	-	-	-	3.2	-	-	2.5
40.0	-	-	-	-	-	-	-	-	-	-	-	-	-	3.1	-	-	2.3
44.0	-	-	-	-	-	-	-	-	-	-	-	-	-	2.9	-	-	2.0
48.0	-	-	-	-	-	-	-	-	-	-	-	-	-	2.6	-	-	1.8
52.0	-	-	-	-	-	-	-	-	-	-	-	-	-	2.4	-	-	-
56.0	-	-	-	-	-	-	-	-	-	-	-	-	-	2.2	-	-	-
60.0	-	-	-	-	-	-	-	-	-	-	-	-	-	2.0	-	-	-
64.0	-	-	-	-	-	-	-	-	-	-	-	-	-	1.8	-	-	-
68.0	-	-	-	-	-	-	-	-	-	-	-	-	-	1.6	-	-	-
72.0	-	-	-	-	-	-	-	-	-	-	-	-	-	1.5	-	-	-
76.0	-	-	-	-	-	-	-	-	-	-	-	-	-	1.4	-	-	-
80.0	-	-	-	-	-	-	-	-	-	-	-	-	-	1.3	-	-	-

*with 1.9m main boom extension / Avec rallonge de fleche principale de 1.9m / Mit 1.9m Hauptauslegerverlängerung / Met 1.9m hoofdgiiek verlenging



LIEBHERR LTM 1400

Working ranges
Portées

400 TON

Arbeitsbereiche
Werkbereich

TAF

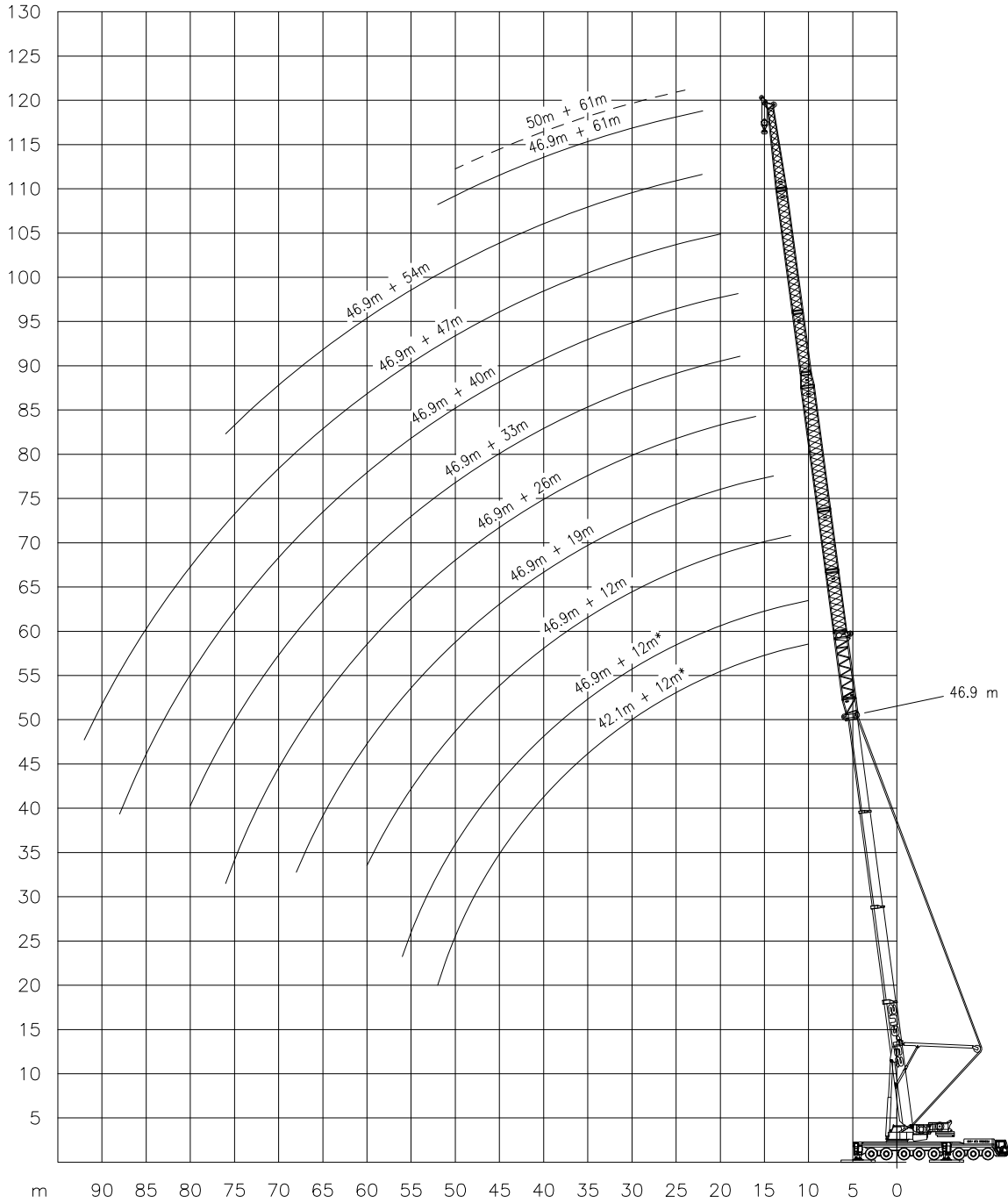

With 8.9 m main boom extension / Avec rallonge de flèche principale de 8.9 m / Mit 8.9 m Hauptauslegerverlängerung / Met 8.9 m hoofdgiekverlenging
* : With 1.9 m main boom extension / Avec rallonge de flèche principale de 1.9 m / Mit 1.9 m Hauptauslegerverlängerung / Met 1.9 m hoofdgiekverlenging



LIEBHERR LTM 1400

400 TON

Lifting capacities
Capacités

Tragfähigkeiten
Capaciteiten

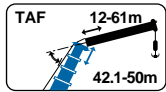

TAF

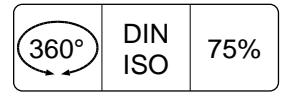
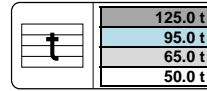

42.1 m + 8.9 m									
	12 m*	12 m	19 m	26 m	33 m	40 m	47 m	54 m	61 m
m	t	t	t	t	t	t	t	t	t
10.0	45.0	-	-	-	-	-	-	-	-
12.0	42.5	-	-	-	-	-	-	-	-
14.0	40.0	-	-	-	-	-	-	-	-
16.0	37.5	-	-	-	-	-	-	-	-
18.0	35.5	-	-	-	-	-	-	-	-
20.0	33.5	-	-	-	-	-	-	-	-
22.0	31.5	-	-	-	-	-	-	-	-
24.0	30.0	-	-	-	-	-	-	-	-
26.0	28.4	-	-	-	-	-	-	-	-
28.0	27.1	-	-	-	-	-	-	-	-
30.0	25.8	-	-	-	-	-	-	-	-
32.0	24.7	-	-	-	-	-	-	-	-
34.0	23.6	-	-	-	-	-	-	-	-
36.0	22.7	-	-	-	-	-	-	-	-
38.0	21.8	-	-	-	-	-	-	-	-
40.0	21.1	-	-	-	-	-	-	-	-
44.0	19.8	-	-	-	-	-	-	-	-
48.0	18.0	-	-	-	-	-	-	-	-
52.0	13.7	-	-	-	-	-	-	-	-
46.9 m + 8.9 m									
10.0	42.0	-	-	-	-	-	-	-	-
12.0	40.5	35.0	-	-	-	-	-	-	-
14.0	39.0	34.0	25.9	-	-	-	-	-	-
16.0	37.0	33.0	25.4	19.8	-	-	-	-	-
18.0	35.0	32.0	24.8	19.0	14.5	11.7	-	-	-
20.0	33.0	30.5	24.1	18.0	14.2	11.5	9.0	-	-
22.0	31.0	28.9	23.1	17.1	13.8	11.3	8.8	6.5	4.5
24.0	29.7	27.4	22.0	16.4	13.1	11.0	8.6	6.4	4.4
26.0	28.2	25.9	20.9	15.7	12.5	10.6	8.3	6.2	4.3
28.0	26.9	24.5	19.9	15.0	11.9	10.0	8.0	6.0	4.2
30.0	25.8	23.2	18.9	14.4	11.3	9.5	7.6	5.7	4.1
32.0	24.7	22.0	18.0	13.8	10.8	9.0	7.1	5.4	4.0
34.0	23.6	21.0	17.2	13.2	10.3	8.5	6.6	5.1	3.8
36.0	22.7	20.0	16.4	12.6	9.8	8.1	6.2	4.8	3.5
38.0	21.8	19.0	15.6	12.0	9.3	7.7	5.8	4.5	3.2
40.0	20.8	18.1	14.9	11.5	8.9	7.3	5.5	4.2	3.0
44.0	19.0	16.6	13.7	10.4	8.1	6.5	4.9	3.7	2.6
48.0	17.3	15.0	12.6	9.5	7.3	5.9	4.3	3.3	2.2
52.0	15.5	13.4	11.6	8.9	6.7	5.3	3.9	2.9	1.9
56.0	12.5	12.2	10.8	8.3	6.2	4.9	3.5	2.6	-
60.0	-	10.9	9.9	7.9	5.8	4.5	3.2	2.3	-
64.0	-	-	9.0	7.5	5.4	4.2	2.9	2.1	-
68.0	-	-	8.2	7.1	5.0	3.9	2.7	1.9	-
72.0	-	-	-	6.7	4.8	3.7	2.5	1.7	-
76.0	-	-	-	5.2	4.6	3.5	2.3	1.5	-
80.0	-	-	-	-	4.4	3.3	2.1	-	-
84.0	-	-	-	-	-	3.2	2.0	-	-
88.0	-	-	-	-	-	3.1	1.8	-	-
92.0	-	-	-	-	-	-	1.7	-	-
50.0 m + 8.9 m									
24.0	-	-	-	-	-	-	-	-	4.1
26.0	-	-	-	-	-	-	-	-	4.0
28.0	-	-	-	-	-	-	-	-	3.9
30.0	-	-	-	-	-	-	-	-	3.8
32.0	-	-	-	-	-	-	-	-	3.6
34.0	-	-	-	-	-	-	-	-	3.4
36.0	-	-	-	-	-	-	-	-	3.1
38.0	-	-	-	-	-	-	-	-	2.9
40.0	-	-	-	-	-	-	-	-	2.7
44.0	-	-	-	-	-	-	-	-	2.3
48.0	-	-	-	-	-	-	-	-	2.0
50.0	-	-	-	-	-	-	-	-	1.8

*with 1.9m main boom extension / Avec rallonge de fleche principale de 1.9m / Mit 1.9m Hauptauslegerverlängerung / Met 1.9m hoofdgiek verlenging



LIEBHERR LTM 1400

Working ranges
Portées

400 TON

Arbeitsbereiche
Werkbereich

TN 84°

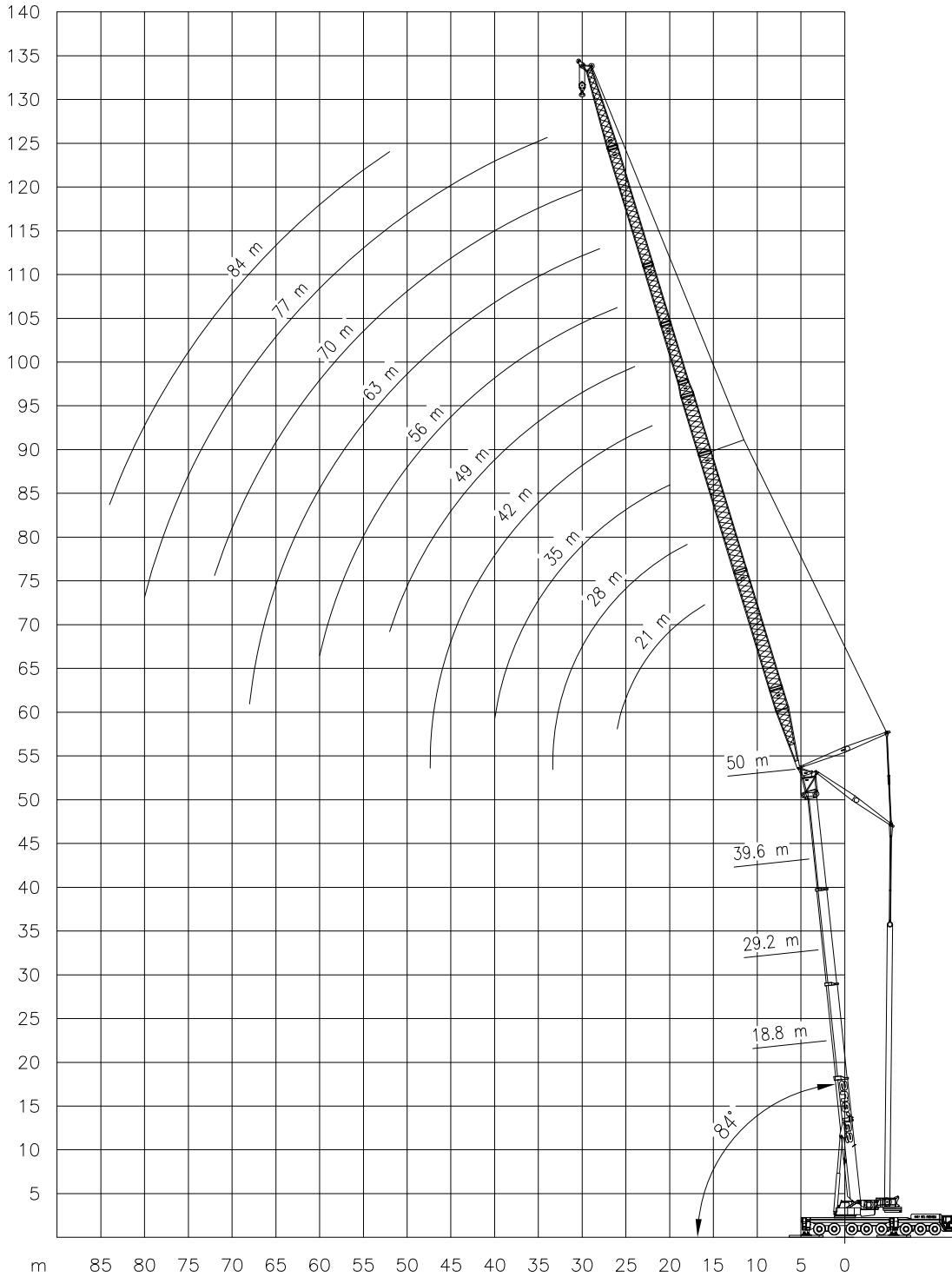



LIEBHERR LTM 1400

400 TON

Lifting capacities
Capacités

Tragfähigkeiten
Capacités

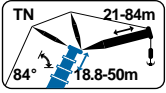

TN 84°

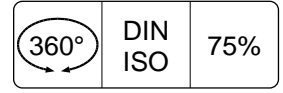
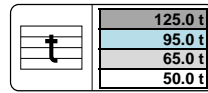

m	18.8 m											29.2 m										
	21m	28m	35m	42m	49m	56m	63m	70m	77m	84m	21m	28m	35m	42m	49m	56m	63m	70m	77m	84m		
	t	t	t	t	t	t	t	t	t	t	t	t	t	t	t	t	t	t	t	t		
9	100	-	-	-	-	-	-	-	-	-	-	-	-	-	-	-	-	-	-	-		
10	96.0	-	-	-	-	-	-	-	-	-	-	-	-	-	-	-	-	-	-	-		
12	92.0	84.0	-	-	-	-	-	-	-	-	84.0	-	-	-	-	-	-	-	-	-		
14	86.0	80.0	64.0	-	-	-	-	-	-	-	81.0	67.0	-	-	-	-	-	-	-	-		
16	82.0	76.0	62.0	51.0	-	-	-	-	-	-	78.0	66.0	53.0	-	-	-	-	-	-	-		
18	79.0	72.0	60.0	49.0	39.0	-	-	-	-	-	76.0	64.0	52.0	41.0	-	-	-	-	-	-		
20	68.0	66.0	58.0	48.0	38.5	32.5	-	-	-	-	70.0	63.0	51.0	40.0	30.0	-	-	-	-	-		
22	58.0	60.0	56.0	47.0	37.5	32.0	26.0	-	-	-	62.0	58.0	50.0	39.5	30.0	24.0	-	-	-	-		
24	-	55.0	52.0	45.0	37.0	31.5	25.5	20.0	-	-	-	53.0	49.0	39.0	29.5	24.0	20.0	-	-	-		
26	-	50.0	47.0	44.0	36.0	31.0	25.5	20.0	16.0	-	-	49.0	47.0	38.0	28.5	24.0	20.0	16.0	-	-		
28	-	46.0	44.0	42.0	34.0	31.0	25.0	20.0	15.7	12.0	-	45.0	44.0	37.5	27.5	24.0	20.0	16.0	12.5	-		
30	-	-	40.0	39.0	32.5	30.5	24.5	19.5	15.4	11.7	-	41.0	40.0	35.0	26.5	24.0	20.0	15.5	12.3	9.0		
32	-	-	37.0	36.0	30.5	29.0	24.5	19.5	15.1	11.5	-	-	37.0	32.5	25.5	23.0	20.0	15.5	12.2	8.8		
34	-	-	34.0	33.0	29.0	27.5	24.0	19.5	14.9	11.3	-	-	34.0	30.5	24.5	22.0	19.5	15.5	11.9	8.6		
36	-	-	-	31.0	27.5	26.0	24.0	19.0	14.6	11.1	-	-	32.0	28.5	23.5	21.5	18.5	15.0	11.7	8.4		
38	-	-	-	29.0	26.0	25.0	22.5	19.0	14.3	10.9	-	-	-	26.5	22.5	20.5	18.0	15.0	11.4	8.2		
40	-	-	-	27.0	24.0	23.0	21.5	19.0	14.0	10.8	-	-	-	25.0	21.5	20.0	17.5	14.5	11.2	8.1		
44	-	-	-	-	21.5	21.0	19.5	18.5	13.4	10.5	-	-	-	-	19.5	18.5	16.5	14.0	10.8	7.8		
48	-	-	-	-	19.0	18.5	18.0	17.0	12.8	10.1	-	-	-	-	18.0	17.0	15.5	13.5	10.4	7.6		
52	-	-	-	-	-	17.0	16.5	16.0	12.2	9.8	-	-	-	-	16.0	14.5	13.0	10.0	7.4	-		
56	-	-	-	-	-	-	15.5	15.0	11.6	9.4	-	-	-	-	14.5	13.5	12.0	9.7	7.2	-		
60	-	-	-	-	-	-	14.5	14.0	11.0	9.0	-	-	-	-	-	13.0	11.5	9.4	7.0	-		
64	-	-	-	-	-	-	-	13.0	10.5	8.6	-	-	-	-	-	-	11.0	9.0	6.8	-		
68	-	-	-	-	-	-	-	12.0	10.0	8.2	-	-	-	-	-	-	10.5	8.6	6.6	-		
72	-	-	-	-	-	-	-	-	9.4	7.8	-	-	-	-	-	-	-	8.3	6.4	-		
76	-	-	-	-	-	-	-	-	-	7.4	-	-	-	-	-	-	-	8.0	6.2	-		
80	-	-	-	-	-	-	-	-	-	7.0	-	-	-	-	-	-	-	-	6.0	-		

m	39.6 m											50.0 m										
	21m	28m	35m	42m	49m	56m	63m	70m	77m	84m	21m	28m	35m	42m	49m	56m	63m	70m	77m	84m		
	t	t	t	t	t	t	t	t	t	t	t	t	t	t	t	t	t	t	t	t		
14	52.0	-	-	-	-	-	-	-	-	-	32.0	-	-	-	-	-	-	-	-	-		
16	51.0	43.0	-	-	-	-	-	-	-	-	32.0	-	-	-	-	-	-	-	-	-		
18	50.0	42.0	35.0	-	-	-	-	-	-	-	32.0	27.0	-	-	-	-	-	-	-	-		
20	48.0	41.5	34.0	28.0	-	-	-	-	-	-	31.0	27.0	22.0	-	-	-	-	-	-	-		
22	47.0	40.5	33.5	27.5	22.0	-	-	-	-	-	31.0	26.5	22.0	17.0	-	-	-	-	-	-		
24	46.0	40.0	33.0	27.0	22.0	17.5	-	-	-	-	30.0	26.0	21.5	17.0	13.5	-	-	-	-	-		
26	-	39.0	32.5	26.5	21.5	17.5	14.0	-	-	-	30.0	26.0	21.5	17.0	13.5	10.0	-	-	-	-		
28	-	38.0	32.0	26.0	21.5	17.5	14.0	11.0	-	-	-	26.0	21.0	16.5	13.0	9.9	8.0	-	-	-		
30	-	37.0	31.0	26.0	21.0	17.0	14.0	11.0	8.5	-	-	25.5	21.0	16.5	13.0	9.8	7.9	6.0	-	-		
32	-	36.0	30.0	25.0	21.0	17.0	14.0	11.0	8.4	6.0	-	25.0	21.0	16.5	13.0	9.8	7.9	6.0	-	-		
34	-	-	29.0	24.5	20.5	17.0	13.5	11.0	8.3	5.9	-	25.0	20.5	16.0	13.0	9.7	7.8	5.9	4.0	-		
36	-	-	28.0	24.0	20.0	16.5	13.5	11.0	8.2	5.8	-	-	20.5	16.0	13.0	9.7	7.8	5.8	4.0	-		
38	-	-	27.0	23.0	19.0	16.0	13.5	11.0	8.2	5.8	-	-	20.0	16.0	12.5	9.6	7.7	5.7	3.9	-		
40	-	-	-	22.0	18.5	15.5	13.5	11.0	8.1	5.7	-	-	20.0	16.0	12.5	9.5	7.7	5.7	3.9	-		
44	-	-	-	21.0	17.5	15.0	13.0	11.0	8.0	5.6	-	-	-	15.5	12.5	9.4	7.6	5.6	3.9	-		
48	-	-	-	-	16.5	14.5	12.5	10.5	7.9	5.5	-	-	-	15.5	12.0	9.3	7.5	5.5	3.8	-		
52	-	-	-	-	-	13.5	12.0	10.5	7.7	5.4	-	-	-	12.0	9.2	7.4	5.4	3.8	2.0	-		
56	-	-	-	-	-	13.0	11.5	10.5	7.6	5.3	-	-	-	-	9.1	7.3	5.3	3.7	2.0	-		
60	-	-	-	-	-	-	11.0	10.5	7.5	5.3	-	-	-	-	9.0	7.2	5.3	3.7	2.0	-		
64	-	-	-	-	-	-	10.5	10.0	7.4	5.2	-	-	-	-	-	7.1	5.2	3.7	2.0	-		
68	-	-	-	-	-	-	-	10.0	7.3	5.2	-	-	-	-	-	7.0	5.1	3.6	2.0	-		
72	-	-	-	-	-	-	-	-	7.1	5.1	-	-	-	-	-	-	5.0	3.6	2.0	-		
76	-	-	-	-	-	-	-	-	7.0	5.1	-	-	-	-	-	-	-	3.6	2.0	-		
80	-	-	-	-	-	-	-	-	-	5.0	-	-	-	-	-	-	-	3.5	2.0	-		
84	-	-	-	-	-	-	-	-	-	5.0	-	-	-	-	-	-	-	-	2.0	-		



LIEBHERR LTM 1400

Working ranges
Portées

400 TON

Arbeitsbereiche
Werkbereich

TN 76°

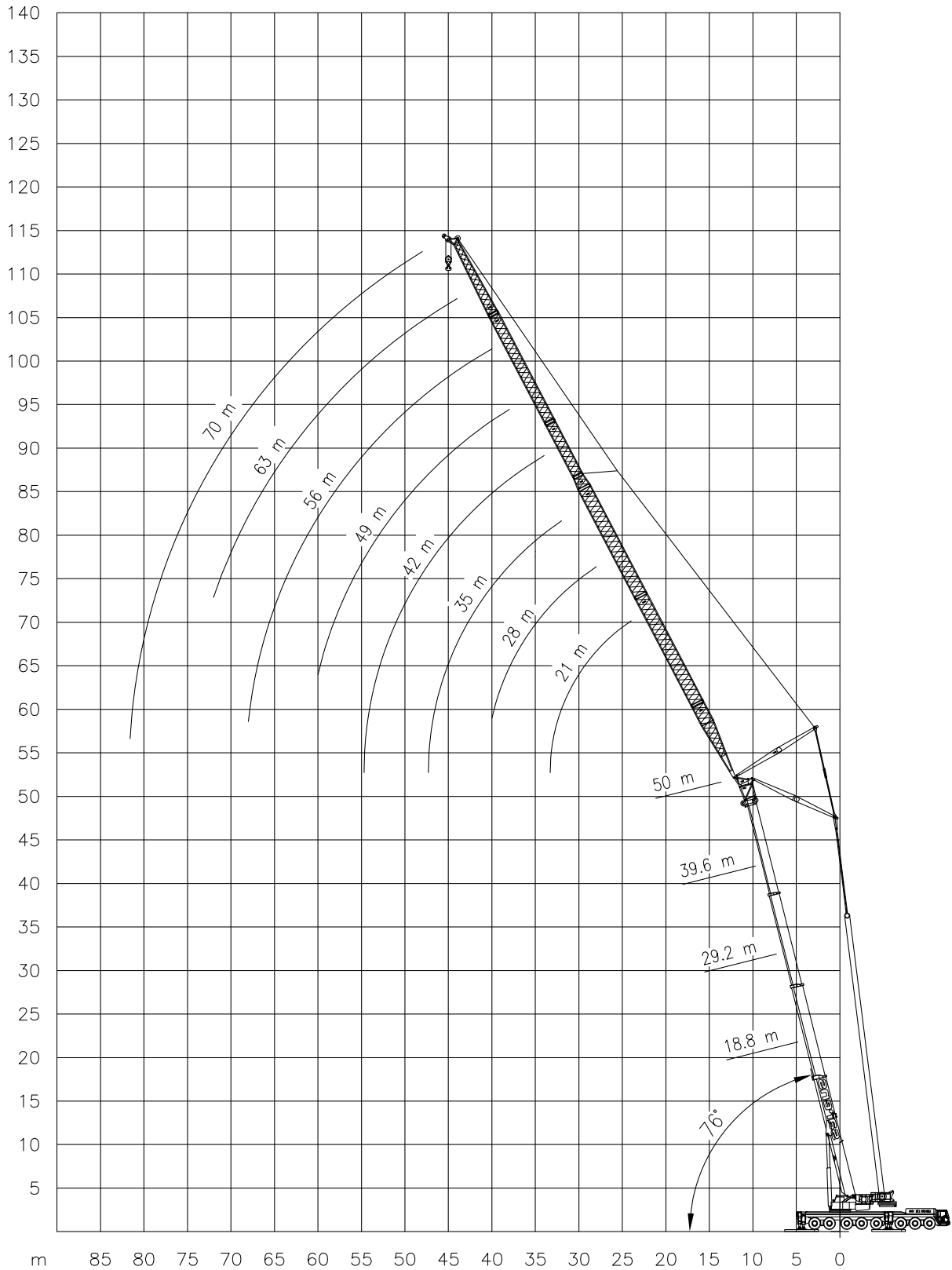



LIEBHERR LTM 1400

400 TON

Lifting capacities
Capacités

Tragfähigkeiten
Capacités

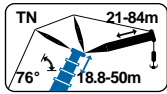

TN 76°

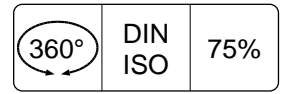

m	18.8 m											29.2 m										
	21m	28m	35m	42m	49m	56m	63m	70m	77m	84m	21m	28m	35m	42m	49m	56m	63m	70m	77m	84m		
	t	t	t	t	t	t	t	t	t	t	t	t	t	t	t	t	t	t	t	t		
14	80.0	-	-	-	-	-	-	-	-	-	-	-	-	-	-	-	-	-	-	-		
16	76.0	-	-	-	-	-	-	-	-	-	-	-	-	-	-	-	-	-	-	-		
18	72.0	64.0	-	-	-	-	-	-	-	-	63.0	-	-	-	-	-	-	-	-	-		
20	68.0	60.0	52.0	-	-	-	-	-	-	-	59.5	52.0	-	-	-	-	-	-	-	-		
22	61.0	57.0	50.0	-	-	-	-	-	-	-	56.5	50.0	-	-	-	-	-	-	-	-		
24	54.0	53.0	48.0	41.0	-	-	-	-	-	-	50.9	48.0	42.0	-	-	-	-	-	-	-		
26	-	49.0	46.0	39.0	35.0	-	-	-	-	-	45.9	45.0	40.0	35.0	-	-	-	-	-	-		
28	-	44.0	43.0	37.5	33.5	-	-	-	-	-	41.6	41.0	38.5	33.5	-	-	-	-	-	-		
30	-	40.0	40.0	36.0	32.0	28.0	-	-	-	-	-	37.5	37.0	32.0	28.0	-	-	-	-	-		
32	-	37.0	37.0	34.0	30.5	27.0	23.5	-	-	-	-	34.5	34.5	31.0	27.0	-	-	-	-	-		
34	-	-	34.0	32.5	29.0	26.0	23.0	-	-	-	-	32.0	31.5	30.0	26.0	22.5	-	-	-	-		
36	-	-	32.0	31.0	28.0	25.0	22.0	19.0	-	-	-	-	29.5	29.0	25.0	21.7	18.5	-	-	-		
38	-	-	30.0	29.5	26.5	24.0	21.5	18.5	14.8	-	-	-	27.5	27.0	24.0	21.0	18.2	15.5	-	-		
40	-	-	-	27.5	25.0	23.0	20.5	18.0	14.4	-	-	-	25.5	25.5	23.5	20.5	17.8	15.2	-	-		
44	-	-	-	24.5	23.0	21.0	19.5	17.5	13.8	10.0	-	-	-	22.5	22.0	19.5	17.0	14.6	11.4	-		
48	-	-	-	-	20.5	19.5	18.0	17.0	13.3	9.6	-	-	-	20.0	19.8	18.3	16.2	14.0	11.0	7.5		
52	-	-	-	-	19.0	18.0	17.0	16.0	12.8	9.2	-	-	-	17.8	17.3	15.5	13.6	10.6	7.2	7.2		
56	-	-	-	-	-	16.5	16.0	15.0	12.2	8.9	-	-	-	16.0	15.6	14.8	13.0	10.2	7.0	7.0		
60	-	-	-	-	-	15.5	15.0	14.5	11.8	8.6	-	-	-	-	14.1	13.6	12.6	9.9	6.8	6.8		
64	-	-	-	-	-	-	14.0	13.5	11.2	8.3	-	-	-	-	-	12.3	11.5	9.6	6.7	6.7		
68	-	-	-	-	-	-	-	12.3	10.8	8.0	-	-	-	-	-	11.2	10.4	9.3	6.5	6.5		
72	-	-	-	-	-	-	-	11.3	10.3	7.8	-	-	-	-	-	-	9.4	8.7	6.4	6.4		
76	-	-	-	-	-	-	-	-	9.8	7.5	-	-	-	-	-	-	8.7	7.8	6.2	6.2		
80	-	-	-	-	-	-	-	-	9.0	7.3	-	-	-	-	-	-	-	7.1	6.0	6.0		
84	-	-	-	-	-	-	-	-	-	7.0	-	-	-	-	-	-	-	-	5.6	5.6		
88	-	-	-	-	-	-	-	-	-	-	-	-	-	-	-	-	-	-	-	5.1		

m	39.6 m											50.0 m										
	21m	28m	35m	42m	49m	56m	63m	70m	77m	84m	21m	28m	35m	42m	49m	56m	63m	70m	77m	84m		
	t	t	t	t	t	t	t	t	t	t	t	t	t	t	t	t	t	t	t	t		
20	40.0	-	-	-	-	-	-	-	-	-	-	-	-	-	-	-	-	-	-	-		
22	39.0	33.0	-	-	-	-	-	-	-	-	-	-	-	-	-	-	-	-	-	-		
24	38.0	32.2	-	-	-	-	-	-	-	-	24.0	-	-	-	-	-	-	-	-	-		
26	37.0	31.5	26.4	-	-	-	-	-	-	-	23.6	-	-	-	-	-	-	-	-	-		
28	36.0	30.8	25.8	-	-	-	-	-	-	-	23.2	20.0	-	-	-	-	-	-	-	-		
30	35.0	30.0	25.2	22.0	-	-	-	-	-	-	22.8	19.6	-	-	-	-	-	-	-	-		
32	-	29.4	24.6	21.5	-	-	-	-	-	-	22.4	19.3	16.0	-	-	-	-	-	-	-		
34	-	28.7	24.0	21.0	18.0	-	-	-	-	-	22.0	19.0	15.7	13.0	-	-	-	-	-	-		
36	-	28.0	23.5	20.5	17.6	14.5	-	-	-	-	-	18.6	15.5	12.8	-	-	-	-	-	-		
38	-	26.2	23.0	20.0	17.2	14.2	-	-	-	-	-	18.3	15.2	12.6	10.0	-	-	-	-	-		
40	-	-	22.5	19.5	16.8	13.9	12.0	-	-	-	-	18.0	15.0	12.4	9.9	8.0	-	-	-	-		
44	-	-	21.4	18.7	16.0	13.4	11.5	9.6	-	-	-	-	14.5	12.0	9.7	7.8	6.0	-	-	-		
48	-	-	-	17.8	15.3	12.8	11.1	9.2	6.8	-	-	-	14.0	11.7	9.3	7.6	5.8	4.0	-	-		
52	-	-	-	16.6	14.6	12.3	10.7	8.9	6.6	4.5	-	-	-	11.3	9.0	7.4	5.7	3.8	-	-		
56	-	-	-	-	14.0	11.8	10.3	8.6	6.3	4.3	-	-	-	11.0	8.8	7.2	5.6	3.7	-	-		
60	-	-	-	-	-	11.4	10.0	8.3	6.1	4.2	-	-	-	-	8.5	7.0	5.4	3.6	-	-		
64	-	-	-	-	-	11.0	9.6	8.1	6.0	4.0	-	-	-	-	-	6.8	5.3	3.5	-	-		
68	-	-	-	-	-	-	9.3	7.9	5.8	3.9	-	-	-	-	-	6.6	5.2	3.4	-	-		
72	-	-	-	-	-	-	8.5	7.6	5.7	3.8	-	-	-	-	-	5.0	3.2	-	-	-		
76	-	-	-	-	-	-	-	6.9	5.6	3.7	-	-	-	-	-	4.8	3.1	-	-	-		
80	-	-	-	-	-	-	-	6.2	5.4	3.6	-	-	-	-	-	-	3.0	-	-	-		
84	-	-	-	-	-	-	-	-	5.0	3.5	-	-	-	-	-	-	3.0	-	-	-		
88	-	-	-	-	-	-	-	-	-	3.5	-	-	-	-	-	-	-	-	-	-		
92	-	-	-	-	-	-	-	-	-	3.3	-	-	-	-	-	-	-	-	-	-		



LIEBHERR LTM 1400

Working ranges
Portées

400 TON

Arbeitsbereiche
Werkbereich

TN 68°

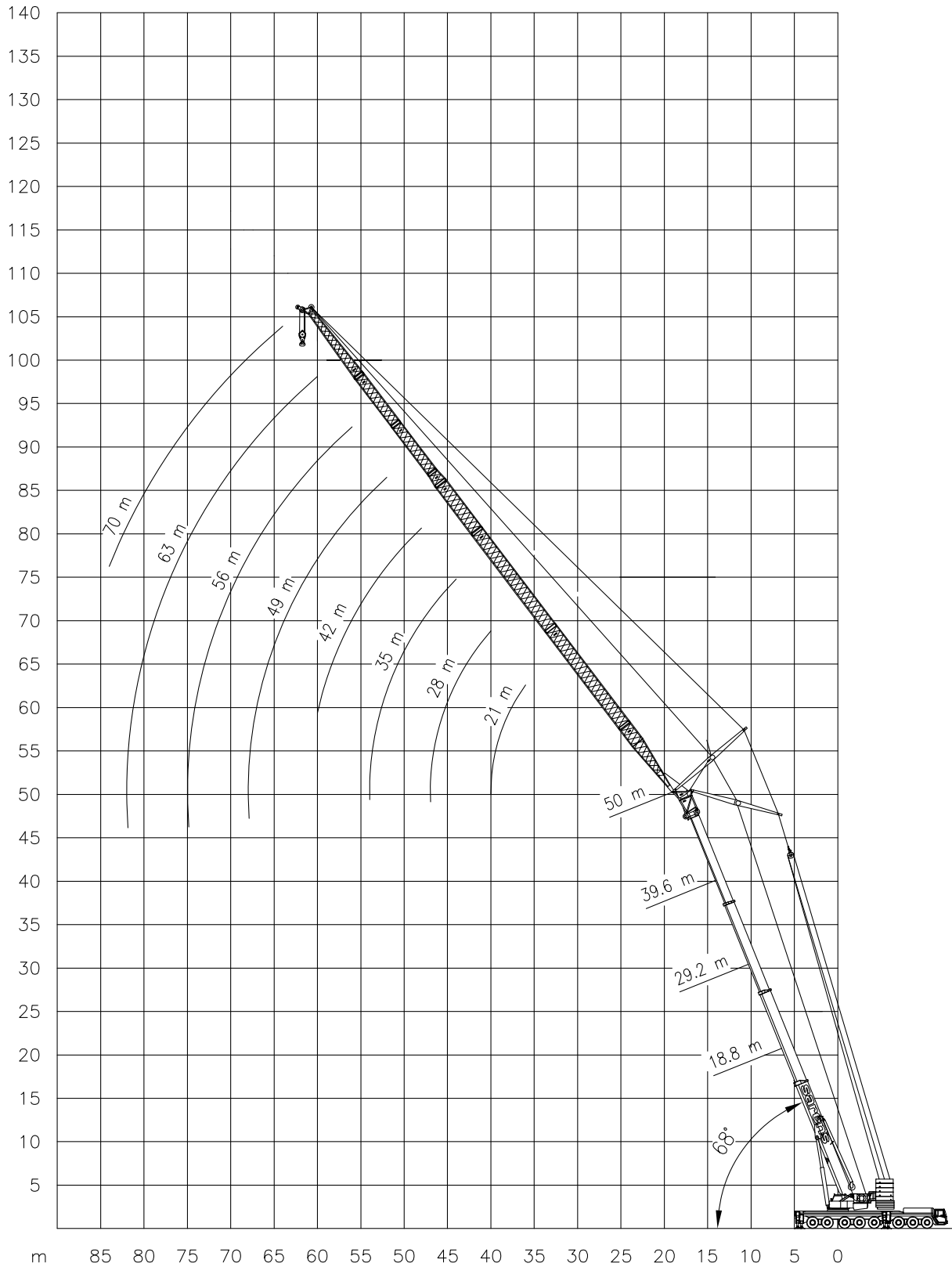



LIEBHERR LTM 1400

Lifting capacities
Capacités

400 TON

Tragfähigkeiten
Capacités

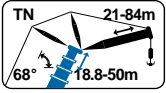

TN 68°



10m

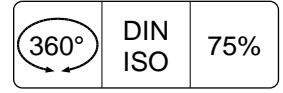
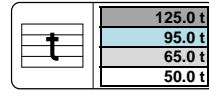

m	18.8 m											29.2 m										
	21m	28m	35m	42m	49m	56m	63m	70m	77m	84m	21m	28m	35m	42m	49m	56m	63m	70m	77m	84m		
	t	t	t	t	t	t	t	t	t	t	t	t	t	t	t	t	t	t	t	t		
20	69.0	-	-	-	-	-	-	-	-	-	-	-	-	-	-	-	-	-	-	-		
22	64.0	-	-	-	-	-	-	-	-	-	-	-	-	-	-	-	-	-	-	-		
24	60.0	54.0	-	-	-	-	-	-	-	-	50.0	-	-	-	-	-	-	-	-	-		
26	56.5	51.0	45.0	-	-	-	-	-	-	-	47.0	-	-	-	-	-	-	-	-	-		
28	-	49.0	43.0	-	-	-	-	-	-	-	44.5	40.0	-	-	-	-	-	-	-	-		
30	-	47.0	41.0	37.0	-	-	-	-	-	-	42.5	38.5	-	-	-	-	-	-	-	-		
32	-	44.0	39.0	35.5	-	-	-	-	-	-	40.0	37.0	34.0	-	-	-	-	-	-	-		
34	-	40.5	37.5	34.0	-	-	-	-	-	-	-	35.5	33.0	-	-	-	-	-	-	-		
36	-	-	36.0	32.5	29.0	-	-	-	-	-	-	34.0	32.0	29.5	-	-	-	-	-	-		
38	-	-	34.5	31.0	27.5	-	-	-	-	-	-	32.0	31.0	28.5	-	-	-	-	-	-		
40	-	-	33.0	30.0	26.0	23.0	-	-	-	-	-	-	30.0	28.0	26.0	-	-	-	-	-		
44	-	-	-	27.5	24.0	21.5	20.0	-	-	-	-	-	26.5	26.0	24.5	21.5	-	-	-	-		
48	-	-	-	25.0	22.0	20.0	19.0	17.5	-	-	-	-	-	23.5	23.0	20.0	17.5	-	-	-		
52	-	-	-	-	20.5	19.0	18.0	17.0	13.0	-	-	-	-	21.0	20.5	19.0	17.0	15.0	-	-		
56	-	-	-	-	-	18.0	17.0	16.0	12.5	8.8	-	-	-	-	18.5	18.0	15.0	14.3	10.6	-		
60	-	-	-	-	-	17.0	16.0	15.5	12.0	8.6	-	-	-	-	17.0	16.5	15.5	13.9	10.3	7.0		
64	-	-	-	-	-	-	15.5	15.0	11.7	8.3	-	-	-	-	15.0	14.5	13.4	10.0	6.8	-		
68	-	-	-	-	-	-	14.5	14.2	11.3	8.0	-	-	-	-	-	13.5	12.9	9.8	6.6	-		
72	-	-	-	-	-	-	-	13.6	11.0	7.8	-	-	-	-	-	12.5	11.8	9.6	6.5	-		
76	-	-	-	-	-	-	-	12.8	10.6	7.6	-	-	-	-	-	-	10.8	9.4	6.4	-		
80	-	-	-	-	-	-	-	-	10.2	7.4	-	-	-	-	-	-	9.9	9.1	6.3	-		
84	-	-	-	-	-	-	-	-	-	7.2	-	-	-	-	-	-	-	8.4	6.2	-		
88	-	-	-	-	-	-	-	-	-	7.0	-	-	-	-	-	-	-	7.8	6.1	-		
92	-	-	-	-	-	-	-	-	-	-	-	-	-	-	-	-	-	-	6.0	-		

m	39.6 m											50.0 m										
	21m	28m	35m	42m	49m	56m	63m	70m	77m	84m	21m	28m	35m	42m	49m	56m	63m	70m	77m	84m		
	t	t	t	t	t	t	t	t	t	t	t	t	t	t	t	t	t	t	t	t		
30	27.5	-	-	-	-	-	-	-	-	-	-	-	-	-	-	-	-	-	-	-		
32	26.5	-	-	-	-	-	-	-	-	-	-	-	-	-	-	-	-	-	-	-		
34	25.5	23.0	-	-	-	-	-	-	-	-	-	-	-	-	-	-	-	-	-	-		
36	25.0	22.5	-	-	-	-	-	-	-	-	15.8	-	-	-	-	-	-	-	-	-		
38	-	22.0	19.0	-	-	-	-	-	-	-	15.5	-	-	-	-	-	-	-	-	-		
40	-	21.5	18.5	-	-	-	-	-	-	-	15.2	13.0	-	-	-	-	-	-	-	-		
44	-	20.5	17.5	15.8	-	-	-	-	-	-	-	12.5	10.0	-	-	-	-	-	-	-		
48	-	-	17.0	15.2	13.5	-	-	-	-	-	-	12.0	9.7	8.0	-	-	-	-	-	-		
52	-	-	-	14.7	13.0	10.8	-	-	-	-	-	-	9.4	7.7	6.0	-	-	-	-	-		
56	-	-	-	14.2	12.6	10.4	8.8	-	-	-	-	-	9.0	7.4	5.7	4.4	-	-	-	-		
60	-	-	-	-	12.2	10.0	8.3	6.8	-	-	-	-	-	7.2	5.4	4.2	3.0	-	-	-		
64	-	-	-	-	12.0	9.7	8.0	6.4	4.8	-	-	-	-	-	5.2	4.0	2.9	2.0	-	-		
68	-	-	-	-	-	9.4	7.7	6.1	4.5	3.0	-	-	-	-	5.0	3.8	2.8	1.9	-	-		
72	-	-	-	-	-	9.1	7.4	5.8	4.3	2.8	-	-	-	-	3.6	2.7	1.8	-	-	-		
76	-	-	-	-	-	-	7.1	5.5	4.1	2.7	-	-	-	-	3.5	2.6	1.7	-	-	-		
80	-	-	-	-	-	-	-	5.2	3.9	2.6	-	-	-	-	-	2.5	1.6	-	-	-		
84	-	-	-	-	-	-	-	5.0	3.7	2.4	-	-	-	-	-	2.4	1.6	-	-	-		
88	-	-	-	-	-	-	-	-	3.6	2.3	-	-	-	-	-	-	-	-	-	-		
92	-	-	-	-	-	-	-	-	3.4	2.2	-	-	-	-	-	-	-	-	-	-		
96	-	-	-	-	-	-	-	-	-	2.1	-	-	-	-	-	-	-	-	-	-		
100	-	-	-	-	-	-	-	-	-	2.0	-	-	-	-	-	-	-	-	-	-		



LIEBHERR LTM 1400

Working ranges
Portées

400 TON

Arbeitsbereiche
Werkbereich

TAN 76°

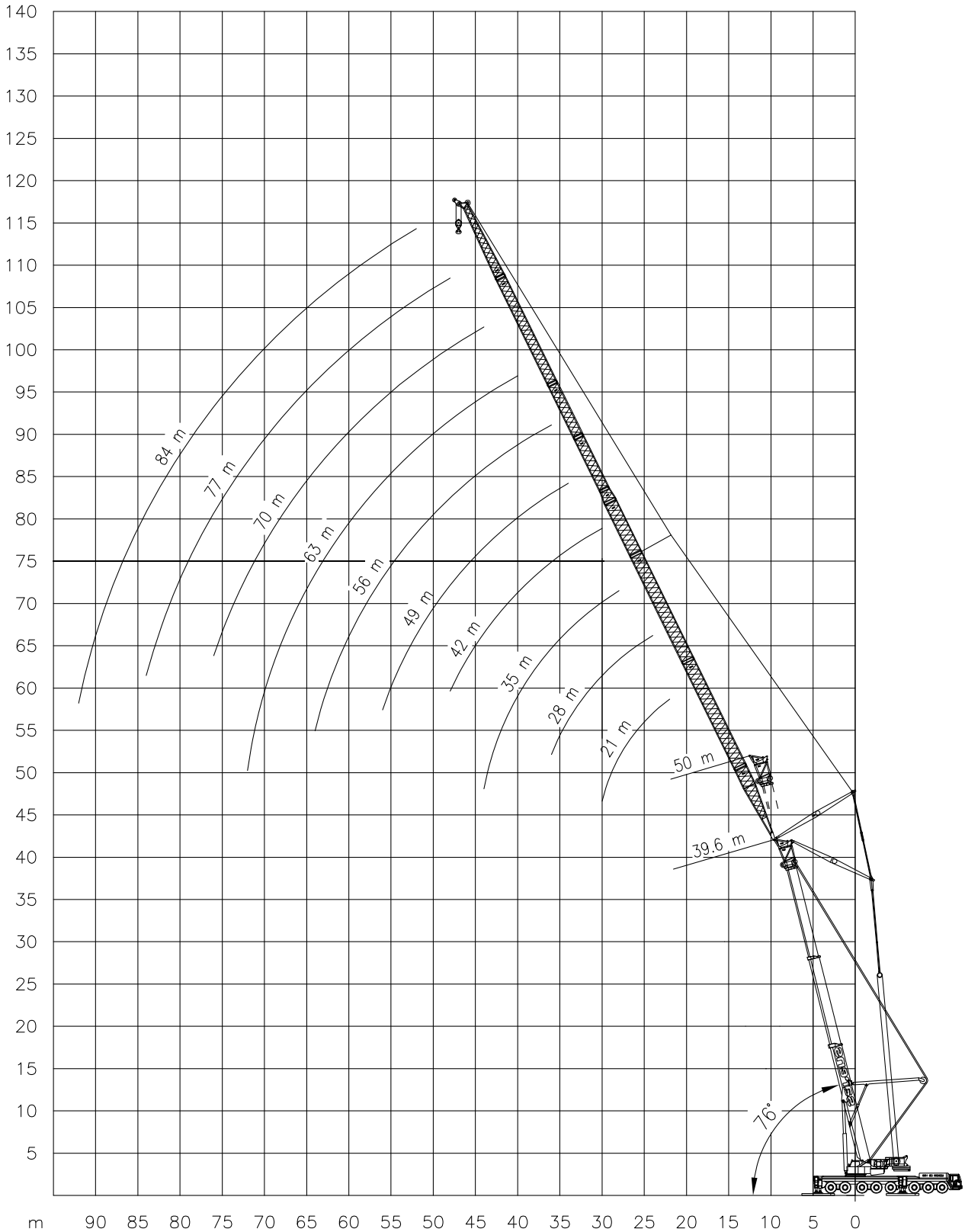



LIEBHERR LTM 1400

Lifting capacities
Capacités

400 TON

Tragfähigkeiten
Capacités

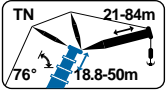

TAN 76°

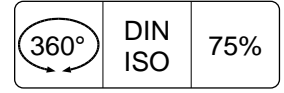
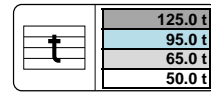

m	39.6 m										
	21m	28m	35m	42m	49m	56m	63m	70m	77m	84m	
	t	t	t	t	t	t	t	t	t	t	
22	46.0	-	-	-	-	-	-	-	-	-	
24	45.5	38.0	-	-	-	-	-	-	-	-	
26	45.0	37.5	-	-	-	-	-	-	-	-	
28	43.5	37.0	31.0	-	-	-	-	-	-	-	
30	40.0	37.0	31.0	25.1	-	-	-	-	-	-	
32	-	36.5	30.5	24.7	-	-	-	-	-	-	
34	-	34.0	29.7	24.3	19.5	-	-	-	-	-	
36	-	31.5	29.3	23.9	19.1	16.3	-	-	-	-	
38	-	-	27.5	23.6	18.8	16.0	-	-	-	-	
40	-	-	24.3	23.3	18.4	15.8	13.0	-	-	-	
44	-	-	-	22.8	17.8	15.4	12.7	10.0	-	-	
48	-	-	-	21.4	17.2	15.0	12.4	9.8	7.6	-	
52	-	-	-	-	16.6	14.6	12.2	9.6	7.4	5.2	
56	-	-	-	-	16.0	14.3	11.9	9.5	7.2	5.0	
60	-	-	-	-	-	13.9	11.7	9.3	7.0	4.9	
64	-	-	-	-	-	13.6	11.5	9.2	6.9	4.8	
68	-	-	-	-	-	-	11.4	9.1	6.8	4.6	
72	-	-	-	-	-	-	11.2	9.0	6.7	4.5	
76	-	-	-	-	-	-	-	8.9	6.7	4.5	
80	-	-	-	-	-	-	-	-	6.6	4.4	
84	-	-	-	-	-	-	-	-	6.5	4.4	
88	-	-	-	-	-	-	-	-	-	4.3	
92	-	-	-	-	-	-	-	-	-	4.3	

m	39.6 m											50.0 m										
	21m	28m	35m	42m	49m	56m	63m	70m	77m	84m	21m	28m	35m	42m	49m	56m	63m	70m	77m	84m		
	t	t	t	t	t	t	t	t	t	t	t	t	t	t	t	t	t	t	t	t		
22	46.0	-	-	-	-	-	-	-	-	-	-	-	-	-	-	-	-	-	-	-		
24	45.0	38.0	-	-	-	-	-	-	-	-	-	-	-	-	-	-	-	-	-	-		
26	42.5	37.5	-	-	-	-	-	-	-	-	26.6	-	-	-	-	-	-	-	-	-		
28	42.5	37.0	31.0	-	-	-	-	-	-	-	26.4	21.9	-	-	-	-	-	-	-	-		
30	39.0	35.0	31.0	25.1	-	-	-	-	-	-	26.3	21.8	-	-	-	-	-	-	-	-		
32	36.5	32.5	30.5	24.7	-	-	-	-	-	-	26.2	21.7	17.6	-	-	-	-	-	-	-		
34	-	30.5	29.4	24.3	19.5	-	-	-	-	-	26.1	21.5	17.4	13.8	-	-	-	-	-	-		
36	-	28.7	27.7	23.9	19.1	16.3	-	-	-	-	-	21.4	17.3	13.6	-	-	-	-	-	-		
38	-	-	26.1	23.6	18.8	16.0	-	-	-	-	-	21.3	17.2	13.5	10.3	-	-	-	-	-		
40	-	-	24.7	23.3	18.4	15.8	13.0	-	-	-	-	21.2	17.1	13.4	10.2	7.9	-	-	-	-		
44	-	-	21.9	21.0	17.8	15.4	12.7	10.0	-	-	-	-	16.9	13.2	9.9	7.7	5.8	-	-	-		
48	-	-	-	19.0	17.2	15.0	12.2	9.8	7.6	-	-	-	-	16.7	13.0	9.7	7.5	5.6	4.0	-		
52	-	-	-	-	16.5	14.5	11.9	9.6	7.4	5.2	-	-	-	12.9	9.5	7.4	5.4	3.8	2.5	-		
56	-	-	-	-	14.9	14.2	11.7	9.5	7.2	5.0	-	-	-	-	9.4	7.2	5.3	3.6	2.4	-		
60	-	-	-	-	-	12.8	10.8	9.3	7.0	4.9	-	-	-	-	9.3	7.1	5.2	3.5	2.3	-		
64	-	-	-	-	-	11.6	9.8	9.2	6.9	4.8	-	-	-	-	-	7.0	5.1	3.3	2.2	-		
68	-	-	-	-	-	-	8.9	8.9	6.8	4.6	-	-	-	-	-	6.9	5.0	3.3	2.2	-		
72	-	-	-	-	-	-	-	8.1	6.7	4.5	-	-	-	-	-	-	4.9	3.2	2.1	-		
76	-	-	-	-	-	-	-	7.3	6.6	4.5	-	-	-	-	-	-	-	3.1	2.1	-		
80	-	-	-	-	-	-	-	-	6.0	4.4	-	-	-	-	-	-	-	-	2.0	-		
84	-	-	-	-	-	-	-	-	5.4	4.4	-	-	-	-	-	-	-	-	2.0	-		
88	-	-	-	-	-	-	-	-	-	4.0	-	-	-	-	-	-	-	-	2.0	-		
92	-	-	-	-	-	-	-	-	-	3.6	-	-	-	-	-	-	-	-	-	-		



LIEBHERR LTM 1400

Working ranges
Portées

400 TON

Arbeitsbereiche
Werkbereich

TAN 68°

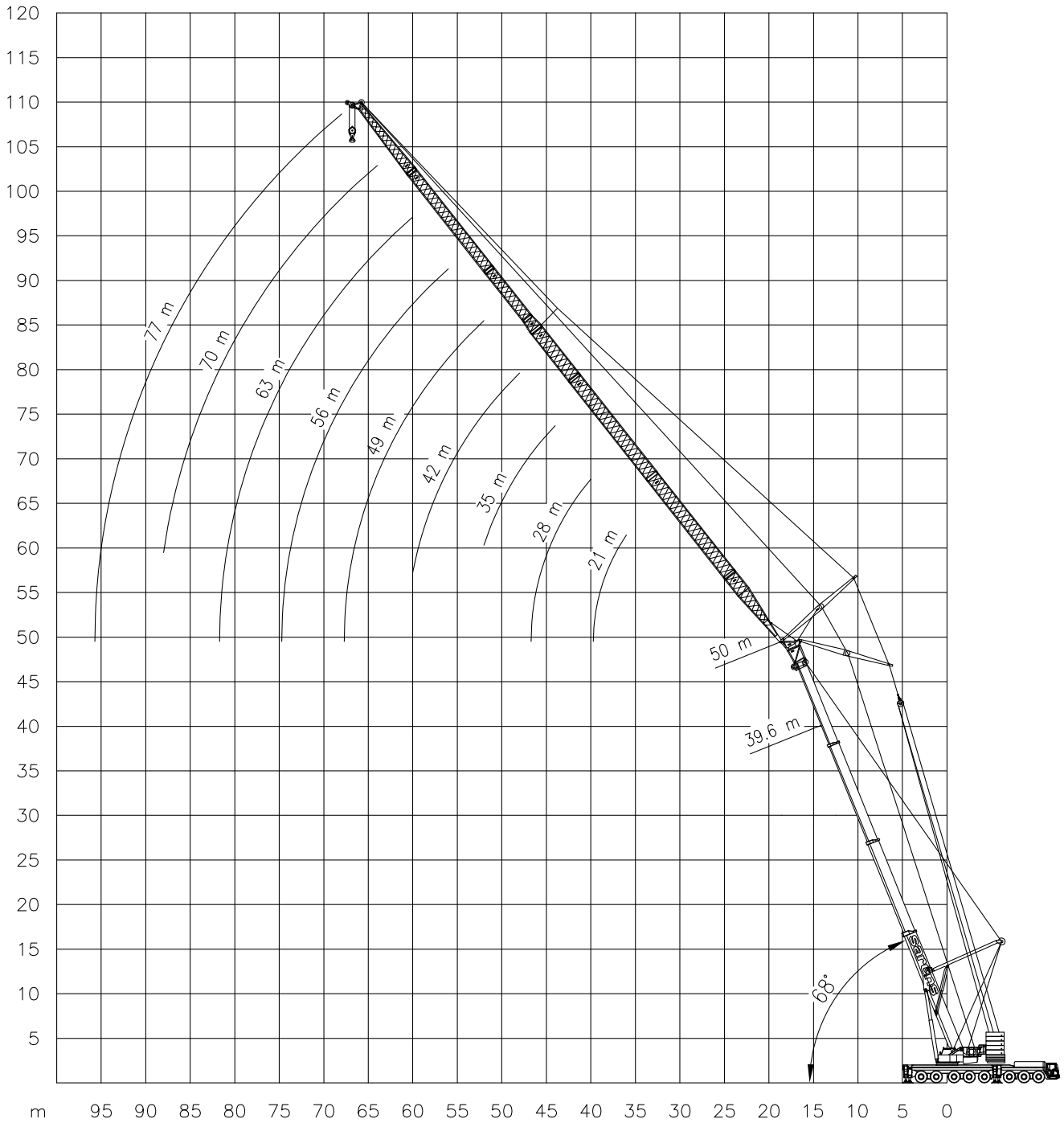



LIEBHERR LTM 1400

Lifting capacities
Capacités

400 TON

Tragfähigkeiten
Capacités

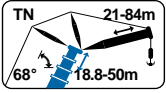

TAN 68°

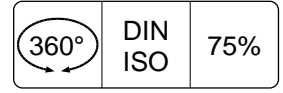
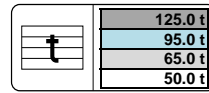

m	39.6 m										50.0 m									
	21m	28m	35m	42m	49m	56m	63m	70m	77m	84m	21m	28m	35m	42m	49m	56m	63m	70m	77m	84m
	t	t	t	t	t	t	t	t	t	t	t	t	t	t	t	t	t	t	t	t
30	34.0	-	-	-	-	-	-	-	-	-	-	-	-	-	-	-	-	-	-	-
32	33.0	-	-	-	-	-	-	-	-	-	-	-	-	-	-	-	-	-	-	-
34	32.5	29.0	-	-	-	-	-	-	-	-	-	-	-	-	-	-	-	-	-	-
36	32.0	28.5	-	-	-	-	-	-	-	-	20.1	-	-	-	-	-	-	-	-	-
38	-	28.1	24.8	-	-	-	-	-	-	-	19.7	-	-	-	-	-	-	-	-	-
40	-	27.8	24.5	-	-	-	-	-	-	-	19.4	17.1	-	-	-	-	-	-	-	-
44	-	-	23.9	20.6	-	-	-	-	-	-	-	16.5	14.0	-	-	-	-	-	-	-
48	-	-	22.0	20.1	17.2	-	-	-	-	-	-	16.0	13.5	11.4	-	-	-	-	-	-
52	-	-	-	19.2	16.7	14.5	-	-	-	-	-	-	13.1	11.0	9.2	-	-	-	-	-
56	-	-	-	17.4	13.6	14.1	11.8	-	-	-	-	-	-	10.6	8.8	7.1	-	-	-	-
60	-	-	-	-	15.5	13.8	11.5	9.1	-	-	-	-	-	10.2	8.4	6.7	5.2	-	-	-
64	-	-	-	-	14.2	13.4	11.2	8.8	6.9	-	-	-	-	8.1	6.4	4.9	3.8	-	-	-
68	-	-	-	-	-	12.2	10.9	8.5	6.7	4.8	-	-	-	7.8	6.2	4.7	3.5	2.6	-	-
72	-	-	-	-	-	-	9.7	8.3	6.5	4.6	-	-	-	-	6.0	4.5	3.3	2.4	-	-
76	-	-	-	-	-	-	-	8.1	6.3	4.4	-	-	-	-	5.8	4.4	3.1	2.2	-	-
80	-	-	-	-	-	-	-	7.9	6.1	4.2	-	-	-	-	-	4.3	3.0	2.1	-	-
84	-	-	-	-	-	-	-	7.5	6.0	4.1	-	-	-	-	-	4.2	2.9	2.0	-	-
88	-	-	-	-	-	-	-	-	5.9	4.0	-	-	-	-	-	-	2.8	1.9	-	-
92	-	-	-	-	-	-	-	-	5.7	3.9	-	-	-	-	-	-	-	1.8	-	-
96	-	-	-	-	-	-	-	-	-	3.8	-	-	-	-	-	-	-	-	1.7	-
100	-	-	-	-	-	-	-	-	-	3.7	-	-	-	-	-	-	-	-	-	-

m	39.6 m										50.0 m									
	21m	28m	35m	42m	49m	56m	63m	70m	77m	84m	21m	28m	35m	42m	49m	56m	63m	70m	77m	84m
	t	t	t	t	t	t	t	t	t	t	t	t	t	t	t	t	t	t	t	t
30	32.0	-	-	-	-	-	-	-	-	-	-	-	-	-	-	-	-	-	-	-
32	29.7	-	-	-	-	-	-	-	-	-	-	-	-	-	-	-	-	-	-	-
34	27.8	26.5	-	-	-	-	-	-	-	-	-	-	-	-	-	-	-	-	-	-
36	25.7	24.9	-	-	-	-	-	-	-	-	20.1	-	-	-	-	-	-	-	-	-
38	-	23.4	22.4	-	-	-	-	-	-	-	19.7	-	-	-	-	-	-	-	-	-
40	-	22.1	21.1	-	-	-	-	-	-	-	19.4	17.1	-	-	-	-	-	-	-	-
44	-	-	18.9	17.8	-	-	-	-	-	-	-	16.5	14.0	-	-	-	-	-	-	-
48	-	-	17.1	16.0	15.3	-	-	-	-	-	-	15.5	13.5	11.4	-	-	-	-	-	-
52	-	-	-	14.5	13.8	12.7	-	-	-	-	-	-	13.1	11.0	9.2	-	-	-	-	-
56	-	-	-	13.0	12.4	11.4	10.5	-	-	-	-	-	-	10.6	8.8	7.1	-	-	-	-
60	-	-	-	-	11.2	10.2	9.3	8.5	-	-	-	-	-	9.8	8.4	6.7	5.2	-	-	-
64	-	-	-	-	10.1	9.2	8.3	7.4	6.8	-	-	-	-	8.0	6.4	4.9	3.8	-	-	-
68	-	-	-	-	-	8.3	7.4	6.5	5.9	4.8	-	-	-	7.2	6.2	4.7	3.5	-	-	-
72	-	-	-	-	-	-	6.6	5.8	5.1	4.2	-	-	-	-	5.6	4.5	3.3	-	-	-
76	-	-	-	-	-	-	6.0	5.2	4.4	3.6	-	-	-	-	5.1	4.2	3.1	-	-	-
80	-	-	-	-	-	-	-	4.7	3.9	3.1	-	-	-	-	-	3.8	3.0	-	-	-
84	-	-	-	-	-	-	-	4.3	3.5	2.7	-	-	-	-	-	3.5	2.7	-	-	-
88	-	-	-	-	-	-	-	-	3.1	2.3	-	-	-	-	-	-	2.4	-	-	-
92	-	-	-	-	-	-	-	-	2.8	2.0	-	-	-	-	-	-	-	-	-	-
96	-	-	-	-	-	-	-	-	-	1.7	-	-	-	-	-	-	-	-	-	-
100	-	-	-	-	-	-	-	-	-	1.5	-	-	-	-	-	-	-	-	-	-



LIEBHERR LTM 1400

400 TON

Working speeds
Vitesses de travail

Arbeitsgeschwindigkeiten
Werksnelheden

Mechanisms Mécanismes Antriebe Aandrijvingen	Speeds Vitesses Geschwindigkeiten Snelheden	Rope diameter Diamètre du câble Seildurchmesser Kabeldiameter	Single line pull Effort sur brin simple Zulässiger Seilzug je strang Toegelaten trekkraft / part	Length of ropes Longueur des cables Länge der Seile Kabellengte
Main hoist Levage sur flèche Hubwerk 1 Hijslier 1	0 – 160 m/min	25 mm	120 kN	480 m
Auxiliary hoist 2 Levage sur flèche 2 Hubwerk 2 Hijslier 2	0 – 160 m/min	25 mm	120 kN	750 m
Slewing gear Orientation Drehwerk Zwenkwerk	0 – 1.2 RPM			
Travel speed Vitesse sur route Fahrgeschwindigkeit Rijsnelheid	0 – 31/65 km/h			
Booming up Relever la flèche Aufwippen Optoppen	83° 100 sec			
Telescope Téléscoper Teleskopieren Telescoperen	15.7 - 50 m 300 sec			

Hook Block / Crane hook Crochet mouflé / Crochet simple

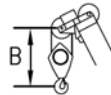

Unterflasche / Hakengehänge Kraanblok / Kraanhaak

Capacity Capacité Tragfähigkeit Capaciteit	Number of sheaves Nombre de poulies Anzahl der Rollen Aantal schijven	Number of lines Nombre de brins Strangzahl Aantal parten	Weight Poids Gewicht Gewicht	"B"
SWL 230 t	11	22	2600 kg	3.8 m
SWL 155 t	7	14	2000 kg	3.4 m
SWL 81 t	3	7	1500 kg	3.2 m
SWL 36 t	1	3	1000 kg	3.0 m
SWL 12 t	-	1	500 kg	2.5 m