



DEMAG AC100/4 | All Terrain Crane 120 t Lifting Capacity



DEMAG AC100/4
ALL TERRAIN CRANE



HIGHLIGHTS

DEMAG AC100/4
HIGHLIGHTS

- Strongest 4-axle crane in all working configurations
- Only 4-axle crane with only 8.4 ft width on 16.00 R 25 tires
- 15,200 lb counterweight within 26,500 lb axle load, 47,000 lb within 35,300 lb axle load roadable
- High and economic road and crane performance due to powerful and modern drive train technology
- Most variable main boom extension system in its class
- 4 outrigger bases, outrigger pressure control and air-conditions serial





CONTENTS

		Page:	
Specifications		4	1
	HA Main boom	8	2
	HAV Folding swing-away jib	12	3
	HAV-VA Variable extension with swing-away jib	15	4
	MS Runner	17	5
Equipment		20	6



DIMENSIONS

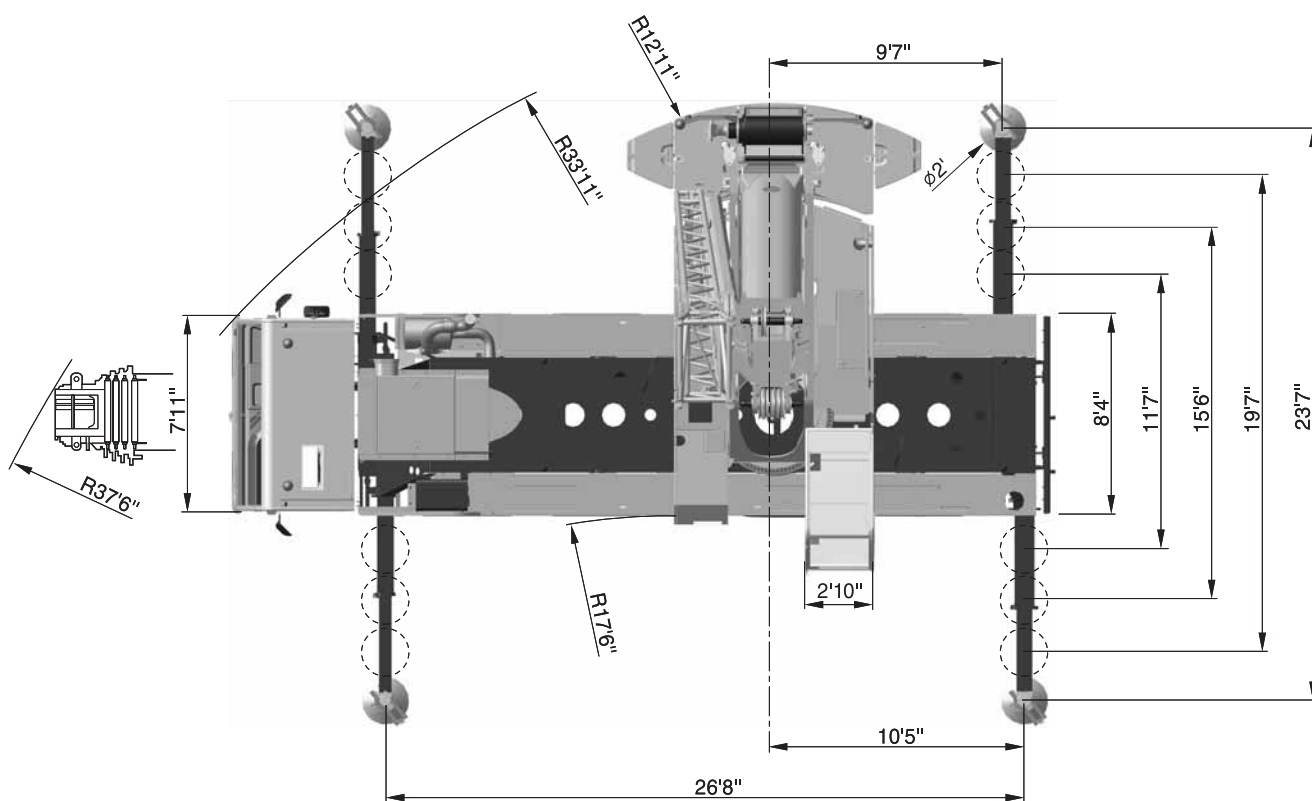
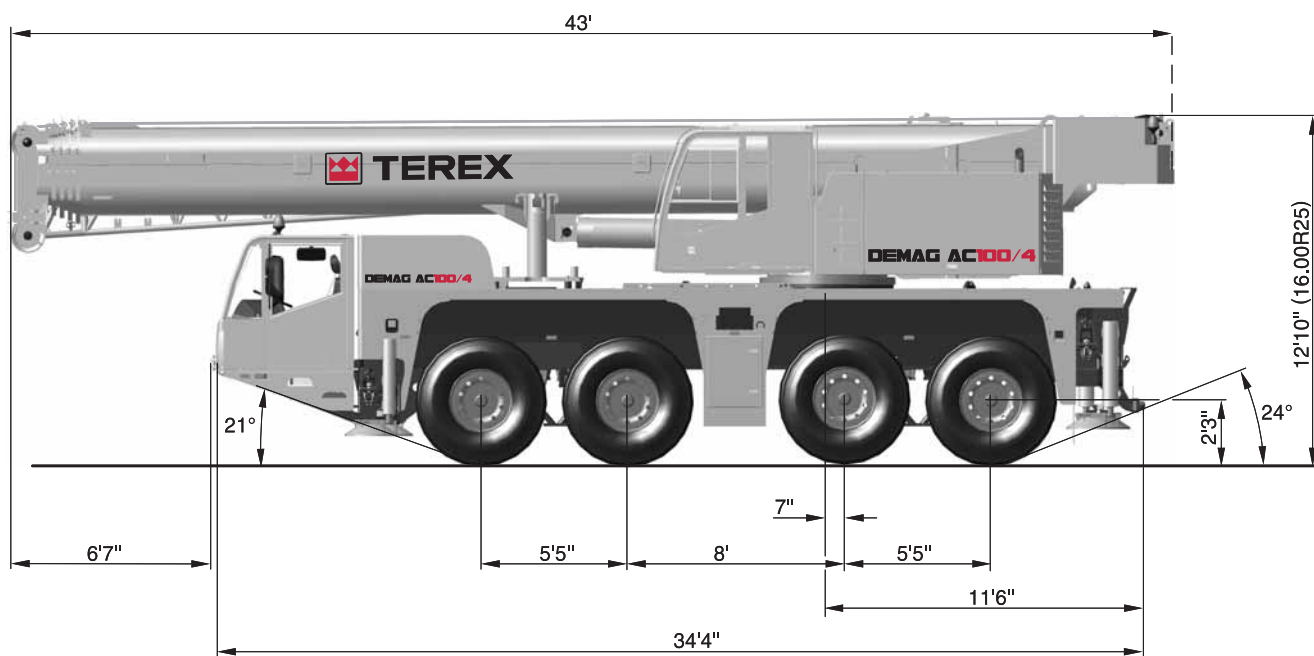



DEMAG AC100/4
ALL TERRAIN CRANE

SPECIFICATIONS

	Total							
< 22,100 lb				On request!				X
< 26,500 lb	88,200 lb	8 x 6 x 8	14.00 R 25	8-0-18	-	-	-	-
< 26,500 lb	105,800 lb	8 x 8 x 8	16.00 R 25	20-1-18	11,900 lb	62.3 ft	-	-
< 26,500 lb	105,800 lb	8 x 8 x 8	16.00 R 25	20-1-18	15,200 lb	-	-	-
< 28,700 lb	110,300 lb	8 x 8 x 8	16.00 R 25	50-3-18	15,200 lb	62.3 ft	-	-
< 28,700 lb	114,700 lb	8 x 8 x 8	16.00 R 25	50-3-18	22,300 lb	62.3 ft	-	-
< 32,000 lb	125,700 lb	8 x 8 x 8	16.00 R 25	50-3-18	30,400 lb	62.3 ft	-	-
< 32,000 lb	127,900 lb	8 x 8 x 8	16.00 R 25	50-3-18	33,700 lb	32.8 ft	-	-
< 35,300 lb	114,100 lb	8 x 8 x 8	16.00 R 25	50-3-18	47,000 lb	62.3 ft	-	-
	14.00 R 25 395/95 R 25 X	16.00 R 25 445/95 R 25 X	17.50 R 25	20.50 R 25				
	52.8 mph	52.8 mph	52.8 mph	52.8 mph				
	45 %	45 %	40 %	40 %				
	> 70 %	> 60 %	> 70 %	> 60 %				
	1 Highway > 28.0 mph Axles 3 + 4 rigid							
	2 City < 28.0 mph Axle 4 with speed dependent steering							
	3* Minimum turning radius < 3.1 mph Axles 3 + 4 steered automatically							
	4* Off-wall No tail swing							
	5* Crab steer mode All axles in the same direction							
	6* All wheel steering Axles 3 + 4 manually steerable							
* must be activated								
1,4 min ⁻¹					377 ft/min	377 ft/min		
	14,500 lb	0,71"	870 ft					
	14,500 lb	0,71"	870 ft					
100-7-18	7	15	208,400 lb	1654 lb	6.6 ft	8		
80-5-18	5	11	155,900 lb	1433 lb	6.6 ft	6		
50-3-18	3	7	101,200 lb	1212 lb	5.9 ft	5		
20-1-18	1	3	44,100 lb	772 lb	5.9 ft	5		
8-0-18	-	1	15,000 lb	375 lb	3.3 ft	5		

1



EQUIPMENT

HAV / HAV-VA

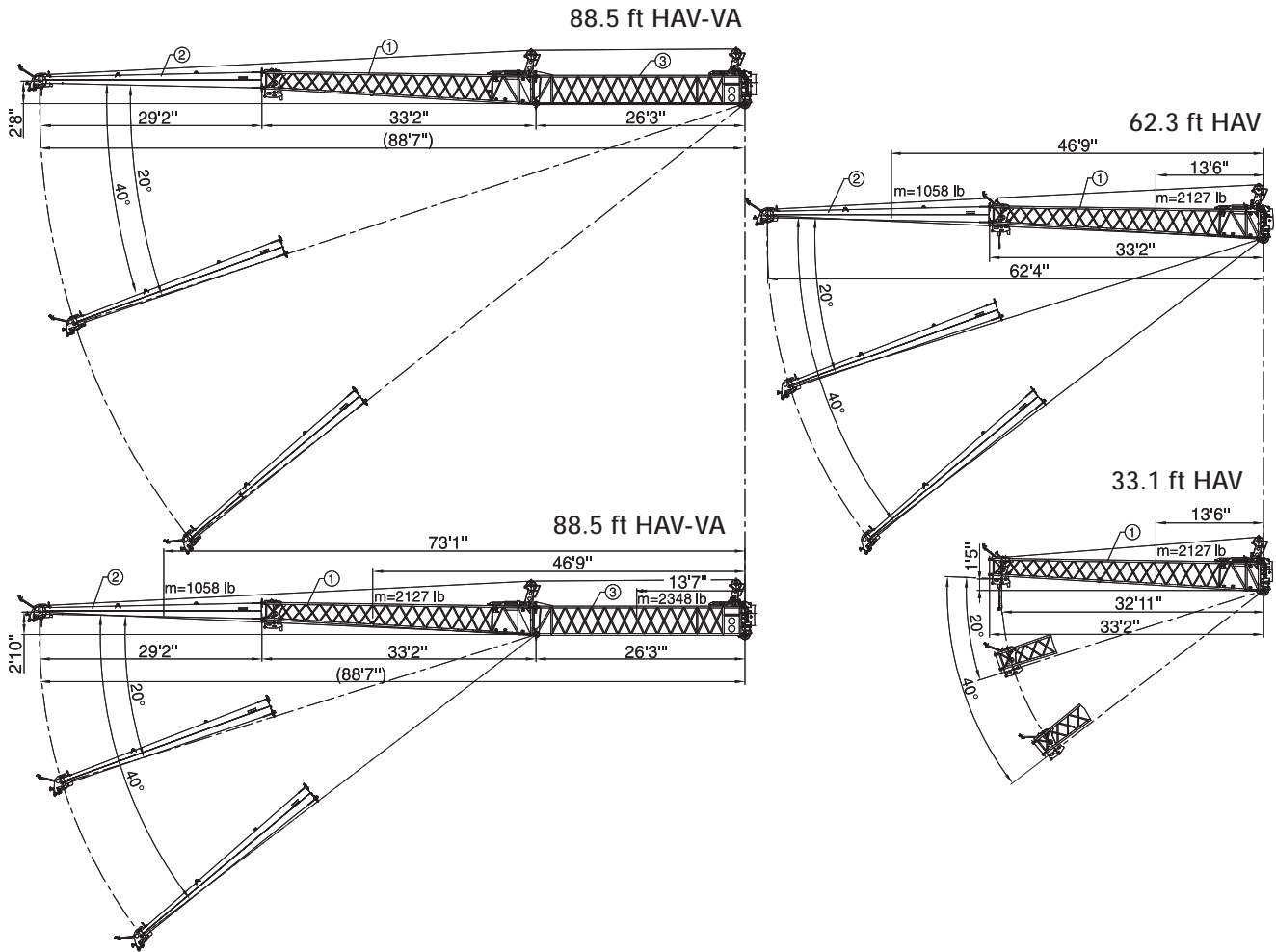

MS

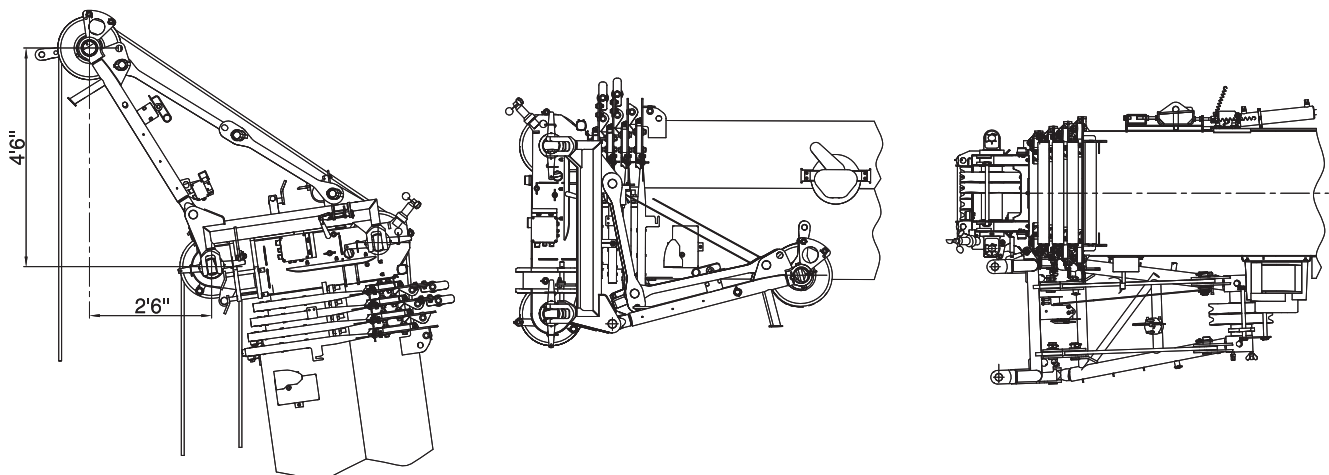

**DEMAG AC100/4**
ALL TERRAIN CRANE

1

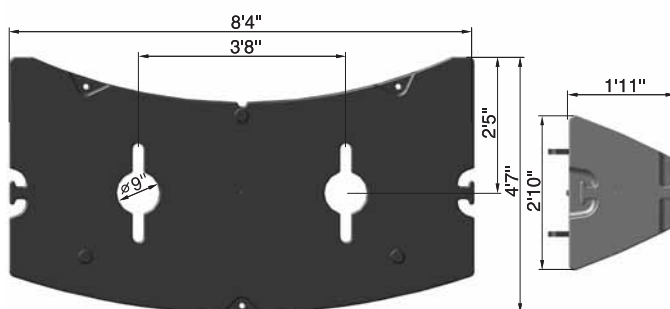
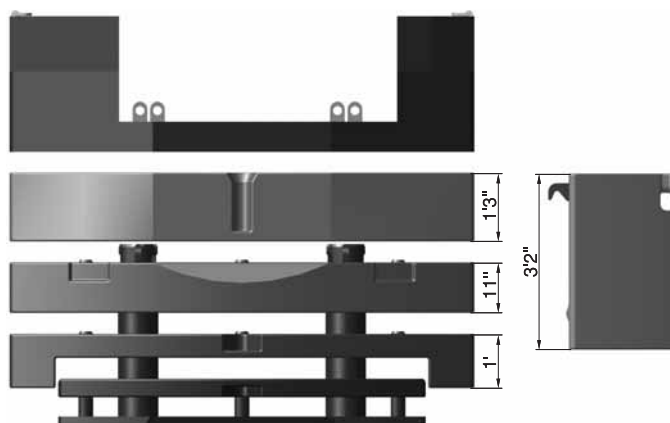
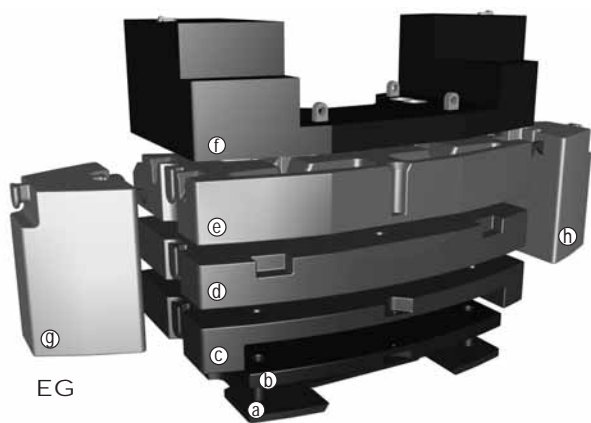
COUNTERWEIGHT**PARTS****CONFIGURATIONS**

	EG	NEG	(a) 1,540 lb	(b) 3,310 lb	(c) 7,060 lb	(d) 11,470 lb	(e) 13,230 lb	(f) 10,360 lb	(g) 5,290 lb	(h) 5,290 lb	(i) 10,360 lb
1,540 lb	X	X	X								
4,850 lb	X	X	X	X							
8,600 lb	X	X	X		X						
10,360 lb	X							X			
11,900 lb	X		X					X			
11,900 lb	X	X	X	X	X						
15,200 lb	X		X	X				X			
19,000 lb	X		X		X			X			
20,000 lb	X	X	X		X	X					
22,300 lb	X		X	X	X			X			
23,400 lb	X	X	X	X	X	X					
30,400 lb	X		X		X	X		X			
33,300 lb	X	X	X		X	X	X				
33,700 lb	X		X	X	X	X		X			
36,400 lb	X	X	X	X	X	X	X				
43,700 lb	X		X		X	X	X	X			
43,900 lb	X	X	X		X	X	X		X	X	
47,000 lb	X		X	X	X	X	X	X			
47,200 lb	X	X	X	X	X	X	X		X	X	
54,200 lb	X		X		X	X	X	X	X	X	
54,200 lb		X	X		X	X	X		X	X	X
57,500 lb	X		X	X	X	X	X	X	X	X	
57,500 lb		X	X	X	X	X	X		X	X	X



HA

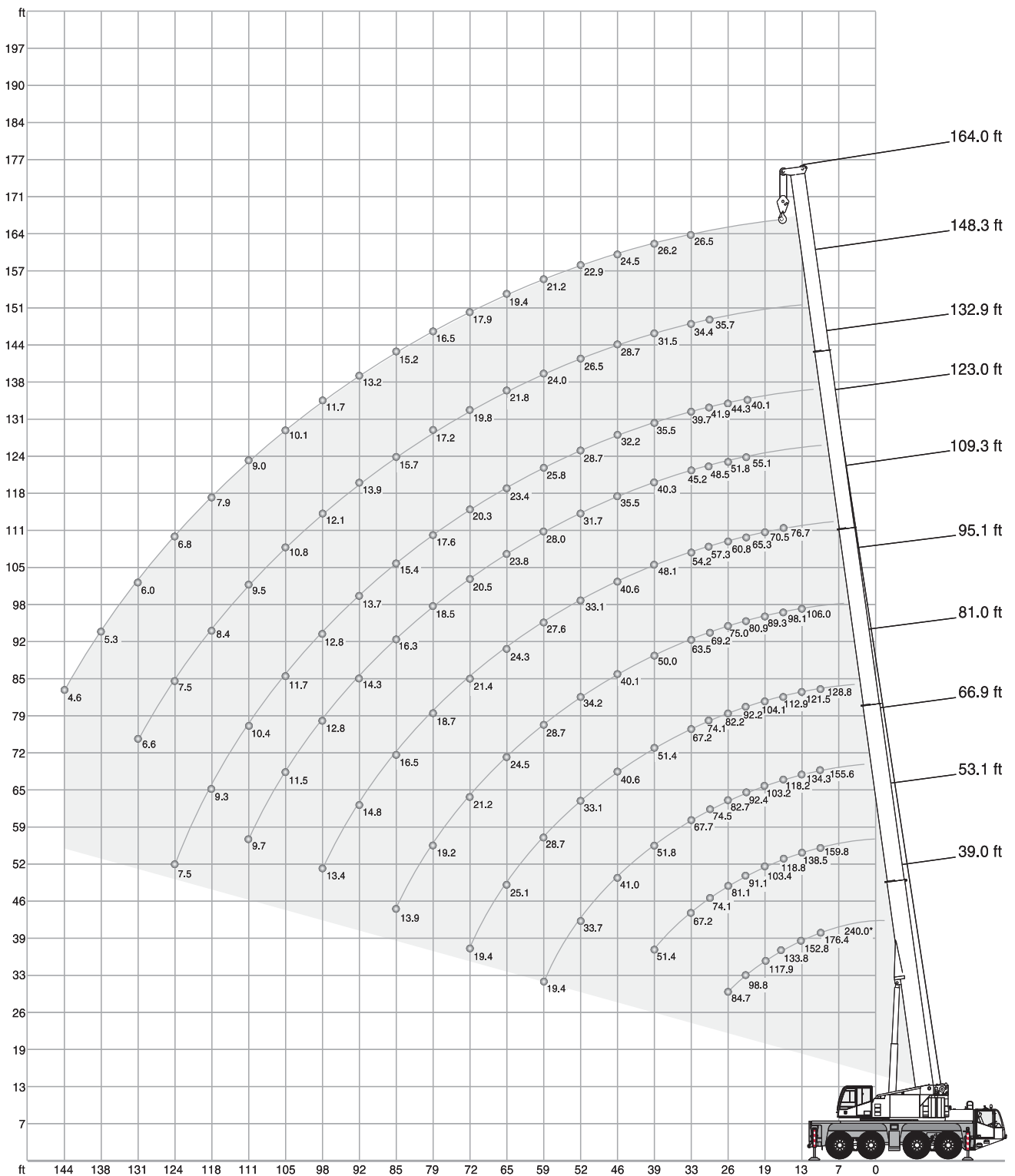



DEMAG AC100/4
ALL TERRAIN CRANE

HA

57,500 lb		26.6 ft x 23.6 ft										360°		85 %	
ft		1,000 lb										ft			
	(0°)	39.0 ft	53.1 ft	66.9 ft	81.0 ft	95.1 ft	109.3 ft	123.0 ft	132.9 ft	148.3 ft	164.0 ft				
	240.0*	-	-	-	-	-	-	-	-	-	-				
10	176.4	163.6	159.8	155.6	128.8	-	-	-	-	-	-		10		
11	163.8	149.9	148.4	144.2	128.8	-	-	-	-	-	-		11		
13	152.8	138.2	138.5	134.3	121.5	106.0	-	-	-	-	-		13		
15	142.9	127.2	128.3	125.7	116.6	102.1	-	-	-	-	-		15		
16	133.8	117.7	118.8	118.2	112.9	98.1	76.7	-	-	-	-		16		
19	117.9	102.1	103.4	103.2	104.1	89.3	70.5	-	-	-	-		19		
23	98.8	89.9	91.1	92.4	92.2	80.9	65.3	55.1	40.1	-	-		23		
26	84.7	80.0	81.1	82.7	82.2	75.0	60.8	51.8	44.3	-	-		26		
29	-	-	74.1	74.5	74.1	69.2	57.3	48.5	41.9	35.7	-		29		
33	-	-	67.2	67.7	67.2	63.5	54.2	45.2	39.7	34.4	26.5		33		
39	-	-	51.4	51.8	51.4	50.0	48.1	40.3	35.5	31.5	26.2		39		
46	-	-	-	41.0	40.6	40.1	40.6	35.5	32.2	28.7	24.5		46		
52	-	-	-	33.7	33.1	34.2	33.1	31.7	28.7	26.5	22.9		52		
59	-	-	-	19.4	28.7	28.7	27.6	28.0	25.8	24.0	21.2		59		
65	-	-	-	-	25.1	24.5	24.3	23.8	23.4	21.8	19.4		65		
72	-	-	-	-	19.4	21.2	21.4	20.5	20.3	19.8	17.9		72		
79	-	-	-	-	-	19.2	18.7	18.5	17.6	17.2	16.5		79		
85	-	-	-	-	-	13.9	16.5	16.3	15.4	15.7	15.2		85		
92	-	-	-	-	-	-	14.8	14.3	13.7	13.9	13.2		92		
98	-	-	-	-	-	-	13.4	12.8	12.8	12.1	11.7		98		
105	-	-	-	-	-	-	-	11.5	11.7	10.8	10.1		105		
111	-	-	-	-	-	-	-	9.7	10.4	9.5	9.0		111		
118	-	-	-	-	-	-	-	-	9.3	8.4	7.9		118		
124	-	-	-	-	-	-	-	-	7.5	7.5	6.8		124		
131	-	-	-	-	-	-	-	-	-	6.6	6.0		131		
138	-	-	-	-	-	-	-	-	-	-	5.3		138		
144	-	-	-	-	-	-	-	-	-	-	4.6		144		
151	-	-	-	-	-	-	-	-	-	-	-		151		

47,000 lb (47,200 lb)		26.6 ft x 23.6 ft										360°		85 %	
ft		1,000 lb										ft			
		39.0 ft	53.1 ft	66.9 ft	81.0 ft	95.1 ft	109.3 ft	123.0 ft	132.9 ft	148.3 ft	164.0 ft				
10	163.1	159.8	155.6	128.8	-	-	-	-	-	-	-		10		
11	149.5	148.4	144.2	128.8	-	-	-	-	-	-	-		11		
13	136.9	138.0	134.3	121.5	106.0	-	-	-	-	-	-		13		
15	125.9	127.0	125.7	116.6	102.1	-	-	-	-	-	-		15		
16	116.6	117.7	117.5	112.9	98.1	76.7	-	-	-	-	-		16		
19	101.2	102.3	102.1	103.2	89.3	70.5	-	-	-	-	-		19		
23	88.8	90.2	91.5	91.1	80.9	65.3	55.1	40.1	-	-	-		23		
26	79.1	80.7	81.8	81.4	75.0	60.8	51.8	44.3	-	-	-		26		
29	-	72.5	73.0	72.5	68.1	57.3	48.5	41.9	35.7	-	-		29		
33	-	60.8	61.5	61.1	59.7	54.2	45.2	39.7	34.4	26.5	-		33		
39	-	45.6	46.1	45.6	45.0	45.6	40.3	35.5	31.5	26.2	-		39		
46	-	-	36.4	36.2	37.0	35.7	34.8	32.2	28.7	24.5	-		46		
52	-	-	30.6	30.6	30.2	29.8	29.5	28.0	26.5	22.9	-		52		
59	-	-	19.4	25.8	25.4	25.6	24.5	24.5	23.8	21.2	-		59		
65	-	-	-	22.0	22.3	21.6	21.4	20.7	20.1	19.4	-		65		
72	-	-	-	19.2	19.2	18.7	18.3	17.6	17.9	17.2	-		72		
79	-	-	-	-	16.8	16.5	16.1	15.9	15.4	15.0	-		79		
85	-	-	-	-	13.9	14.6	14.1	14.1	13.4	12.8	-		85		
92	-	-	-	-	-	12.8	12.3	12.6	11.7	11.0	-		92		
98	-	-	-	-	-	11.5	10.8	11.0	10.1	9.7	-		98		
105	-	-	-	-	-	-	9.7	9.7	8.8	8.4	-		105		
111	-	-	-	-	-	-	-	7.9	8.6	7.7	-		111		
118	-	-	-	-	-	-	-	-	7.7	6.8	-		118		
124	-	-	-	-	-	-	-	-	6.0	6.0	-		124		
131	-	-	-	-	-	-	-	-	-	5.3	-		131		
138	-	-	-	-	-	-	-	-	-	-	4.0		138		
144	-	-	-	-	-	-	-	-	-	-	3.3		144		

* with special attachment

**HA**





	33,700 lb (33,300 lb)		26.6 ft x 23.6 ft	360°	85 %
--	------------------------------	--	--------------------------	-------------	-------------





		39.0 ft	53.1 ft	66.9 ft	81.0 ft	95.1 ft	109.3 ft	123.0 ft	132.9 ft	148.3 ft	164.0 ft	
ft						1,000 lb						ft
10		162.5	159.8	155.6	128.8	-	-	-	-	-	-	10
11		147.7	148.4	144.2	128.8	-	-	-	-	-	-	11
13		135.1	136.2	134.3	121.5	106.0	-	-	-	-	-	13
15		124.3	125.4	125.2	116.6	102.1	-	-	-	-	-	15
16		115.1	116.2	116.0	112.9	98.1	76.7	-	-	-	-	16
19		99.9	101.0	101.4	101.9	89.3	70.5	-	-	-	-	19
23		87.7	88.8	90.4	86.9	79.6	65.3	55.1	40.1	-	-	23
26		72.1	75.6	76.5	73.0	67.2	60.8	51.8	44.3	-	-	26
29		-	61.7	62.4	61.7	57.8	56.7	48.5	41.9	35.7	-	29
33		-	51.6	52.2	51.8	50.5	49.6	45.2	39.7	34.4	26.5	33
39		-	38.4	39.5	40.1	39.7	38.4	38.6	35.3	31.5	26.2	39
46		-	-	31.5	31.7	31.1	31.5	30.4	30.2	28.7	24.5	46
52		-	-	25.6	25.8	26.0	25.6	25.1	24.5	24.0	22.9	52
59		-	-	19.4	21.8	21.6	21.4	20.9	21.2	20.3	19.8	59
65		-	-	-	18.5	18.3	18.1	17.6	17.9	17.0	16.5	65
72		-	-	-	15.9	15.9	15.4	15.0	15.2	14.3	13.9	72
79		-	-	-	-	13.9	13.4	13.0	13.0	12.3	11.7	79
85		-	-	-	-	12.1	11.7	11.2	11.2	10.6	9.9	85
92		-	-	-	-	-	10.1	9.7	9.7	9.0	8.4	92
98		-	-	-	-	-	8.8	8.4	8.6	7.7	7.1	98
105		-	-	-	-	-	-	7.3	7.5	6.6	6.0	105
111		-	-	-	-	-	-	5.7	6.4	5.5	5.1	111
118		-	-	-	-	-	-	-	5.5	4.6	4.2	118
124		-	-	-	-	-	-	-	4.0	4.0	3.3	124
131		-	-	-	-	-	-	-	-	3.3	2.6	131
138		-	-	-	-	-	-	-	-	-	2.2	138
144		-	-	-	-	-	-	-	-	-	1.5	144

	22,300 lb		26.6 ft x 23.6 ft	360°	85 %
--	------------------	--	--------------------------	-------------	-------------

		39.0 ft	53.1 ft	66.9 ft	81.0 ft	95.1 ft	109.3 ft	123.0 ft	132.9 ft	148.3 ft	164.0 ft	
ft						1,000 lb						ft
10		161.2	159.8	155.6	128.8	-	-	-	-	-	-	10
11		146.2	147.3	144.2	128.8	-	-	-	-	-	-	11
13		133.6	134.7	134.3	121.5	106.0	-	-	-	-	-	13
15		123.0	124.1	123.9	116.6	102.1	-	-	-	-	-	15
16		113.8	114.9	114.9	112.9	98.1	76.7	-	-	-	-	16
19		98.8	99.9	100.5	92.4	83.8	70.5	-	-	-	-	19
23		79.8	84.0	80.9	75.2	68.8	65.3	55.1	40.1	-	-	23
26		61.7	65.5	66.1	63.1	59.3	56.2	51.6	44.3	-	-	26
29		-	53.1	53.8	53.1	52.7	48.7	45.6	41.9	35.7	-	29
33		-	44.3	45.0	46.5	45.9	43.0	41.2	37.7	34.4	26.5	33
39		-	32.6	34.4	34.6	34.8	34.4	33.7	31.3	29.5	26.2	39
46		-	-	26.9	27.3	27.3	26.7	26.5	26.0	25.1	23.4	46
52		-	-	21.6	22.0	22.0	21.8	21.4	21.4	20.7	19.4	52
59		-	-	18.3	18.3	18.5	18.1	17.4	17.6	16.8	16.1	59
65		-	-	-	15.4	15.7	15.2	14.6	14.8	13.9	13.2	65
72		-	-	-	13.2	13.2	12.8	12.3	12.6	11.7	11.0	72
79		-	-	-	-	11.5	11.0	10.4	10.6	9.7	9.0	79
85		-	-	-	-	9.9	9.3	8.8	9.0	8.2	7.5	85
92		-	-	-	-	-	7.9	7.5	7.5	6.6	6.2	92
98		-	-	-	-	-	6.8	6.2	6.4	5.5	4.9	98
105		-	-	-	-	-	-	5.3	5.5	4.6	4.0	105
111		-	-	-	-	-	-	3.7	4.6	3.7	3.1	111
118		-	-	-	-	-	-	-	3.7	2.9	2.4	118
124		-	-	-	-	-	-	-	2.2	2.2	1.8	124
131		-	-	-	-	-	-	-	-	1.8	-	131

**DEMAG AC100/4**
ALL TERRAIN CRANE**HA**

		15,200 lb		 26.6 ft x 23.6 ft		360°		85 %						
				39.0 ft	53.1 ft	66.9 ft	81.0 ft	95.1 ft	109.3 ft	123.0 ft	132.9 ft	148.3 ft	164.0 ft	
				1,000 lb										
ft														ft
10		160.1	159.8	155.6	128.8	-	-	-	-	-	-	-	-	10
11		145.3	146.4	144.2	128.8	-	-	-	-	-	-	-	-	11
13		132.7	133.8	133.8	121.5	106.0	-	-	-	-	-	-	-	13
15		122.1	123.2	123.0	116.6	102.1	-	-	-	-	-	-	-	15
16		113.1	114.2	114.0	107.4	95.7	76.7	-	-	-	-	-	-	16
19		95.2	95.5	90.8	83.6	75.4	69.9	-	-	-	-	-	-	19
23		71.2	75.4	73.2	67.9	63.5	59.7	54.2	40.1	-	-	-	-	23
26		54.9	58.6	59.3	56.7	55.1	50.5	48.3	44.3	-	-	-	-	26
29		-	47.4	48.3	49.6	47.4	45.2	42.1	39.0	35.7	-	-	-	29
33		-	39.5	41.2	41.7	41.0	39.9	37.9	35.1	32.8	26.5	-	-	33
39		-	28.9	30.6	31.1	31.1	30.4	29.8	29.1	26.9	25.1	-	-	39
46		-	-	24.0	24.3	24.5	24.0	23.4	23.6	21.8	20.3	-	-	46
52		-	-	19.4	19.6	19.6	19.2	18.7	19.0	17.9	16.3	-	-	52
59		-	-	15.9	16.1	16.3	15.7	15.2	15.4	14.6	13.2	-	-	59
65		-	-	-	13.4	13.4	13.0	12.6	12.8	11.9	10.6	-	-	65
72		-	-	-	11.2	11.2	10.8	10.4	10.6	9.5	8.6	-	-	72
79		-	-	-	-	9.5	9.0	8.4	8.6	7.7	7.1	-	-	79
85		-	-	-	-	8.2	7.5	7.1	7.3	6.4	5.7	-	-	85
92		-	-	-	-	-	6.4	5.7	6.0	5.1	4.4	-	-	92
98		-	-	-	-	-	5.3	4.9	4.9	4.0	3.5	-	-	98
105		-	-	-	-	-	-	4.0	4.0	3.1	2.6	-	-	105
111		-	-	-	-	-	-	2.4	3.3	2.4	1.8	-	-	111
118		-	-	-	-	-	-	-	2.6	1.8	-	-	-	118

		11,900 lb		 26.6 ft x 23.6 ft		360°		85 %						
				39.0 ft	53.1 ft	66.9 ft	81.0 ft	95.1 ft	109.3 ft	123.0 ft	132.9 ft	148.3 ft	164.0 ft	
				1,000 lb										
ft														ft
10		159.4	159.8	155.6	128.8	-	-	-	-	-	-	-	-	10
11		144.8	145.9	144.2	128.8	-	-	-	-	-	-	-	-	11
13		132.3	133.4	133.4	121.5	106.0	-	-	-	-	-	-	-	13
15		121.7	123.0	122.8	116.6	102.1	-	-	-	-	-	-	-	15
16		112.7	113.8	110.9	102.1	90.8	76.7	-	-	-	-	-	-	16
19		93.0	92.8	86.4	79.4	71.4	68.3	-	-	-	-	-	-	19
23		67.2	71.4	69.4	64.4	61.9	56.4	52.2	40.1	-	-	-	-	23
26		51.8	55.3	56.2	54.9	52.2	48.3	45.9	41.7	-	-	-	-	26
29		-	44.8	46.7	47.2	45.0	43.2	40.8	37.7	35.3	-	-	-	29
33		-	37.3	39.0	39.5	39.7	37.7	35.7	32.8	32.2	26.5	-	-	33
39		-	27.1	28.9	29.3	29.3	29.1	28.0	27.6	25.4	23.4	-	-	39
46		-	-	22.7	22.9	22.9	22.5	22.0	22.0	20.1	18.5	-	-	46
52		-	-	18.1	18.3	18.5	18.1	17.4	17.6	16.3	15.0	-	-	52
59		-	-	14.8	15.0	15.0	14.6	14.1	14.3	13.2	11.9	-	-	59
65		-	-	-	12.3	12.6	11.9	11.5	11.7	10.6	9.5	-	-	65
72		-	-	-	10.4	10.4	9.9	9.3	9.5	8.6	7.5	-	-	72
79		-	-	-	-	8.8	8.2	7.5	7.7	6.8	6.0	-	-	79
85		-	-	-	-	7.3	6.8	6.2	6.4	5.5	4.9	-	-	85
92		-	-	-	-	-	5.7	5.1	5.3	4.4	3.7	-	-	92
98		-	-	-	-	-	4.6	4.2	4.2	3.3	2.9	-	-	98
105		-	-	-	-	-	-	3.3	3.3	2.4	2.0	-	-	105
111		-	-	-	-	-	-	2.0	2.6	1.8	-	-	-	111
118		-	-	-	-	-	-	-	2.0	-	-	-	-	118



HAV

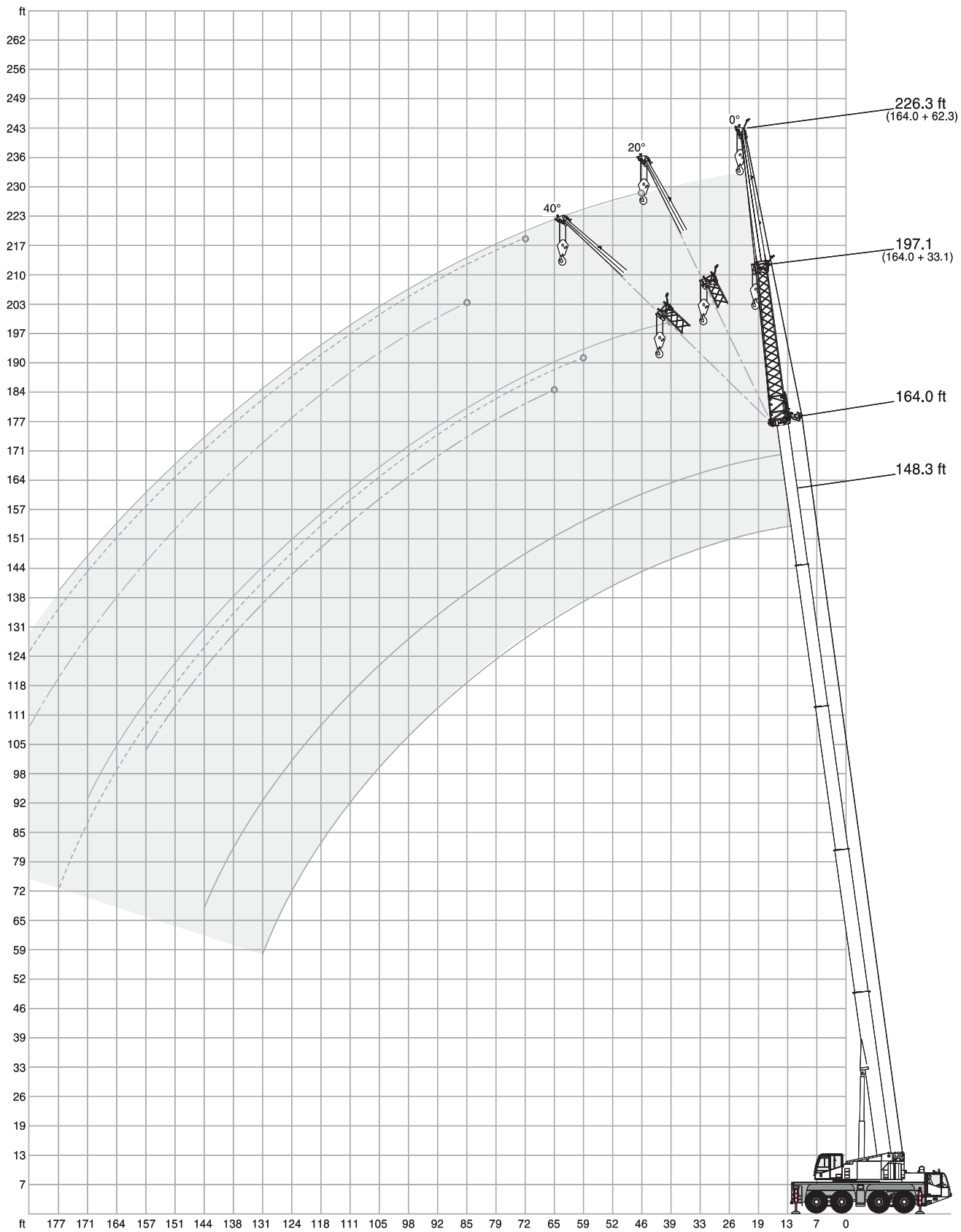

**DEMAG AC100/4**
ALL TERRAIN CRANE**HAV**57,500 lb  26.6 ft x 23.6 ft 360° 85 %

148.3 ft							
ft	33.1 ft			62.3 ft			1,000 lb
	0°	20°	40°	0°	20°	40°	
39	19.0	-	-	10.1	-	-	
46	18.7	-	-	10.1	-	-	
52	18.5	18.1	-	10.1	-	-	
59	18.1	17.4	15.9	10.1	-	-	
65	17.0	16.5	15.7	9.9	9.3	-	
72	15.9	15.7	15.4	9.7	9.0	-	
79	14.8	14.8	14.8	9.5	8.8	7.7	
85	13.7	13.9	13.9	9.3	8.6	7.5	
92	12.8	12.8	13.0	9.0	8.4	7.5	
98	11.2	12.1	12.1	8.8	8.2	7.3	
105	9.9	10.6	11.2	8.6	8.2	7.3	
111	9.3	9.3	9.7	8.2	7.9	7.1	
118	8.2	8.6	8.8	7.9	7.7	7.1	
124	7.1	7.7	7.9	7.1	7.3	6.8	
131	6.2	6.6	6.8	6.6	7.1	6.8	
138	5.5	6.0	6.0	5.7	6.2	6.6	
144	4.9	5.1	5.3	5.1	5.7	6.0	
151	4.2	4.4	-	4.4	5.1	5.5	
157	3.5	3.7	-	3.7	4.4	4.9	
164	3.1	3.3	-	3.3	3.7	4.2	
170	-	-	-	2.9	3.3	3.5	
177	-	-	-	2.4	2.9	-	
184	-	-	-	2.0	2.4	-	
190	-	-	-	1.5	1.8	-	
197	-	-	-	-	-	-	

164.0 ft							
ft	33.1 ft			62.3 ft			1,000 lb
	0°	20°	40°	0°	20°	40°	
39	14.8	-	-	-	-	-	
46	14.8	-	-	8.2	-	-	
52	14.8	-	-	8.2	-	-	
59	14.8	14.8	-	8.2	-	-	
65	14.8	14.1	13.0	8.2	-	-	
72	13.9	13.4	12.6	8.2	8.2	-	
79	13.0	12.8	11.9	8.2	8.2	-	
85	12.3	12.1	11.5	8.2	7.9	7.3	
92	11.5	11.5	11.0	8.2	7.9	7.1	
98	10.8	10.8	10.6	8.2	7.7	7.1	
105	9.7	10.4	10.1	7.9	7.5	6.8	
111	8.4	9.3	9.7	7.7	7.1	6.6	
118	7.3	7.9	8.4	7.3	6.8	6.4	
124	6.4	7.1	7.3	6.6	6.6	6.2	
131	5.5	6.0	6.4	5.7	6.2	6.0	
138	4.6	5.3	5.5	5.1	6.0	6.0	
144	4.0	4.4	4.6	4.4	5.3	5.7	
151	3.5	3.7	4.0	3.7	4.4	5.1	
157	2.9	3.1	3.3	3.1	3.7	4.4	
164	2.4	2.6	-	2.6	3.3	3.7	
170	2.0	2.2	-	2.2	2.6	3.1	
177	-	1.5	-	1.5	2.2	2.4	
184	-	-	-	-	1.8	2.0	
190	-	-	-	-	-	-	
197	-	-	-	-	-	-	

47,000 lb (47,200 lb)  26.6 ft x 23.6 ft 360° 85 %

148.3 ft							
ft	33.1 ft			62.3 ft			1,000 lb
	0°	20°	40°	0°	20°	40°	
39	19.0	-	-	10.1	-	-	
46	18.7	-	-	10.1	-	-	
52	18.5	18.1	-	10.1	-	-	
59	18.1	17.4	15.9	10.1	-	-	
65	17.0	16.5	15.7	9.9	9.3	-	
72	15.9	15.7	15.4	9.7	9.0	-	
79	14.6	14.8	14.8	9.5	8.8	7.7	
85	12.6	13.4	13.9	9.3	8.6	7.5	
92	11.5	11.7	12.3	9.0	8.4	7.5	
98	9.9	10.6	10.8	8.8	8.2	7.3	
105	8.6	9.3	9.7	8.4	8.2	7.3	
111	7.5	8.2	8.6	7.7	7.9	7.1	
118	6.4	7.1	7.3	6.8	7.5	7.1	
124	5.5	6.0	6.4	6.0	6.6	6.8	
131	4.9	5.3	5.5	5.1	6.0	6.4	
138	4.0	4.4	4.6	4.4	5.3	5.7	
144	3.5	3.7	4.0	3.7	4.4	5.1	
151	2.9	3.1	-	3.1	3.7	4.2	
157	2.4	2.6	-	2.6	3.3	3.5	
164	2.0	2.0	-	2.2	2.6	3.1	
170	-	-	-	1.8	2.2	2.4	
177	-	-	-	-	1.8	-	
184	-	-	-	-	-	-	

164.0 ft							
ft	33.1 ft			62.3 ft			1,000 lb
	0°	20°	40°	0°	20°	40°	
39	14.8	-	-	-	-	-	
46	14.8	-	-	8.2	-	-	
52	14.8	-	-	8.2	-	-	
59	14.8	14.8	-	8.2	-	-	
65	14.8	14.1	13.0	8.2	-	-	
72	13.9	13.4	12.6	8.2	8.2	-	
79	13.0	12.8	11.9	8.2	8.2	-	
85	12.3	12.1	11.5	8.2	7.9	7.3	
92	10.6	11.5	11.0	8.2	7.9	7.1	
98	9.0	9.9	10.6	8.2	7.7	7.1	
105	7.7	8.6	9.3	7.9	7.5	6.8	
111	6.6	7.5	7.9	6.8	7.1	6.6	
118	5.7	6.4	6.8	6.0	6.8	6.4	
124	4.9	5.5	5.7	5.1	6.2	6.2	
131	4.0	4.6	4.9	4.4	5.3	6.0	
138	3.3	3.7	4.2	3.5	4.6	5.3	
144	2.6	3.1	3.3	3.1	4.0	4.6	
151	2.2	2.4	2.6	2.4	3.3	3.7	
157	1.5	2.0	2.0	2.0	2.6	3.1	
164	-	-	-	-	2.0	2.4	
170	-	-	-	-	1.5	2.0	
177	-	-	-	-	-	-	
184	-	-	-	-	-	-	

**HAV**

22,300 lb	26.6 ft x 23.6 ft	360°	85 %
------------------	--------------------------	-------------	-------------

148.3 ft							
ft	33.1 ft			62.3 ft			1,000 lb
	0°	20°	40°	0°	20°	40°	
39	19.0	-	-	10.1	-	-	
46	18.7	-	-	10.1	-	-	
52	18.3	18.1	-	10.1	-	-	
59	16.1	16.8	15.9	10.1	-	-	
65	13.4	14.1	15.4	9.9	9.3	-	
72	11.2	12.3	13.0	9.7	9.0	-	
79	9.3	10.4	11.5	9.0	8.8	7.7	
85	7.7	8.8	9.7	7.5	8.6	7.5	
92	6.4	7.3	8.2	6.4	7.9	7.5	
98	5.3	6.2	6.6	5.3	6.8	7.3	
105	4.2	5.1	5.5	4.4	5.7	6.8	
111	3.3	4.0	4.4	3.5	4.9	6.0	
118	2.6	3.1	3.5	2.9	4.0	5.1	
124	2.0	2.4	2.9	2.2	3.3	4.2	
131	-	1.8	2.0	1.8	2.6	3.3	
138	-	-	-	-	2.0	2.6	
144	-	-	-	-	-	2.0	



164.0 ft							
ft	33.1 ft			62.3 ft			1,000 lb
	0°	20°	40°	0°	20°	40°	
39	14.8	-	-	-	-	-	
46	14.8	-	-	8.2	-	-	
52	14.8	-	-	8.2	-	-	
59	14.6	14.8	-	8.2	-	-	
65	11.9	13.4	13.0	8.2	-	-	
72	9.7	11.2	12.3	8.2	8.2	-	
79	7.9	9.3	10.4	7.7	8.2	-	
85	6.4	7.7	8.6	6.2	7.9	7.3	
92	5.3	6.2	7.1	5.1	6.8	7.1	
98	4.2	5.1	6.0	4.0	5.7	7.1	
105	3.3	4.2	4.9	3.1	4.6	6.2	
111	2.4	3.3	3.7	2.4	3.7	5.1	
118	1.8	2.4	3.1	1.8	3.1	4.2	
124	-	1.8	2.2	-	2.2	3.3	
131	-	-	-	-	1.8	2.6	
138	-	-	-	-	-	2.0	
144	-	-	-	-	-	-	



11,900 lb	26.6 ft x 23.6 ft	360°	85 %
------------------	--------------------------	-------------	-------------

148.3 ft							
ft	33.1 ft			62.3 ft			1,000 lb
	0°	20°	40°	0°	20°	40°	
39	19.0	-	-	10.1	-	-	
46	17.6	-	-	10.1	-	-	
52	15.0	16.1	-	10.1	-	-	
59	12.1	13.9	14.6	10.1	-	-	
65	9.7	11.2	12.6	9.5	9.3	-	
72	7.7	9.0	10.1	7.5	9.0	-	
79	6.2	7.3	8.4	6.0	8.2	7.7	
85	4.9	6.0	6.8	4.9	6.6	7.5	
92	4.0	4.9	5.5	3.7	5.5	7.1	
98	3.1	3.7	4.4	2.9	4.4	5.7	
105	2.2	2.9	3.5	2.0	3.5	4.6	
111	-	2.2	2.6	-	2.6	3.7	
118	-	-	1.8	-	2.0	3.1	
124	-	-	-	-	-	2.2	
131	-	-	-	-	-	1.8	



164.0 ft							
ft	33.1 ft			62.3 ft			1,000 lb
	0°	20°	40°	0°	20°	40°	
39	14.8	-	-	-	-	-	
46	14.8	-	-	8.2	-	-	
52	13.4	-	-	8.2	-	-	
59	10.6	12.3	-	8.2	-	-	
65	8.2	9.9	11.2	7.9	-	-	
72	6.4	7.7	9.0	6.2	8.2	-	
79	4.9	6.2	7.3	4.6	7.1	-	
85	3.7	4.9	5.7	3.5	5.5	7.3	
92	2.6	3.7	4.6	2.4	4.4	6.2	
98	1.8	2.6	3.5	1.5	3.3	4.9	
105	-	2.0	2.6	-	2.4	4.0	
111	-	-	1.8	-	1.8	2.9	
118	-	-	-	-	-	2.2	
124	-	-	-	-	-	-	
131	-	-	-	-	-	-	



**DEMAG AC100/4**
ALL TERRAIN CRANE**HAV-VA**57,500 lb  26.6 ft x 23.6 ft 360° 85 %

 148.3 ft		26.2 ft				
		0°	0°	0°	20°	40°
 		62.3 ft				
		0°	20°	40°	0°	0°
ft	1,000 lb					
46	6.6	-	-	-	-	
52	6.6	-	-	-	-	
59	6.6	-	-	-	-	
65	6.6	-	-	-	-	
72	6.6	6.4	-	-	-	
79	6.6	6.2	-	-	-	
85	6.4	6.2	-	5.5	-	
92	6.2	6.0	5.5	5.3	-	
98	6.0	5.7	5.5	5.1	-	
105	5.7	5.5	5.3	4.9	4.2	
111	5.7	5.3	5.1	4.9	4.0	
118	5.5	5.1	5.1	4.6	4.0	
124	5.3	4.9	4.9	4.4	4.0	
131	5.1	4.9	4.6	4.4	3.7	
138	4.9	4.6	4.6	4.2	3.7	
144	4.0	4.4	4.4	4.2	3.7	
151	3.7	4.2	4.4	4.0	3.5	
157	3.3	3.5	4.2	4.0	3.5	
164	2.6	3.3	3.5	3.3	3.5	
170	2.0	2.9	3.1	2.9	3.3	
177	1.5	2.2	2.6	2.4	2.9	
184	-	1.8	2.0	2.0	2.4	
190	-	-	-	-	1.8	

 164.0 ft		26.2 ft				
		0°	0°	0°	20°	40°
 		62.3 ft				
		0°	20°	40°	0°	0°
ft	1,000 lb					
46	-	-	-	-	-	
52	4.9	-	-	-	-	
59	4.9	-	-	-	-	
65	4.9	-	-	-	-	
72	4.9	-	-	-	-	
79	4.9	4.6	-	-	-	
85	4.9	4.6	-	-	-	
92	4.9	4.6	-	4.6	-	
98	4.9	4.6	4.9	4.6	-	
105	4.9	4.6	4.9	4.6	-	
111	4.9	4.6	4.6	4.4	4.0*	
118	4.9	4.4	4.6	4.4	3.7*	
124	4.9	4.4	4.4	4.2	3.7*	
131	4.6	4.2	4.2	4.0	3.7*	
138	4.2	4.0	4.0	3.7	3.5*	
144	3.7	4.0	4.0	3.7	3.3*	
151	3.1	3.7	3.7	3.5	3.3*	
157	2.4	3.3	3.5	3.3	3.1*	
164	1.8	2.6	3.3	3.1	3.1*	
170	-	2.2	2.6	2.4	3.1*	
177	-	-	2.0	1.8	2.6*	
184	-	-	-	-	2.0*	
190	-	-	-	-	-	

47,000 lb (47,200 lb)  26.6 ft x 23.6 ft 360° 85 %

 148.3 ft		26.2 ft				
		0°	0°	0°	20°	40°
 		62.3 ft				
		0°	20°	40°	0°	0°
ft	1,000 lb					
46	6.6	-	-	-	-	
52	6.6	-	-	-	-	
59	6.6	-	-	-	-	
65	6.6	-	-	-	-	
72	6.6	6.4	-	-	-	
79	6.6	6.2	-	-	-	
85	6.4	6.2	-	5.5	-	
92	6.2	6.0	5.5	5.3	-	
98	6.0	5.7	5.5	5.1	-	
105	5.7	5.5	5.5	4.9	4.2	
111	5.7	5.3	5.1	4.9	4.0	
118	5.5	5.1	5.1	4.6	4.0	
124	4.9	4.9	4.9	4.4	4.0	
131	4.6	4.9	4.6	4.4	3.7	
138	3.7	4.4	4.6	4.2	3.7	
144	3.1	4.0	4.4	4.0	3.7	
151	2.4	3.3	3.7	3.5	3.5	
157	2.0	2.6	3.3	3.1	3.5	
164	-	2.2	2.6	2.4	3.1	
170	-	1.5	2.0	1.8	2.6	
177	-	-	-	-	2.0	

 164.0 ft		26.2 ft				
		0°	0°	0°	20°	40°
 		62.3 ft				
		0°	20°	40°	0°	0°
ft	1,000 lb					
46	-	-	-	-	-	
52	4.9	-	-	-	-	
59	4.9	-	-	-	-	
65	4.9	-	-	-	-	
72	4.9	-	-	-	-	
79	4.9	4.6	-	-	-	
85	4.9	4.6	-	-	-	
92	4.9	4.6	-	4.6	-	
98	4.9	4.6	4.9	4.6	-	
105	4.9	4.6	4.9	4.6	-	
111	4.9	4.6	4.6	4.4	4.0*	
118	4.9	4.4	4.6	4.4	3.7*	
124	4.2	4.4	4.4	4.2	3.7*	
131	3.3	4.2	4.2	4.0	3.7*	
138	2.6	4.0	4.0	3.7	3.5*	
144	2.0	3.1	4.0	3.5	3.3*	
151	-	2.4	3.5	2.9	3.3*	
157	-	2.0	2.9	2.2	3.1*	
164	-	-	2.2	1.8	2.9*	
170	-	-	-	-	2.2*	
177	-	-	-	-	-	

*  160.8 ft



HAV-VA

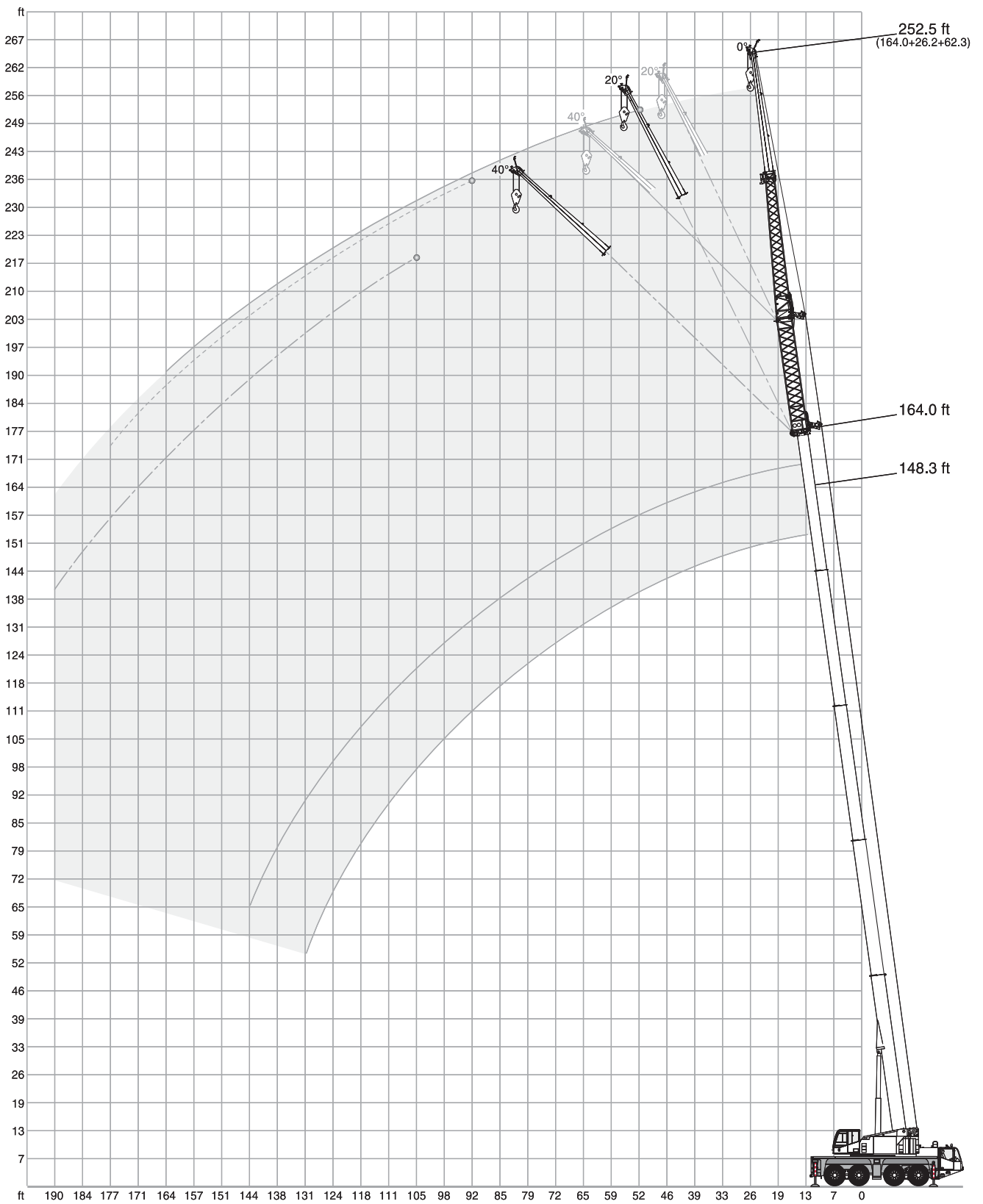

**DEMAG AC100/4**
ALL TERRAIN CRANE**MS**



57,500 lb	26.6 ft x 23.6 ft	360°	85 %
-----------	-------------------	------	------

			39.0 ft	53.1 ft	66.9 ft	81.0 ft	95.1 ft	109.3 ft	123.0 ft	132.9 ft	148.3 ft	164.0 ft	
ft	1,000 lb												ft
10	58.0	58.0	58.0	-	-	-	-	-	-	-	-	-	10
11	58.0	58.0	58.0	58.0	-	-	-	-	-	-	-	-	11
13	58.0	58.0	58.0	58.0	-	-	-	-	-	-	-	-	13
15	58.0	58.0	58.0	58.0	-	-	-	-	-	-	-	-	15
16	58.0	58.0	58.0	58.0	58.0	-	-	-	-	-	-	-	16
19	58.0	58.0	58.0	58.0	58.0	58.0	58.0	-	-	-	-	-	19
23	58.0	58.0	58.0	58.0	58.0	58.0	58.0	-	-	-	-	-	23
26	58.0	58.0	58.0	58.0	58.0	58.0	55.3	48.1	35.1	-	-	-	26
29	58.0	58.0	58.0	58.0	58.0	56.9	52.0	45.2	38.8	-	-	-	29
33	58.0	58.0	58.0	58.0	55.3	48.7	42.5	36.8	32.2	-	-	-	33
39	-	53.8	55.1	54.7	52.2	42.8	37.9	33.3	29.8	23.6	-	-	39
46	-	44.8	45.6	45.2	43.9	37.7	34.0	30.2	27.1	22.9	-	-	46
52	-	-	37.3	36.8	35.5	35.1	29.8	27.3	24.9	21.6	-	-	52
59	-	-	31.3	30.9	29.5	30.4	27.1	24.5	22.9	20.1	-	-	59
65	-	-	-	26.0	26.9	25.8	24.7	22.3	20.7	18.5	-	-	65
72	-	-	-	22.5	23.1	22.0	22.3	20.5	19.2	17.0	-	-	72
79	-	-	-	-	20.3	19.2	19.4	18.7	17.6	15.7	-	-	79
85	-	-	-	-	17.9	17.6	17.0	16.5	16.1	14.8	-	-	85
92	-	-	-	-	12.1	15.9	14.8	14.6	13.9	13.7	-	-	92
98	-	-	-	-	-	14.1	13.7	12.8	12.8	12.1	-	-	98
105	-	-	-	-	-	11.7	12.1	11.0	11.2	10.4	-	-	105
111	-	-	-	-	-	-	10.8	10.6	9.9	9.0	-	-	111
118	-	-	-	-	-	-	-	9.7	8.6	7.9	-	-	118
124	-	-	-	-	-	-	-	8.6	7.5	6.8	-	-	124
131	-	-	-	-	-	-	-	-	6.6	6.0	-	-	131
138	-	-	-	-	-	-	-	-	6.0	5.1	-	-	138
144	-	-	-	-	-	-	-	-	-	4.4	-	-	144
151	-	-	-	-	-	-	-	-	-	3.7	-	-	151
157	-	-	-	-	-	-	-	-	-	-	-	-	157





MS

 47,000 lb
  26.6 ft x 23.6 ft
  360°
  85 %

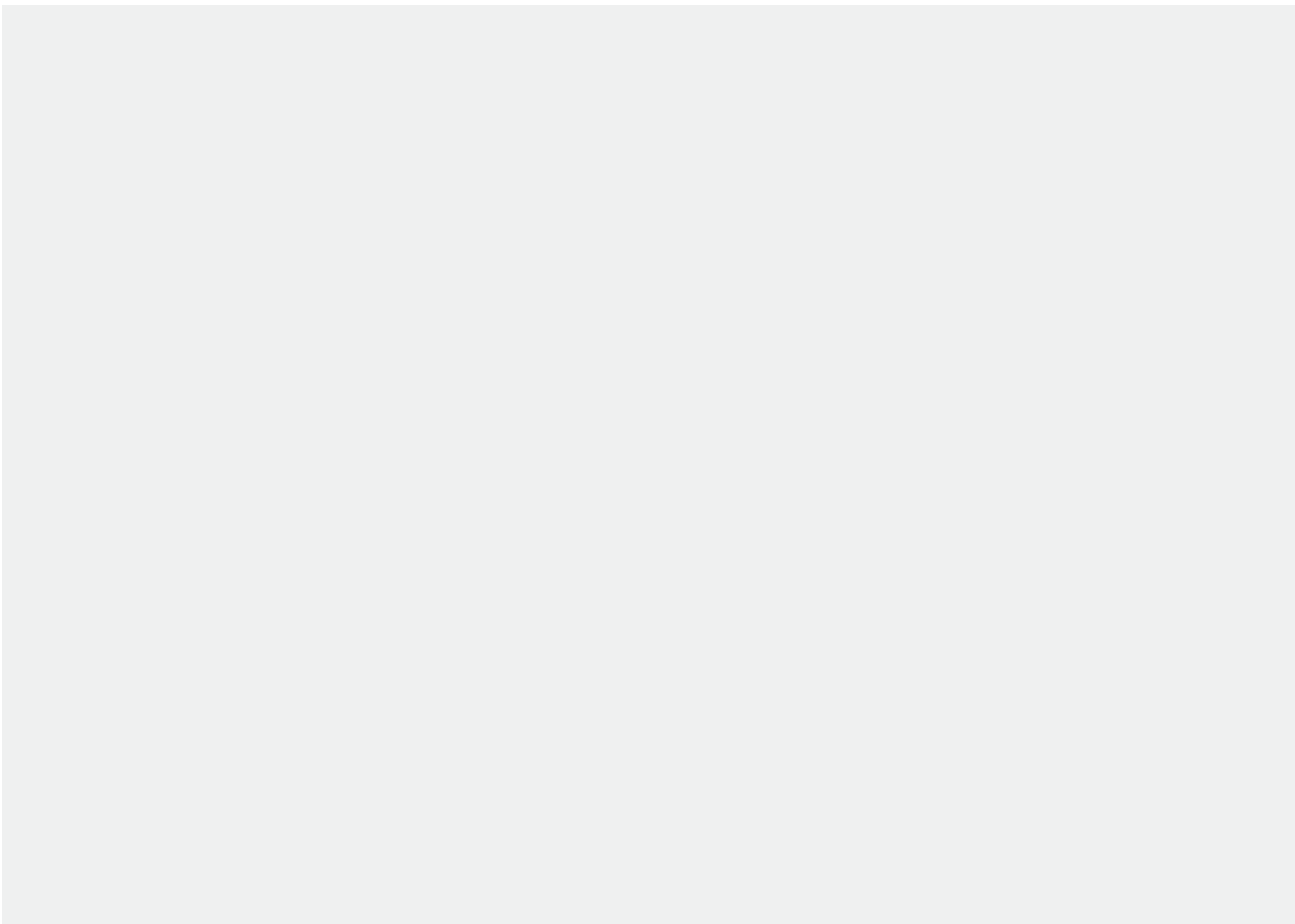

			39.0 ft	53.1 ft	66.9 ft	81.0 ft	95.1 ft	109.3 ft	123.0 ft	132.9 ft	148.3 ft	164.0 ft	
ft	1,000 lb												ft
10	58.0	58.0	58.0	-	-	-	-	-	-	-	-	-	10
11	58.0	58.0	58.0	58.0	-	-	-	-	-	-	-	-	11
13	58.0	58.0	58.0	58.0	-	-	-	-	-	-	-	-	13
15	58.0	58.0	58.0	58.0	-	-	-	-	-	-	-	-	15
16	58.0	58.0	58.0	58.0	58.0	-	-	-	-	-	-	-	16
19	58.0	58.0	58.0	58.0	58.0	58.0	58.0	-	-	-	-	-	19
23	58.0	58.0	58.0	58.0	58.0	58.0	58.0	-	-	-	-	-	23
26	58.0	58.0	58.0	58.0	58.0	58.0	55.3	48.1	35.1	-	-	-	26
29	58.0	58.0	58.0	58.0	58.0	56.9	52.0	45.2	38.8	-	-	-	29
33	58.0	58.0	58.0	58.0	55.3	48.7	42.5	36.8	32.2	-	-	-	33
39	-	49.8	51.6	50.9	49.6	42.8	37.9	33.3	29.8	23.6	-	-	39
46	-	40.1	40.6	40.1	38.8	37.7	34.0	30.2	27.1	22.9	-	-	46
52	-	-	33.1	32.4	32.2	32.2	29.8	27.3	24.9	21.6	-	-	52
59	-	-	27.6	26.9	27.8	26.7	26.7	24.5	22.9	20.1	-	-	59
65	-	-	-	24.0	23.6	22.7	22.7	21.8	20.7	18.5	-	-	65
72	-	-	-	20.7	20.3	20.3	19.4	19.0	18.5	17.0	-	-	72
79	-	-	-	-	17.6	17.6	17.2	16.3	15.9	15.7	-	-	79
85	-	-	-	-	15.9	15.4	15.0	14.1	14.3	13.4	-	-	85
92	-	-	-	-	12.1	13.7	13.2	13.0	12.3	11.5	-	-	92
98	-	-	-	-	-	12.1	11.5	11.5	10.6	9.7	-	-	98
105	-	-	-	-	-	10.6	10.1	10.1	9.3	8.4	-	-	105
111	-	-	-	-	-	-	8.8	8.8	7.9	7.1	-	-	111
118	-	-	-	-	-	-	-	7.7	6.8	6.0	-	-	118
124	-	-	-	-	-	-	-	6.8	6.0	5.1	-	-	124
131	-	-	-	-	-	-	-	-	5.1	4.2	-	-	131
138	-	-	-	-	-	-	-	-	4.4	3.5	-	-	138
144	-	-	-	-	-	-	-	-	-	2.9	-	-	144
151	-	-	-	-	-	-	-	-	-	2.2	-	-	151
157	-	-	-	-	-	-	-	-	-	-	-	-	157



**DEMAG AC100/4**
ALL TERRAIN CRANE**MS**15,200 lb  26.6 ft x 23.6 ft 360° 85 %

			39.0 ft	53.1 ft	66.9 ft	81.0 ft	95.1 ft	109.3 ft	123.0 ft	132.9 ft	148.3 ft	164.0 ft	
ft	1,000 lb												ft
10			58.0	58.0	58.0	-	-	-	-	-	-	-	10
11			58.0	58.0	58.0	58.0	-	-	-	-	-	-	11
13			58.0	58.0	58.0	58.0	-	-	-	-	-	-	13
15			58.0	58.0	58.0	58.0	-	-	-	-	-	-	15
16			58.0	58.0	58.0	58.0	58.0	-	-	-	-	-	16
19			58.0	58.0	58.0	58.0	58.0	58.0	-	-	-	-	19
23			58.0	58.0	58.0	58.0	58.0	58.0	-	-	-	-	23
26			58.0	58.0	58.0	58.0	56.7	53.6	48.1	35.1	-	-	26
29			50.5	53.6	54.2	52.9	49.8	47.4	43.0	38.8	-	-	29
33			41.7	44.5	45.2	44.5	45.0	41.2	39.0	36.2	32.2	-	33
39			-	32.6	34.2	34.2	33.5	33.7	31.5	29.5	27.8	23.6	39
46			-	25.1	26.5	26.7	26.7	26.0	25.6	24.7	23.4	21.4	46
52			-	-	21.2	21.4	21.4	20.9	20.5	20.5	19.0	17.2	52
59			-	-	17.4	17.6	17.6	17.2	16.5	16.5	15.4	13.9	59
65			-	-	-	14.6	14.6	14.1	13.4	13.7	12.6	11.0	65
72			-	-	-	12.1	12.1	11.7	11.0	11.0	10.1	8.8	72
79			-	-	-	-	10.1	9.7	9.0	9.0	7.9	6.8	79
85			-	-	-	-	8.6	7.9	7.3	7.3	6.4	5.3	85
92			-	-	-	-	7.1	6.6	6.0	6.0	5.1	4.2	92
98			-	-	-	-	-	5.3	4.9	4.9	4.0	3.1	98
105			-	-	-	-	-	4.4	3.7	3.7	2.9	2.0	105
111			-	-	-	-	-	-	2.9	3.1	2.0	-	111
118			-	-	-	-	-	-	-	2.2	-	-	118
124			-	-	-	-	-	-	-	1.5	-	-	124
131			-	-	-	-	-	-	-	-	-	-	131

11,900 lb  26.6 ft x 23.6 ft 360° 85 %

			39.0 ft	53.1 ft	66.9 ft	81.0 ft	95.1 ft	109.3 ft	123.0 ft	132.9 ft	148.3 ft	164.0 ft	
ft	1,000 lb												ft
10			58.0	58.0	58.0	-	-	-	-	-	-	-	10
11			58.0	58.0	58.0	58.0	-	-	-	-	-	-	11
13			58.0	58.0	58.0	58.0	-	-	-	-	-	-	13
15			58.0	58.0	58.0	58.0	-	-	-	-	-	-	15
16			58.0	58.0	58.0	58.0	58.0	-	-	-	-	-	16
19			58.0	58.0	58.0	58.0	58.0	58.0	-	-	-	-	19
23			58.0	58.0	58.0	58.0	58.0	58.0	-	-	-	-	23
26			58.0	58.0	58.0	58.0	53.8	52.0	47.4	35.1	-	-	26
29			47.6	50.7	51.4	50.0	48.1	44.8	41.7	38.8	-	-	29
33			39.2	42.1	42.8	42.5	42.5	39.5	37.5	34.4	32.2	-	33
39			-	30.6	32.2	32.4	32.0	31.7	30.2	27.6	26.5	23.6	39
46			-	23.6	24.9	25.1	25.1	24.5	24.0	23.6	21.6	19.6	46
52			-	-	19.8	20.1	20.3	19.6	19.2	19.2	17.2	15.7	52
59			-	-	16.3	16.3	16.3	15.9	15.2	15.4	13.9	12.3	59
65			-	-	-	13.4	13.4	13.0	12.3	12.3	11.2	9.7	65
72			-	-	-	11.0	11.2	10.6	9.9	9.9	9.0	7.5	72
79			-	-	-	-	9.3	8.6	7.9	8.2	7.1	5.7	79
85			-	-	-	-	7.7	7.1	6.4	6.4	5.5	4.4	85
92			-	-	-	-	6.4	5.7	5.1	5.1	4.2	3.3	92
98			-	-	-	-	-	4.6	4.0	4.2	3.1	2.2	98
105			-	-	-	-	-	3.7	3.1	3.1	2.2	-	105
111			-	-	-	-	-	-	2.2	2.4	-	-	111
118			-	-	-	-	-	-	-	1.5	-	-	118

**EQUIPMENT****CARRIER**

Outriggers	Vertical and horizontal movement fully hydraulic; manual or automatic leveling alternatively; may be operated from crane cab or from either side of the carrier; 4 outrigger bases.
Engine	DaimlerChrysler; output: 335 kW (455 hp); max. torque 2000 Nm. Certifications in accordance with EURO MOT 3a, TIER 3 and CARB. Fuel tank: 106 gallons diesel fuel.
Transmission	ZF AS-Tronic, automatic transmission with integrated retarder; 12 forward speeds and 2 reverse speeds, 2-stage transfer case with offroad-gear and selectable longitudinal differential lock.
Axles	8 x 6 x 8. Four axles, axles 1, 2 and 4 are driven and dispose of selectable transverse lock. Axles 1, 2, 3 and 4 steered.
Suspension	Hydropneumatic suspension with axle load compensation, hydraulically lockable. Manual or automatic leveling alternatively; spring travel: +5,1" / -4,3".
Steering	Dual circuit hydro semiblock steering with emergency steering pump; rear axle steering with six different driving programs.
Brakes	Pneumatic dual circuit service brake with anti lock braking system (ABS), acting on all wheels; hydraulic retarder integrated into transmission as sustained-action brake; additional exhaust brake and constant throttle valve.
Tires	14.00 R 25.
Driver's cab	Two adjustable seats with seat heating, armrests and pneumatic suspension; steering wheel height and tilt adjustable; power windows; radio with CD player; tinted safety glass; engine-dependent water heating; air-condition.
Stowage compartments	Open storage boxes for lifting hooks and lifting tackle; lockable compartments on undercarriage side.
Miscellaneous, carrier	External starting installation for carrier / superstructure; two rotating beacons on driver's cab; illumination for outriggers.

SUPERSTRUCTURE

Telescopic boom	39.0 ft – 164.0 ft. Single cylinder telescoping system; manual or automatic telescoping alternatively. Attachments for all optional equipment; 5 sheaves in boom head for max. lifting capacity of 142,400 lb.
Counterweight	47,000 lb, 6 sections. Automatic rigging system, expandable to 57,500 lb max. The machine may transport 47,000 lb while maintaining vehicle width.
Boom elevation	1 luffing cylinder with automatic lowering brake valve.
Slew unit	1 slewing gear with spring-loaded multi-disc brake; four different operating modes selectable.
Hoist	1 lifting unit with spring-loaded multi-disc brake; integrated rotation indicator.
Engine	DaimlerChrysler; output: 129 kW (175 hp); max. torque 630 Nm. Certifications in accordance with EURO MOT 3a, TIER 3 and CARB.
Drive	Hydraulic system with power control; axial-piston dual pump and two separate pumps for slewing unit and auxiliary consuming devices; hydraulic oil cooler.
Control system	Pump control for four simultaneous working movements; electrical pilot controls via two four-way control levers; different control modes selectable for hydraulic circuits; individual operator settings may be stored.
Operator aids	Demag IC-1 with integrated electronic load moment limiter; color display; current operating conditions displayed; load charts, outrigger loads, working range limiter; fault indicator; acoustical and optical pre-warning when approaching limit switches and limit conditions; anemometer.
Crane cab	Tilt infinitely variable tilt up to 20°. Seat heating, sliding window in sliding door and rear; fold-out windscreen; extendable side platform; foldable front platform; tinted safety-glass; pull-down sun visor; radio with CD player; engine dependent and engine-independent warm water heating with timer; air-condition.
Miscellaneous, superstructure	Illumination for hoist, work area and engine compartment; two rotating beacons at the rear; guard-rail.

OPTIONAL EQUIPMENT

HAV	33.1 ft / 62.3 ft; double folding swing-away jib; manually offsettable by 20° / 40°; including transport position. Operation on HA or HAV-VA.
HAV-HY	33.1 ft / 62.3 ft; double folding swing-away jib; infinitely hydraulically offsettable; including transport position. Operation on HA or HAV-VA.
HAV-VA	26.2 ft; variable extension with swing-away jib; manually offsettable by 20° / 40°.
MS	4.9 ft; 2-roll runner; lifting capacity max. 58,700 lb. Operation on HA or HAV-VA, including transport position.
Laterally foldable rooster sheave	Enables maximum hook height at HA, including transport position.
H2	Hoist 2 with spring-loaded multi-disc brake; integrated rotation indicator, self-rigging possible, including transport position
Additional counterweight	10,600 lb; 2 sections, for a total of 57,500 lb.
Counterweight NEG	Version for countries with axle loads below 26,500 lb. 47,000 lb, 7 sections, automatic rigging system, expandable to 57,500 lb max.
Additional counterweight NEG	10,400 lb; 1 section, for a total of 57,500 lb.
Drive	8 x 8 x 8. Axle 3 driven additionally.
Tires	16.00 R 25, 17.50 R 25, 20.50 R 25 (vehicle width 9.5 ft).
Rear view camera	Display in driver's cab.
Back up radar	Acoustical and optical proximity warning in driver's cab.
Additional fuel tank	90 gallons; for carrier.
Remote control	Control of machine via wireless remote control.
Fold-away bed	In driver's cab.
Refinery package	Quick-shutdown installation for engine using air shutoff flap.
Emergency operation	Interface for emergency operation to recover loads when machine has failed; transformer optional.
Xenon-working floodlight	Xenon floodlights, adjustable from crane cabin at front bearing of boom base.
Storage box	Open storage box at the rear.
Toolbox	Large, lockable box at rear (not in combination with trailer couplings).
Trailer couplings	On request.
Gas heater	Trumatic, for crane cabin.
Stowing area for hook blocks	Behind driver's cab; for storage of 1-sheave or 3-sheaves hook block.
Position warning light	Dual obstacle beacon, red. Operation on main boom and all extensions.

Further optional equipment on request!



KEY

-  Counterweight
-  Lifting capacities on outriggers – 360°
-  Radius
-  Main boom
-  Swing-away jib
-  Variable extension
-  Axle loads
-  Mechanism
-  Tires
-  Hook block
-  Hoist
-  Dolly
-  Travel speed
-  Gradeability – road
-  Gradeability – off road
-  Slewing
-  Boom telescoping
-  Boom elevation
-  Workings speeds
-  Max. line pull
-  Rope diameter
-  Rope length
-  Number of sheaves
-  Number of lines
-  Possible load of hook block
-  Weight of hook block
-  Distance head sheave axle – hook ground
-  Number of sheaves in boom head





NOTES TO LIFTING CAPACITY

Ratings are in compliance with ISO 4305.
Lifting capacities do not exceed 85% of tipping load.

Weight of hook blocks and slings is part of the load, and is to be deducted from the capacity ratings.
Consult operation manual for further details.

Note: Data published herein is intended as a guide only and shall not be construed to warrant applicability for lifting purposes.
Crane operation is subject to the computer charts and operation manual both supplied with the crane.

DISCLAIMER

Effective Date: March 2008.

Product specifications and prices are subject to change without notice or obligation. The photographs and/or drawings in this document are for illustrative purposes only. Refer to the appropriate Operator's Manual for instructions on the proper use of this equipment. Failure to follow the appropriate Operator's Manual when using our equipment or to otherwise act irresponsibly may result in serious injury or death. The only warranty applicable to our equipment is the standard written warranty applicable to the particular product and sale and Terex makes no other warranty, express or implied. Products and services listed may be trademarks, service marks or trade-names of Terex Corporation and/or its subsidiaries in the USA and other countries and all rights are reserved. „TEREX“ is a registered trademark of Terex Corporation in the USA and many other countries.

Copyright © 2008 Terex Corporation.



DEMAG AC100/4
ALL TERRAIN CRANE

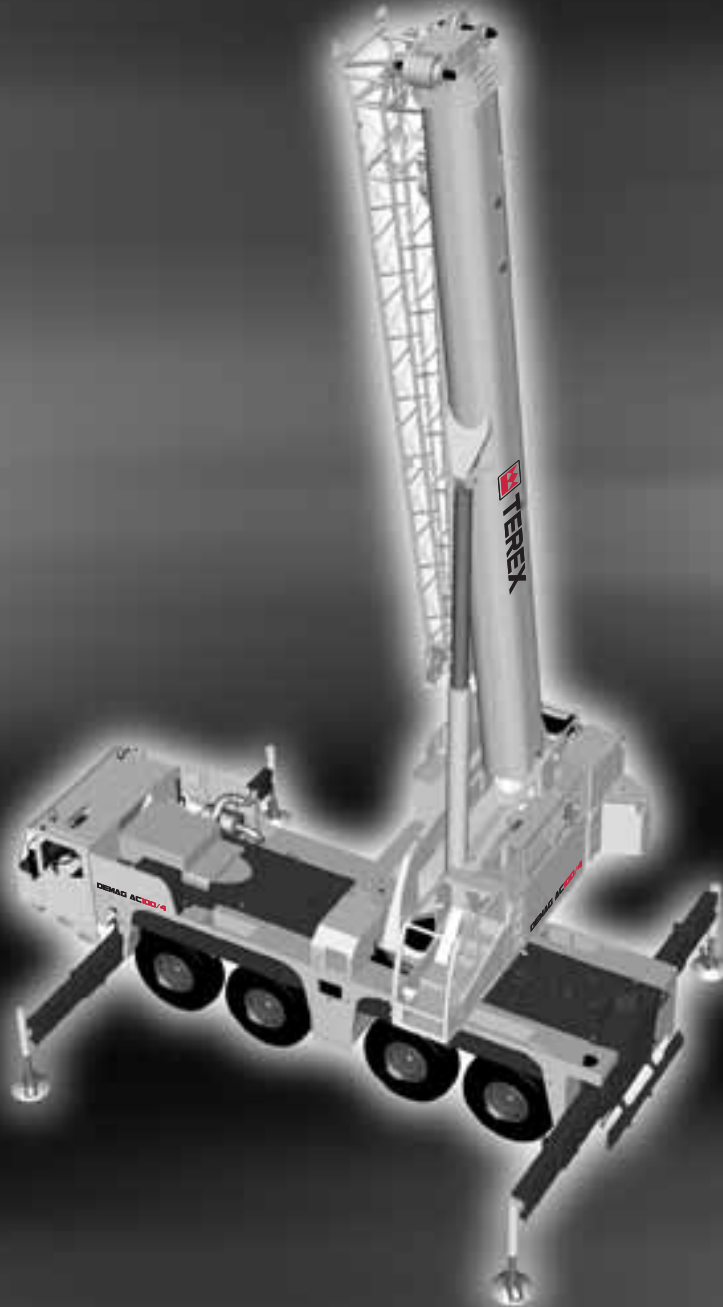

Terex Cranes Wilmington Operations
Mobile hydraulic and lattice-boom cranes
202 Raleigh St. · Wilmington, NC 28412 USA
Phone +1 910 395 8500 · Fax +1 910 395 8538
Email: american@american-crane.com

Order Nr. AC 100/4 usa A1 – 201 381 12