



Grove Maniwoc National Crane Potain



Manitowoc 999

Product Guide



Features

- 250 t (275 USt) capacity
- 1115 m-ton (8,268 ft-kips) maximum load moment
- 88,4 m (290 ft) heavy-lift boom
- 100,6 m (330 ft) fixed jib on heavy-lift boom
- 128,0 m (420 ft) luffing jib on heavy-lift boom



Features



EPIC®

Manitowoc's field-proven Electronically Processed Independent Controls (EPIC) system delivers high productivity and precise load control by instantly matching an operator's commands to the crane function. EPIC's microprocessor maximizes a Manitowoc crane's function capability and simplifies servicing by pinpointing any problem in the crane's engine, power transmission and other operating systems. In addition, EPIC increases versatility by easily tailoring a Manitowoc crane's operation for specialized applications, with or without attachments. EPIC is a key reason no other crane can match the performance and reliability of Manitowoc.

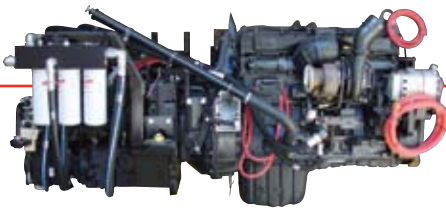

Hydraulics

Our closed-loop system provides a separate hydraulic circuit to power each crane function. The result is truly independent, variable-speed operation of the swing, load hoist, boom hoist and travel functions.



FACT™ Connectors

Manitowoc's patented Fast Aligning Connection Technology (FACT) quickly aligns crane components for fast, safe assembly and disassembly.



Crawler drive shafts

The crawler drive shafts prevent contaminants from entering the system. By eliminating the need to disconnect hydraulic systems, crawler removal and assembly is safer and easier.



Contents

Specifications	5
Outline dimensions	10
Transport data	21
Crane assembly	23
Performance data	24
Boom combinations	36
Heavy-lift boom range / load charts	42
Long-reach boom range / load charts	44
Open throat boom range / load charts	46
Light tapered boom range / load charts	48
Fix jib boom range / load charts	50
Luffing jib boom range / load charts	65
Fixed jib on luffing jib boom range / load charts	74
Manitowoc Crane Care	82



Notes



Specifications

Upperworks



Engine

Cummins Model QSM11 diesel, 6 cylinder, 298 kW (400 BHP) @ 1800 governed RPM.

Includes engine block heater (120 V), ether starting aid, manually operated disconnect clutch for cold weather start, high silencing muffler, hydraulic oil cooler, radiator and fan.

Multiple hydraulic pump drive transmission provides independent power for all machine functions.

Two 12 volt maintenance-free, Group 8D batteries, 1300 CCA at -18°C (0° F), 24 volt starting and 110 amp alternator.

Two diesel fuel tanks for total of 719 L (190 gal) with level indicator in Operator's Cab.



Controls

Modulating electronic-over-hydraulic controls provide infinite speed response directly proportional to control lever movement. Controls include Manitowoc's exclusive EPIC™ *Electronically Processed Independent Control* system providing microprocessor driven control logic, pump control, on-board diagnostics, and service information.

Block-up limit control is standard for hoist and whip lines.

Integrated Rated Capacity Limiter system (RCL) is standard for main boom and upper boom point. "Function cut-out" or "warning only" operation is available via a keyed switch on the RCL console.

➤ Optional travel and swing alarms are available.

➤ Optional foot controls for travel.



Hydraulic system

Six high-pressure piston pumps are driven through a multi-hydraulic pump transmission. These six pumps provide independent "closed loop" hydraulic power for front drum, rear drum, boom hoist system, swing system, and both left and right crawler operation.

<u>System</u>	<u>kg/cm² (psi)</u>	<u>lpm (gpm)</u>
Front Drum	422 (6,000)	379 (100)
Rear Drum	422 (6,000)	379 (100)
Boom Hoist	422 (6,000)	227 (60)
Swing System	386 (5,500)	227 (60)
Left Crawler	422 (6,000)	227 (60)
Right Crawler	422 (6,000)	227 (60)
Auxiliary Pump*	422 (6,000)	379 (100)

➤ *Optional pump powers auxiliary drum on liftcrane.

Hydraulic reservoir capacity is 454 L (120 gal) and is equipped with breather, clean out access, and internal diffuser.

Each function is equipped with relief valves to protect the hydraulic circuit from overload or shock.

Replaceable, spin on ten full flow line filter is furnished in the hydraulic circuit. All oil is filtered prior to suction on closed loop hydraulic pumps.

Hydraulic system also includes pump transmission disconnect clutch and hydraulic oil cooler.



Drums

Two equal width winches 940 mm (37") wide and 540 mm (21-1/4") diameter are driven by independent variable displacement axial piston hydraulic motors through planetary reduction mounted on separate front and rear shafts with anti-friction bearings. Drums are grooved for 26 mm rope.

Powered hoisting/lowering operation is standard with automatic (spring applied, hydraulically released) multi-disc brakes, and drum rotation indicators.

➤ Optional free-fall operation for front and/or rear drum(s). Wet disk brake manually applied by foot pedal with locking latch in operator's cab. Operator may select free-fall or powered lowering mode using a selector switch.

➤ Optional auxiliary (third) hydraulic powered drum rated at 89,0 kN (20,000 lb) line pull mounted in boom butt. Includes third drum control system.

➤ Optional auxiliary drum preparation includes electric wiring, controls, hydraulic pump and plumbing.



Specifications



Boom hoist

Independent boom hoist consists of a 343 mm (13-1/2") wide and 483 mm (19") diameter drum grooved for 22,23 mm (7/8") diameter wire rope. Includes 323,1 m (1,060') of 22,23 mm (7/8") diameter wire rope for 20 part line reeving.

Drum is powered by a fixed displacement hydraulic motor coupled to an internal brake and planetary gearbox equipped with ratcheting pawl.

Boom hoist speed: raise 88,4 m (290') full main boom from 0° - 82° in 2 minutes, 50 seconds.



Mast and gantry

Moving mast is 9,1 m (30') long and connects the boom hoist reeving to the steel boom suspension strap rigging. When used with optional self-erect package, the mast is utilized for crane assembly and disassembly. It is capable of lifting and positioning the crawler assemblies, stacking the counterweights, and assembling the boom and jib.

Gantry includes gantry raising cylinders capable of lifting the entire upperworks counterweight for removal and installation. Counterweight attaches to rotating bed with power actuated pins.

Air cushioned boom stop and automatic boom stop standard.



Counterweight

Qty.	Item	Unit Weight		Total Weight	
		kg	lb	kg	lb
1	Upperworks				
	Tray	9572	21,100	9572	21,100
	Center Box	10 660	23,500	10 660	23,500
6	Upper Side Box	7938	17,500	47 628	105,000
Series 1 total				67 860	149,600
2	Upperworks				
	Upper Side Box	7938	17,500	15 876	35,000
2	Carbody				
	Lower Box	9978	22,000	19 956	44,000
Optional: Add to Series 1 for Series 2 total				103 690	228,600
2	Upperworks				
	Upper Side Box	7938	17,500	15 876	35,000
2	Carbody				
	Lower Box	8165	18,000	16 330	36,000
Optional: Add to Series 1 for Series 2 total				135 896	229,600

Includes connecting pins, brackets, and stops.

➤ Optional low-profile counterweight boxes for Series 3 only. Consists of twelve 6 622 kg (14,600 lb) upper side counterweight boxes in lieu of the standard ten 7 938 kg (17,500 lb) counterweight boxes. Low profile boxes allow greater versatility for transport

of boom and counterweight sections where specific markets have transport restrictions.



Swing system

High strength fabricated steel alloy rotating bed is mounted on 2,76 m (108-9/16") diameter turntable triple-row ball bearing.

Independent swing powered by a fixed displacement hydraulic motor coupled to a planetary gearbox with internal brake. 360° positive swing lock.

Swing system maximum speed: 1.8 rpm.



Operator's cab

Fully enclosed and insulated steel module located on a pivoting mount at the left front corner of rotating bed, allowing module repositioning for transportation. Module is equipped with sliding door, large safety glass windows on all sides and roof. Signal horn, cab space heater, front and roof windshield wipers, dome light, sun visor and shade, fire extinguisher and air circulating fan are standard.

- Optional air conditioner.
- Optional nylon protective window covers.

Lowerworks



Carbody

Connects rotating bed to crawler assemblies. High strength fabricated steel assembly with FACT™ connection system for fast installation and removal of crawler assemblies.



Crawlers

Crawler assemblies are 8,59 m (28' 3") long with 1,22 m (48") wide cast steel crawler pads and sealed "low maintenance" intermediate rollers. Each crawler is identical and can be mounted on either side of the carbody. Each crawler is powered independently by a variable displacement hydraulic motor and includes two hydraulically powered pin actuators for fast installation and removal from carbody. Carbody mounted drive motors are connected to crawler final reduction via telescoping shafts. This permits crawlers to be removed without opening their hydraulic circuits. Crawlers provide ample tractive effort that allows counter



Specifications

rotation with full rated load. Maximum ground speed of 1,61 kph (1.0 mph).

Optional self-erect system includes: carbody jacking cylinders with pads, controls, 41 mton (45 ton) assembly block, boom-butt installation support, and crawler handling chains.

Attachments



No. 82 Heavy-lift main boom

The liftcrane is equipped with a 21,3 m (70') No. 82 basic heavy-lift angle chord boom consisting of a 9,1 m (30') butt and 12,2 m (40') top with eight 76,2 cm (30") diameter roller bearing sheaves on one shaft. Includes rope guides, boom hoist wire rope, and boom angle indicator. The No. 82 boom utilizes steel suspension straps and Manitowoc's patented, exclusive FACT™ connection system. The FACT connection system consists of two vertical pins, two horizontal connection pins and alignment pads for each boom connection location.

Powered boom hinge system including cylinder, piping, operating controls and locking device standard.

Luffing jib preparation included as standard.

Optional 3,0 m (10'), 6,1 m (20'), and 12,2 m (40') No. 82 boom inserts with steel boom suspension straps, and FACT™ connection system.

Optional No. 82 or No. 22EL detachable upper boom point with one 76,2 cm (30") diameter tapered roller bearing steel sheave grooved for 26 mm or (1") rope with rope guard for liftcrane.

Optional No. 22EL basic heavy-lift boom similar to No. 82 described above, but with pinned boom connections and boom suspension pendants in lieu of FACT™ boom connection system and steel boom suspension straps.

Optional 3,0 m (10'), 6,1 m (20'), and 12,2 m (40') No. 22 boom inserts with pinned boom connections and boom suspension pendants.

Optional 12,2 m (40') No. 22C open throat top with six 76,2 cm (30") diameter straight roller bearing sheaves on one shaft and boom suspension pendants. Used with No. 22E boom butt and inserts.

Optional 15,2 m (50') No. 22E light tapered top and 9,1 m (30') tapered insert with pinned boom connections and boom suspension pendants. Used with No. 22E boom butt and inserts.



No. 82 Long reach boom top

Optional 15,2 m (50') No. 82 basic long reach boom top with four 76,2 cm (30") diameter straight roller bearing sheaves. Includes rope guides, steel boom suspension straps, and FACT™ connection system. Utilizes existing 9,1 m (30') butt and No. 82 boom inserts for lengths up to 103,6 m (340'). Requires one 12,2 m (40') light weight boom insert for lengths equal to or greater than 94,4 m (310').



No. 134 Fixed jib

Optional No. 134 basic fixed jib 9,1 m (30') length consisting of 4,6 m (15') jib butt and 4,6 m (15') jib top with 3,7 m (12') jib strut, pendants and backstay. Includes RCL hardware. For use with booms No. 82, No. 82LR, or No. 22EL, or as a fixed jib extension on No. 149 luffing jib.

Optional No. 134 fixed jib inserts 3,0 m (10') and 6,1 m (20') with pendants.

Utilize fixed jib inserts in combination with the No. 134 basic fixed jib for total lengths up to 24,4 m (80').

Note: Jib lengths greater than 18,3 m (60') require the use of at least one 6,1 m (20') No. 134 fixed jib insert.



No. 123 Fixed jib

Optional No. 123 basic fixed jib 9,1 m (30') length consisting of 4,6 m (15') jib butt and 4,6 m (15') jib top with 3,7 m (12') jib strut, pendants and backstay. For use with No. 82LR boom top, No. 22C open throat top or No. 22E light tapered top.

Optional No. 123 fixed jib inserts 3,0 m (10') and 6,1 m (20') with pendants.

Utilize fixed jib inserts in combination with the No. 123 basic fixed jib for total lengths up to 18,3 m (60').



No. 149 Luffing jib

Optional 21,3 m (70') basic No. 149 luffing jib assembly with RCL hardware consisting of 7,6 m (25') butt, 6,1 m (20') insert and 7,6 m (25') top with three 68,6 cm (27") straight roller bearing sheaves and pin connected jib sections, steel jib suspension straps, fixed strut, jib strut, backstay straps, jib point wheel, 26 mm luffing jib hoist line, and FACT™ connection system. Used only with No. 82 heavy-lift boom.



Specifications

➤ Optional 3,0 m (10'), 6,1 m (20'), and 12,2 m (40') No. 149 inserts with steel jib suspension straps. Utilize luffing jib inserts in combination with the No. 149 basic luffing jib for total lengths up to 73,2 m (240').

➤ Optional 6,1 m (20') insert with sheaves and guides for intermediate fall that provides up to two-part load line at intermediate position in luffing jib. Use of insert may require intermediate luffing jib suspension.

➤ Can be assembled in the air.

Note: Only one 3,0 m (10') insert is allowed in the luffing jib.



No. 135 Luffing jib

➤ Optional 21,3 m (70') basic No. 135 luffing jib assembly with RCL hardware consisting of 8,2 m (27') butt, 6,1 m (20') insert, and 7,0 m (23') top with two 68,6 cm (27") straight roller bearing sheaves and pin connected jib sections, pendants, fixed strut, jib strut, backstay pendants, boom point wheel, 26 mm luffing jib hoist line. For use with No. 82 or No. 22EL boom.

➤ Optional 3,0 m (10'), 6,1 m (20'), and 12,2 m (40') No. 135 inserts with pendants. Utilize luffing jib inserts in combination with the No. 135 basic luffing jib for total lengths up to 57,8 m (170').

➤ Optional luffing jib fold-under erection equipment includes wire rope guide and manual pin release parts to allow jib to fold under.

Note: Only one 3,0 m (10') insert is allowed in the luffing jib.

Note: 7 m (23') top, inserts, and pendants for inserts from No. 23 boom can be used as part of No. 135 luffing jib. No. 23 boom top requires modifications.



No. 138 Fixed jib extension

➤ Optional 9,1 m (30') basic fixed jib extension includes jib stop, backstay, wheel, and mounting parts for use on No. 135 luffing jib.

➤ Optional No. 138 3,0 m (10') inserts with pendants. Utilize fixed jib inserts in combination with the No. 138 basic fixed jib extension for total lengths up to 18,3 m (60').

Note: 4,6 m (15') top, 3,0 m (10') inserts, pendants for inserts, and 5,5 m (18') strut from No. 124 fixed jib

can be used as part of No. 138 fixed jib extension. No. 124 jib top requires modifications.

Optional equipment

➤ Optional blocks and hooks –

13,6 mton (15 ton) swivel hook and weight ball.
41 mton (45 ton) hook block with one 76,2 cm (30") sheave for 26 mm or (1") wire rope with swivel hook, hook latch, and swivel lock (assembly block).

54 mton (60 ton) hook block with two 76,2 cm (30") sheaves for 26 mm or (1") wire rope with swivel hook, hook latch, and swivel lock.

91 mton (100 ton) hook block with three 76,2 cm (30") sheaves for 26 mm or (1") wire rope with swivel hook, hook latch, and swivel lock.
181,4 mton (200 ton) hook block with six 76,2 cm (30") sheaves for 26 mm or (1") wire rope with swivel hook, hook latch, and swivel lock

Upper block single sheave to be added to
181,4 mton (200 ton) load block for upgrade to 208,6 mton (230 ton) capacity

200 mton (220 ton) hook block with seven 76,2 cm (30") sheaves for 26 mm or (1") wire rope with swivel hook, hook latch, and swivel lock
227 mton (250 ton) hook block with eight 76,2 cm (30") sheaves for 26 mm or (1") wire rope with swivel hook, hook latch, and swivel lock.

➤ Optional hydraulic test kit: required to properly analyze the performance of the EPIC® control system.

➤ Optional service interval kits: for the regularly scheduled maintenance of general crane operations.

➤ Optional lighting packages: consult factory for available options.

➤ Optional special paint: in color(s) other than Manitowoc standard red and black.

➤ Optional special customer decals: custom vinyl decal(s) of name and/or logo from artwork supplied by customer.

➤ Optional export packaging: basic crane, boom and jib sections.

Optional applications

➤ Options for limited clamshell work: guide bars for lower boom point; Rud-O-Matic® No. 1866 spring-powered three-barrel tagline with 76,2 cm (36") diameter wheel; and pressure rollers for the front and rear hoisting drums. Front drum is closing line. Rear



Specifications

drum is holding line. Manitowoc's EPIC® controls can be changed from liftcrane to clamshell mode with the flip of a switch.

On units equipped with the (pin-connected, pendant-supported) 22EL boom, it is also possible to replace the "L" boom top with the open-throat top for improved performance in clamshell operation. The open throat top may not be mounted to the (FACT™ connected, strap-supported) No. 82 boom.

➤ Options for dedicated clamshell work. Manitowoc recommends: the open throat top, detachable upper boom point with two 91,4 cm (36") diameter roller-bearing-mounted sheaves and cheek plates, pressure rollers on the front and rear drums, and Rud-O-Matic® No. 1866 spring-powered three-barrel tagline with 76,2 cm (30") diameter wheel. Freefall hoisting drums are also recommended. Front drum is closing line. Rear drum is holding line.

➤ Options for limited dragline work. Manitowoc recommends these options: Guide bars for lower boom point; pressure rollers for the front and rear hoisting drums, freefall drums, and fairlead with dirt guard. Front drum is drag line. Rear drum is hoist line. Manitowoc's EPIC® controls can be changed from liftcrane to dragline mode with the flip of a switch.

On units equipped with (pin-connected, pendant-supported) 22EL boom, it is also possible to replace the "L" boom top with the open-throat top for improved performance in dragline operation. The open throat top may not be mounted to the (FACT™-connected, strap-supported) No. 82 boom.



Outline dimensions

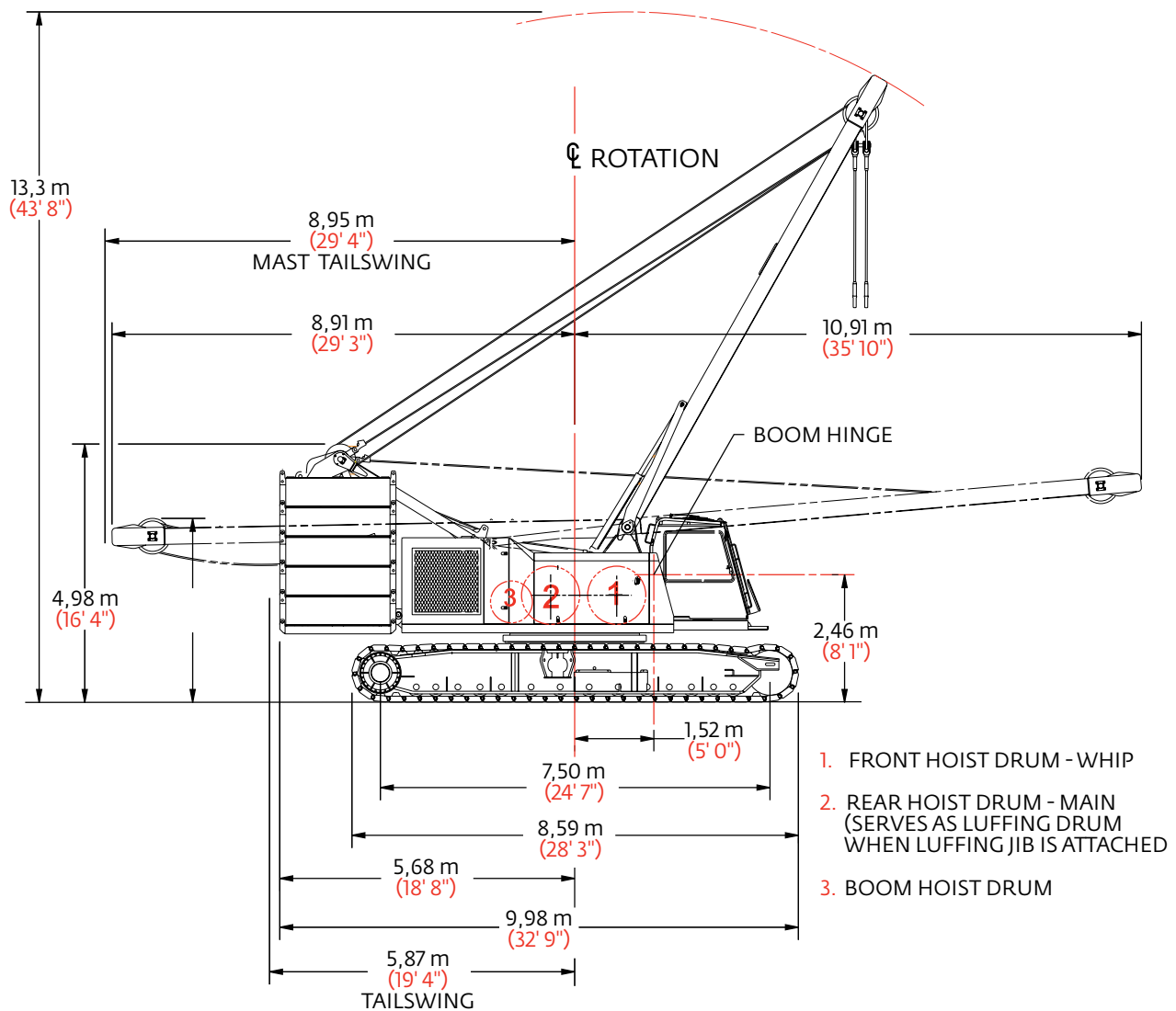



Outline dimensions

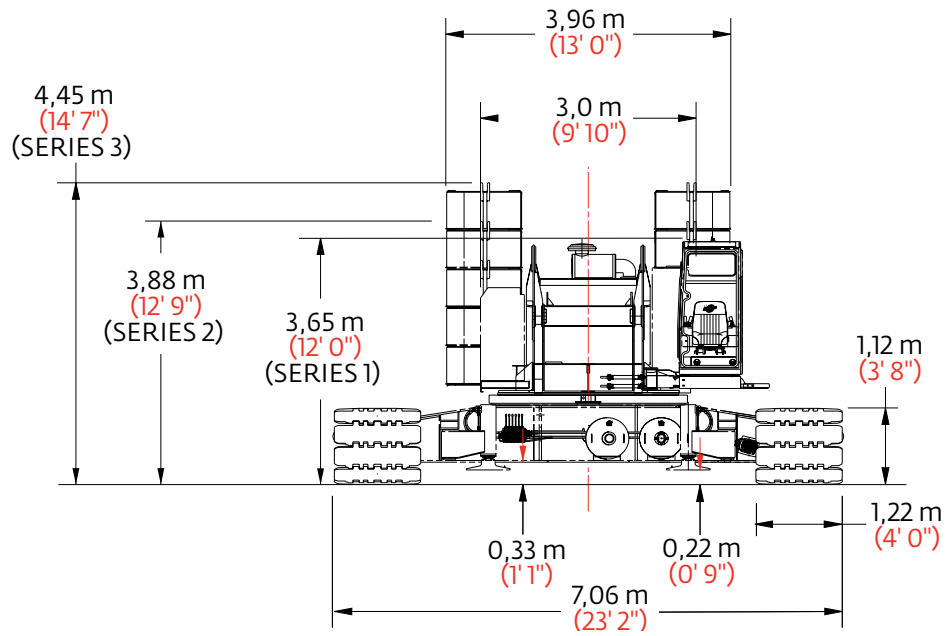



Outline dimensions

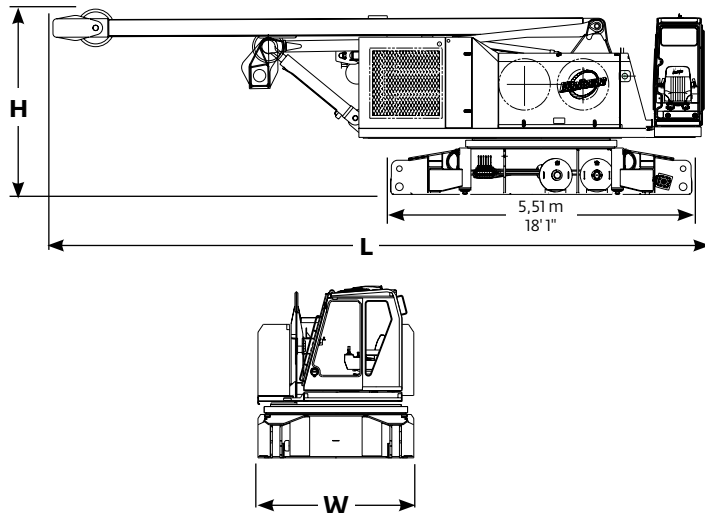

Basic crane x 1

Length	11,87 m	38' 11"
Width	3,00 m	9' 10"
Height	3,38 m	11' 1"
Weight	39 689 kg	87,500 lb

Note: Weight includes carbody, upperworks, operator's cab, gantry, backhitch, mast, boom-hoist wire rope, maximum hoist and whip lines on drums, optional self-assembly jacks, full hydraulic fluid reservoir, and half tank of fuel.

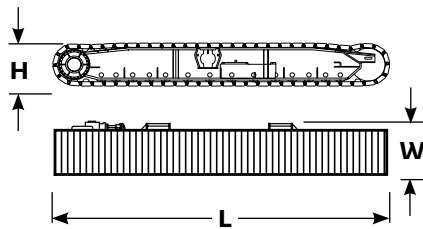

Crawlers with catwalks x 2

Length	8,59 m	28' 3"
Width	1,48 m	4' 10"
Height	1,30 m	4' 3"
Weight	19 622 kg	43,260 lb

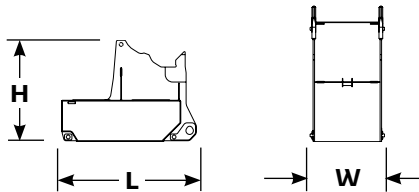

Upper center counterweight x 1

Length	2,31 m	7' 7"
Width	1,27 m	4' 2"
Height	1,71 m	5' 7"
Weight	10 659 kg	23,500 lb

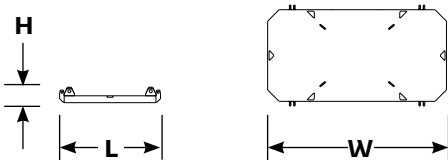

Counterweight tray x 1

Length	2,24 m	7' 4"
Width	3,96 m	13' 0"
Height	0,34 m	1' 2"
Weight	9 548 kg	21,050 lb

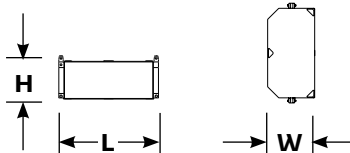

Upper side counterweight standard profile

Series 1		x 6
Series 2		x 8
Series 3		x 10

Length	2,24 m	7' 4"
Width	1,07 m	3' 6"
Height	0,69 m	2' 3"
Weight	7 938 kg	17,500 lb



Outline dimensions

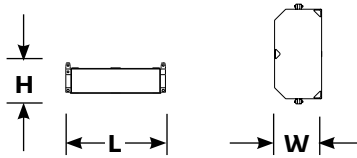

Upper side counterweight optional low profile Series 3 only		
		x 12
Length	2,24 m	7' 4"
Width	1,07 m	3' 6"
Height	0,48 m	1' 7"
Weight	6 611 kg	14,485 lb

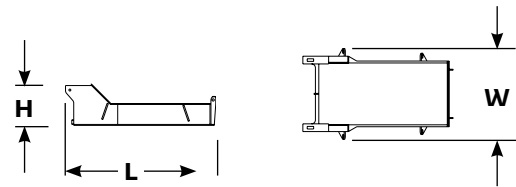

Lower carbody counterweight Series 2, 3		
		x 2
Length	2,97 m	9' 9"
Width	1,80 m	5' 11"
Height	0,82 m	2' 8"
Weight	9 979 kg	22,000 lb

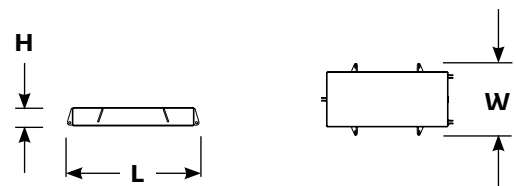

Upper carbody counterweight Series 3		
		x 2
Length	2,74 m	9' 0"
Width	1,50 m	4' 11"
Height	0,39 m	1' 4"
Weight	8 165 kg	18,000 lb

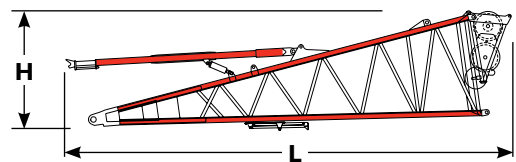

No. 82 Boom butt 9,1 m (30') and wire rope guide, boom stop		
		x 1
Length	10,49 m	34' 5"
Width	2,41 m	7' 11"
Height	2,71 m	8' 11"
Weight	4 910 kg	10,825 lb

Note: Includes boom butt support for self-erect option, boom angle indicator, and cable reel.

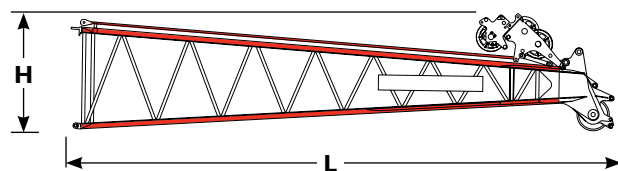

No. 82 Boom top 12,2 m (40') and wire rope guide, straps		
		x 1
Length	12,75 m	41' 10"
Width	2,41 m	7' 11"
Height	2,82 m	9' 3"
Weight	5 609 kg	12,365 lb

Option



Outline dimensions

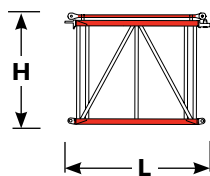

	No. 82 Main boom 3,0 m (10')		
	insert and straps		x 1, 2
	Length	3,20 m	10' 6"
	Width	2,41 m	7' 11"
	Height	2,59 m	8' 6"
	Weight	971 kg	2,140 lb

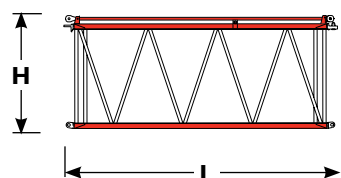

	No. 82 Main boom 6,1 m (20')		
	insert and straps		x 1, 2
	Length	6,25 m	20' 6"
	Width	2,41 m	7' 11"
	Height	2,54 m	8' 4"
	Weight	1 397 kg	3,080 lb

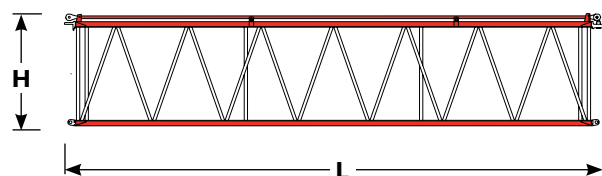

	No. 82 Main boom 12,2 m (40')		
	insert and straps		x 1, 2, 3, 4, 5
	Length	12,34 m	40' 6"
	Width	2,41 m	7' 11"
	Height	2,54 m	8' 4"
	Weight	2 431 kg	5,360 lb

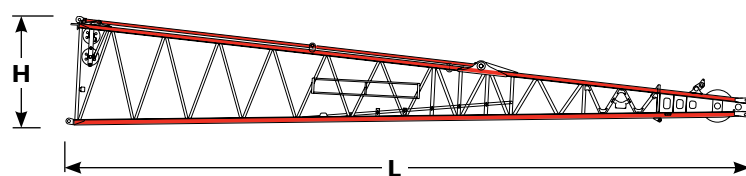

	No. 82 Long reach boom top		
	15,2 m (50') and wire rope guide,		
	straps		x 1
	Length	16,02 m	52' 7"
	Width	2,41 m	7' 11"
	Height	2,54 m	8' 4"
	Weight	3 216 kg	7,090 lb

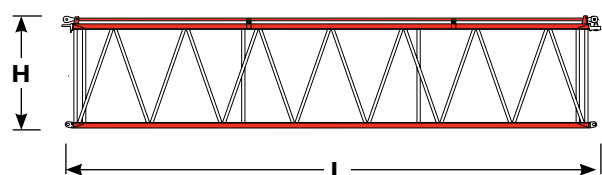

	No. 82 Long reach boom,		
	light weight 12,2 m (40') insert		
	and straps		x 1
	Length	12,34 m	40' 6"
	Width	2,41 m	7' 11"
	Height	2,54 m	8' 4"
	Weight	2 137 kg	4,715 lb

Option



Outline dimensions

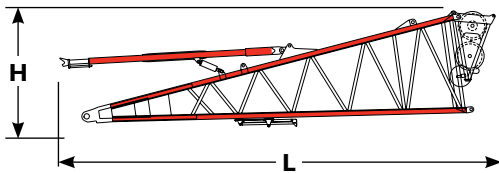

No. 22E Boom butt 9,1 m (30') and wire rope guide, boom stop x 1		
Length	10,49 m	34' 5"
Width	2,41 m	7' 11"
Height	2,71 m	8' 11"
Weight	4 791 kg	10,570 lb

Note: Includes boom butt support for self-erect option, boom angle indicator, and cable reel.

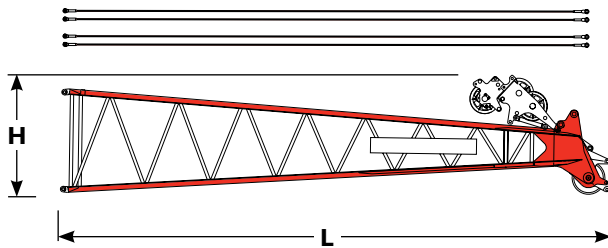

No. 22L Boom top 12,2 m (40') and wire rope guide, pendants x 1		
Length	12,75 m	41' 10"
Width	2,41 m	7' 11"
Height	2,82 m	9' 3"
Weight	5 255 kg	11,585 lb

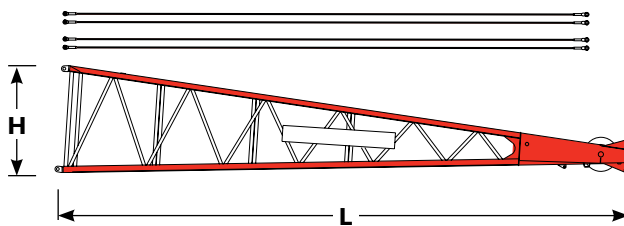

No. 22C Boom top 12,2 m (40') and wire rope guide, pendants x 1		
Length	12,89 m	42' 4"
Width	2,41 m	7' 11"
Height	2,41 m	7' 11"
Weight	4 437 kg	9,780 lb

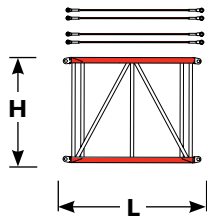

No. 22E Main boom 3,0 m (10') insert and pendants x 1, 2		
Length	3,18 m	10' 5"
Width	2,41 m	7' 11"
Height	2,57 m	8' 5"
Weight	874 kg	1,935 lb

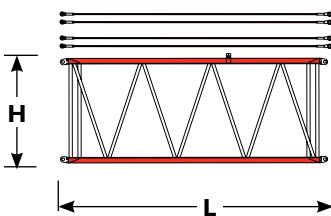

No. 22E Main boom 6,1 m (20') insert and pendants x 1, 2		
Length	6,22 m	20' 5"
Width	2,41 m	7' 11"
Height	2,57 m	8' 5"
Weight	1 416 kg	3,130 lb

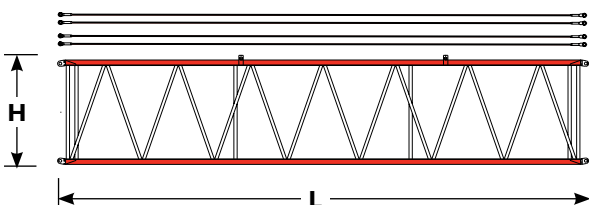

No. 22E Main boom 12,2 m (40') insert and pendants x 1, 2, 3, 4, 5		
Length	12,32 m	40' 5"
Width	2,41 m	7' 11"
Height	2,57 m	8' 5"
Weight	2 404 kg	5,300 lb

Option



Outline dimensions

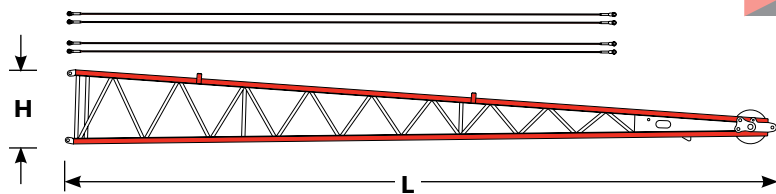

**No. 22E Light tapered top
15,2 m (50') and pendants** x 1

Length	15,90 m	52' 2"
Width	1,91 m	6' 3"
Height	1,67 m	5' 6"
Weight	2 967 kg	6,540 lb

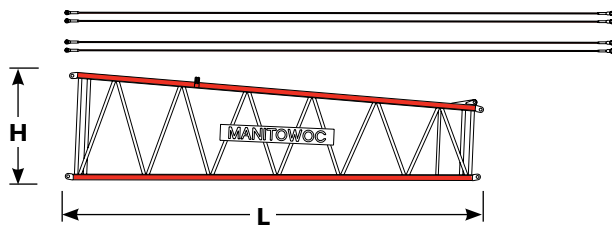

**No. 22E Light tapered top
9,1 m (30') tapered insert
and pendants** x 1

Length	9,27 m	30' 5"
Width	2,41 m	7' 11"
Height	2,41 m	7' 11"
Weight	1 855 kg	4,090 lb

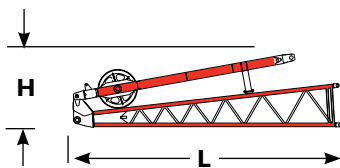

**No. 134 Jib butt 4,6 m (15')
and strut, stop** x 1

Length	4,67 m	15' 4"
Width	0,86 m	2' 10"
Height	1,29 m	4' 3"
Weight	635 kg	1,400 lb

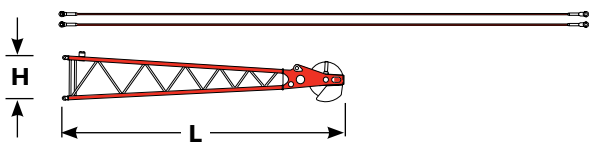

**No. 134 Jib top 4,6 m (15')
and pendants** x 1

Length	4,93 m	16' 2"
Width	0,79 m	2' 7"
Height	0,79 m	2' 7"
Weight	553 kg	1,220 lb

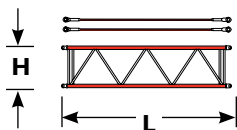

**No. 134 Jib insert 3,0 m (10')
and pendants** x 1

Length	3,12 m	10' 3"
Width	0,79 m	2' 7"
Height	0,79 m	2' 7"
Weight	218 kg	480 lb

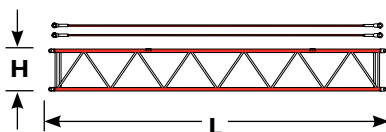

**No. 134 Jib insert 6,1 m (20')
and pendants** x 1, 2

Length	6,17 m	20' 3"
Width	0,79 m	2' 7"
Height	0,79 m	2' 7"
Weight	340 kg	750 lb

Option



Outline dimensions

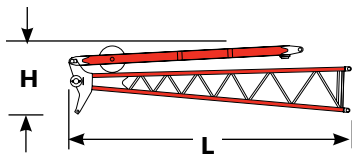

No. 123 Jib butt 4,6 m (15') and strut		
		x 1
Length	4,75 m	15' 7"
Width	0,86 m	2' 10"
Height	1,16 m	3' 10"
Weight	460 kg	1,015 lb

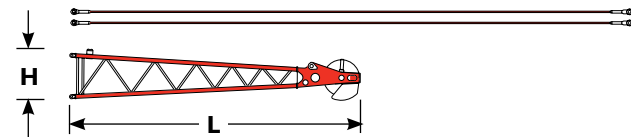

No. 123 Jib top 4,6 m (15') and pendants		
		x 1
Length	4,93 m	16' 2"
Width	0,79 m	2' 7"
Height	0,79 m	2' 7"
Weight	422 kg	930 lb

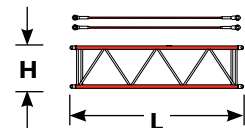

No. 123 Jib insert 3,0 m (10') and pendants		
		x 1, 2, 3
Length	3,12 m	10' 3"
Width	0,79 m	2' 7"
Height	0,79 m	2' 7"
Weight	217 kg	480 lb

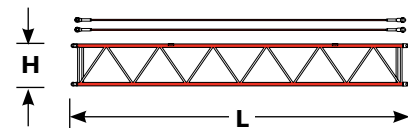

No. 123 Jib insert 6,1 m (20') and pendants		
		x 1
Length	6,17 m	20' 3"
Width	0,79 m	2' 7"
Height	0,79 m	2' 7"
Weight	341 kg	750 lb

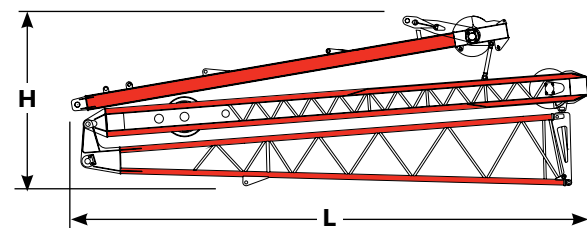

No. 135 Luffing jib 8,2 m (27') butt and truts		
		x 1
Length	8,81 m	28' 11"
Width	1,57 m	5' 2"
Height	2,92 m	9' 7"
Weight	4 477 kg	9,870 lb

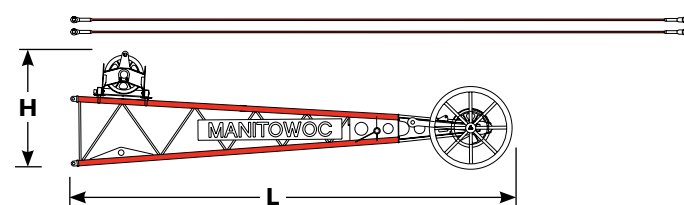

No. 135 Luffing jib top 7,0 m (23') and roller, pendants		
		x 1
Length	7,80 m	25' 7"
Width	1,52 m	5' 0"
Height	2,02 m	6' 8"
Weight	1 984 kg	4,375 lb

Note: Includes wire rope guide.

Option



Outline dimensions

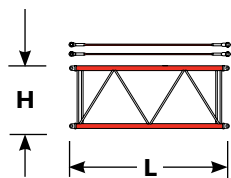

No. 135 Luffing jib insert 3,0 m (10') and pendants			x 1
Length	3,15 m	10' 4"	
Width	1,52 m	5' 0"	
Height	1,30 m	4' 3"	
Weight	381 kg	840 lb	

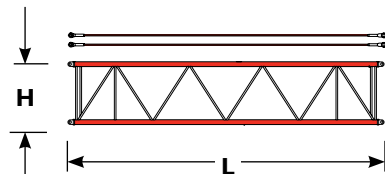

No. 135 Luffing jib insert 6,1 m (20') and pendants			x 1, 2
Length	6,20 m	20' 4"	
Width	1,52 m	5' 0"	
Height	1,30 m	4' 3"	
Weight	612 kg	1,350 lb	

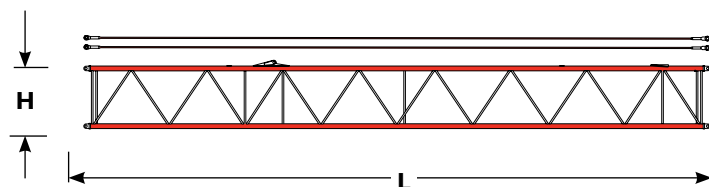

No. 135 Luffing jib insert 12,2 m (40') and pendants			x 1, 2, 3
Length	12,29 m	40' 4"	
Width	1,52 m	5' 0"	
Height	1,30 m	4' 3"	
Weight	1 050 kg	2,315 lb	

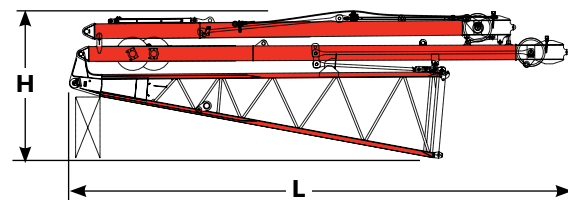

No. 149 Luffing jib 7,6 m (25') butt and struts			x 1
Length	10,41 m	34' 2"	
Width	2,08 m	6' 10"	
Height	3,10 m	10' 2"	
Weight	5 718 kg	12,620 lb	

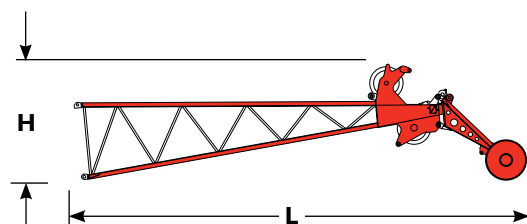

No. 149 Luffing jib top 7,6 m (25') and roller, straps			x 1
Length	10,24 m	33' 7"	
Width	2,08 m	6' 10"	
Height	2,49 m	8' 2"	
Weight	2 664 kg	5,875 lb	

Note: Includes wire rope guide, roller and sheave for upper boom point.

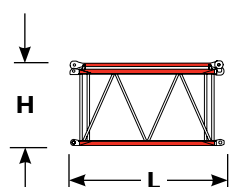

No. 149 Luffing jib insert 3,0 m (10') and straps			x 1
Length	3,23 m	10' 7"	
Width	2,08 m	6' 10"	
Height	1,91 m	6' 3"	
Weight	578 kg	1,280 lb	

Option



Outline dimensions

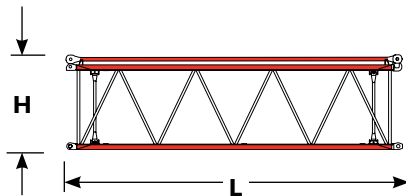

No. 149 Luffing jib insert 6,1 m (20') and straps			x 1, 2
Length	6,27 m	20' 7"	
Width	2,08 m	6' 10"	
Height	1,91 m	6' 3"	
Weight	941 kg	2,080 lb	

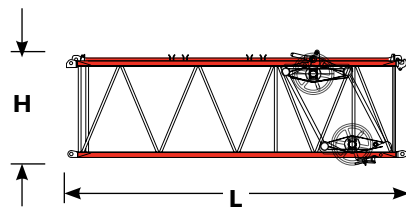

No. 149 Luffing jib insert INTERMEDIATE FALL 6,1 m (20') and straps			x 1
Length	6,27 m	20' 7"	
Width	2,08 m	6' 10"	
Height	2,49 m	8' 2"	
Weight	374 kg	3,035 lb	

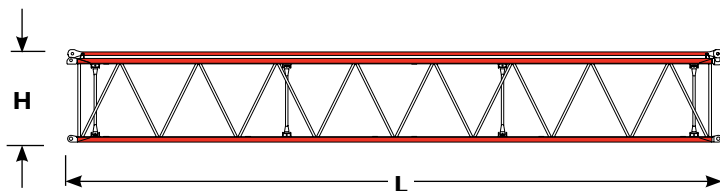

No. 149 Luffing jib insert 12,2 m (40') and straps			x 1, 2, 3, 4
Length	12,37 m	40' 7"	
Width	2,08 m	6' 10"	
Height	1,91 m	6' 3"	
Weight	1 660 kg	3,665 lb	

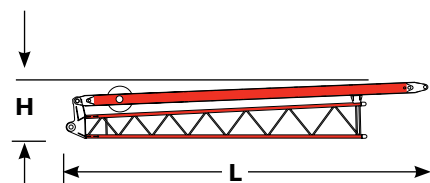

No. 138 Fixed jib 4,6 m (15') butt and strut			x 1
Length	5,64 m	18' 6"	
Width	2,08 m	6' 10"	
Height	1,91 m	6' 3"	
Weight	350 kg	775 lb	

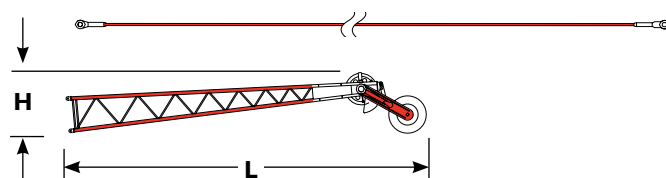

No. 138 Fixed jib 4,6 m (15') top and roller, pendant			x 1
Length	5,51 m	18' 1"	
Width	0,76 m	2' 6"	
Height	1,05 m	3' 5"	
Weight	370 kg	817 lb	

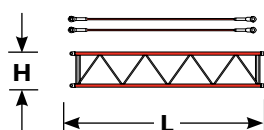

No. 138 Jib insert 3,0 m (10') and pendants			x 1, 2, 3
Length	3,12 m	10' 3"	
Width	0,76 m	2' 6"	
Height	0,58 m	1' 11"	
Weight	98 kg	215 lb	

Option



Outline dimensions

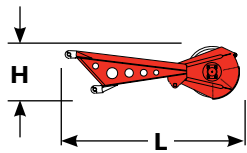

No. 82 or No. 22EL Upper boom point			x 1	
Length	2,64 m		8' 8"	
Width	0,41 m		1' 4"	
Height	0,81 m		2' 8"	
Weight	420 kg		925 lb	

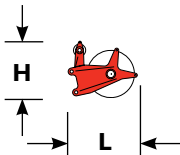

No. 82 Long reach boom top upper boom point			x 1	
Length	1,09 m		3' 7"	
Width	0,37 m		1' 3"	
Height	1,01 m		3' 4"	
Weight	157 kg		345 lb	

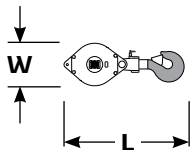

Hook block for 26 mm or (1") wire rope				
Capacity	227 mt	250 t	Length	2,39 m 7' 10"
Weight	2 744 kg	6,050 lb	Width	0,94 m 3' 1"
Capacity*	200 mt	220 t	Length	2,28 m 7' 5"
Weight	3 026 kg	6,670 lb	Width	0,89 m 2' 11"
Capacity	182 mt	200 t	Length	2,28 m 7' 5"
Weight	2 540 kg	5,600 lb	Width	0,89 m 2' 11"
Capacity	91 mt	100 t	Length	1,98 m 6' 6"
Weight	1 769 kg	3,900 lb	Width	0,89 m 2' 11"
Capacity	55 mt	60 t	Length	1,80 m 5' 11"
Weight	1 202 kg	2,650 lb	Width	0,89 m 2' 11"

*Single sheave upper block can be added for 208,6 mton (230 ton) capacity.

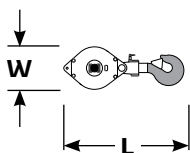

Self assembly hook block for 26 mm or (1") wire rope				
Capacity	41 mt	45 t	Length	1,83 m 6' 0"
Weight	1 179 kg	2,600 lb	Width	0,91 m 3' 0"

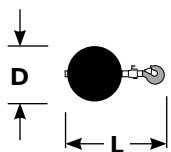

Weight ball				
Capacity/Swivel	13,6 mt	15 t	Diameter	0,56 m 1' 10"
Weight	594 kg	1 310 lb	Length	1,07 m 3' 6"



Transport data

Trailer load out summary													
Item	Model 999 Series 3 No. 134 Fixed Jib 24,4 m (80') and No. 82 Boom 91,4 m (300')												
	Weight each item	Quantity on Trailer Load #											
	Kg (lb)	1	2	3	4*	5	6	7	8	9	10	11	12
No. 999 Basic crane	39 689 (87,500)	1											
Crawler assembly	19 622 (43,260)		1	1									
Counterweight tray	9 548 (21,050)						1						
Upper center counterweight	10 659 (23,500)						1						
Upper side counterweight	7 938 (17,500)				2	2		2	2	2			
Lower carbody counterweight	9 979 (22,000)										1	1	
Upper carbody counterweight	8 165 (18,000)												2
9,1 m (30') No. 82 Boom butt**	4 910 (10,825)				1								
12,2 m (40') No. 82 Boom top	5 609 (12,365)					1							
3,0 m (10') No. 82 Boom insert	971 (2,140)												1
6,1 m (20') No. 82 Boom insert	1 397 (3,080)												1
12,2 m (40') No. 82 Boom Insert***	2 431 (5,360)							1	1	1	1	1***	
10,0 m (30') No. 134 Jib & strut	1 188 (2,620)	1											
3,0 m (10') No. 134 Jib insert	218 (480)	1											
6,1 m (20') No. 134 Jib Insert	340 (750)		2										
227 mton (250 ton) Hook block	2 744 (6,050)										1		
41 mton (45 ton) Self-assembly block	1 179 (2,600)		1										
13,6 mton (15 ton) Weight ball	594 (1,310)											1	
No. 82 Upper boom point	420 (925)											1	
Miscellaneous	1 814 (4,000)										1	1	
Approximate total shipping weight kg (lb)		39 689 (87,500)	21 028 (46,360)	21 481 (47,360)	20 786 (45,825)	21 485 (47,365)	20 207 (44,550)	18 307 (40,360)	18 307 (40,360)	18 307 (40,360)	16 968 (37,410)	15 238 (33,595)	18 698 (41,220)

* Step deck trailer recommended.

** Does not include auxiliary drum.

*** One insert includes jib backstay lugs.



Transport data

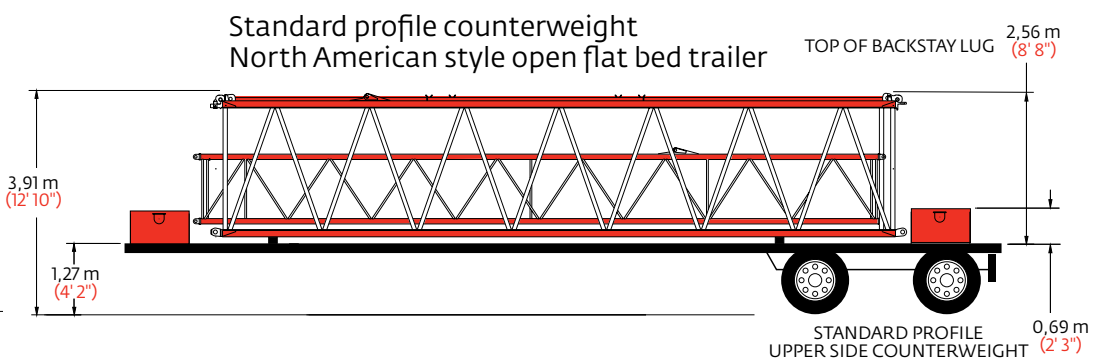
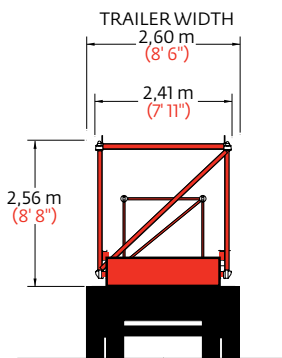
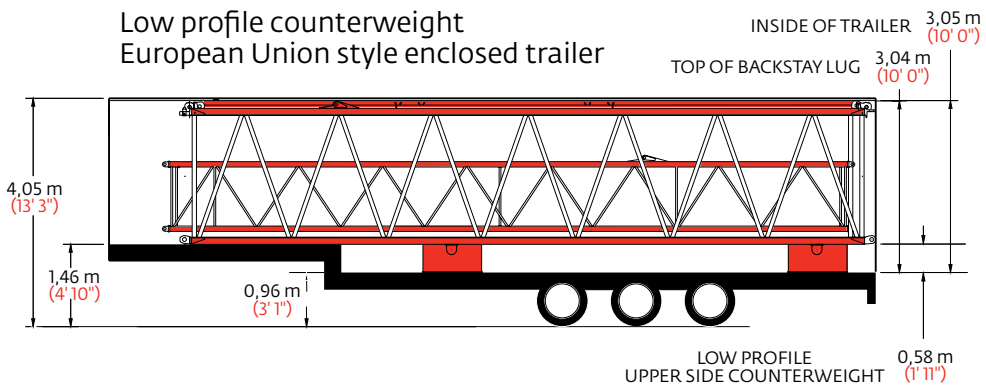
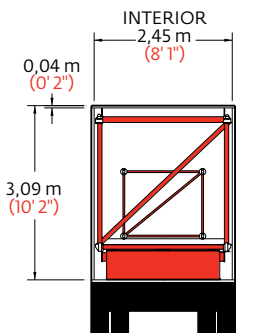
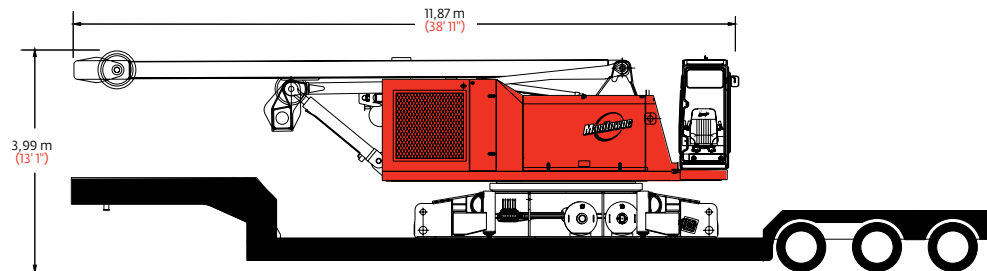
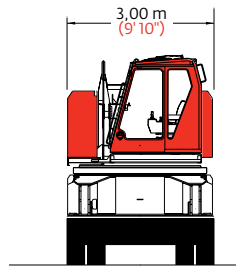



Crane assembly

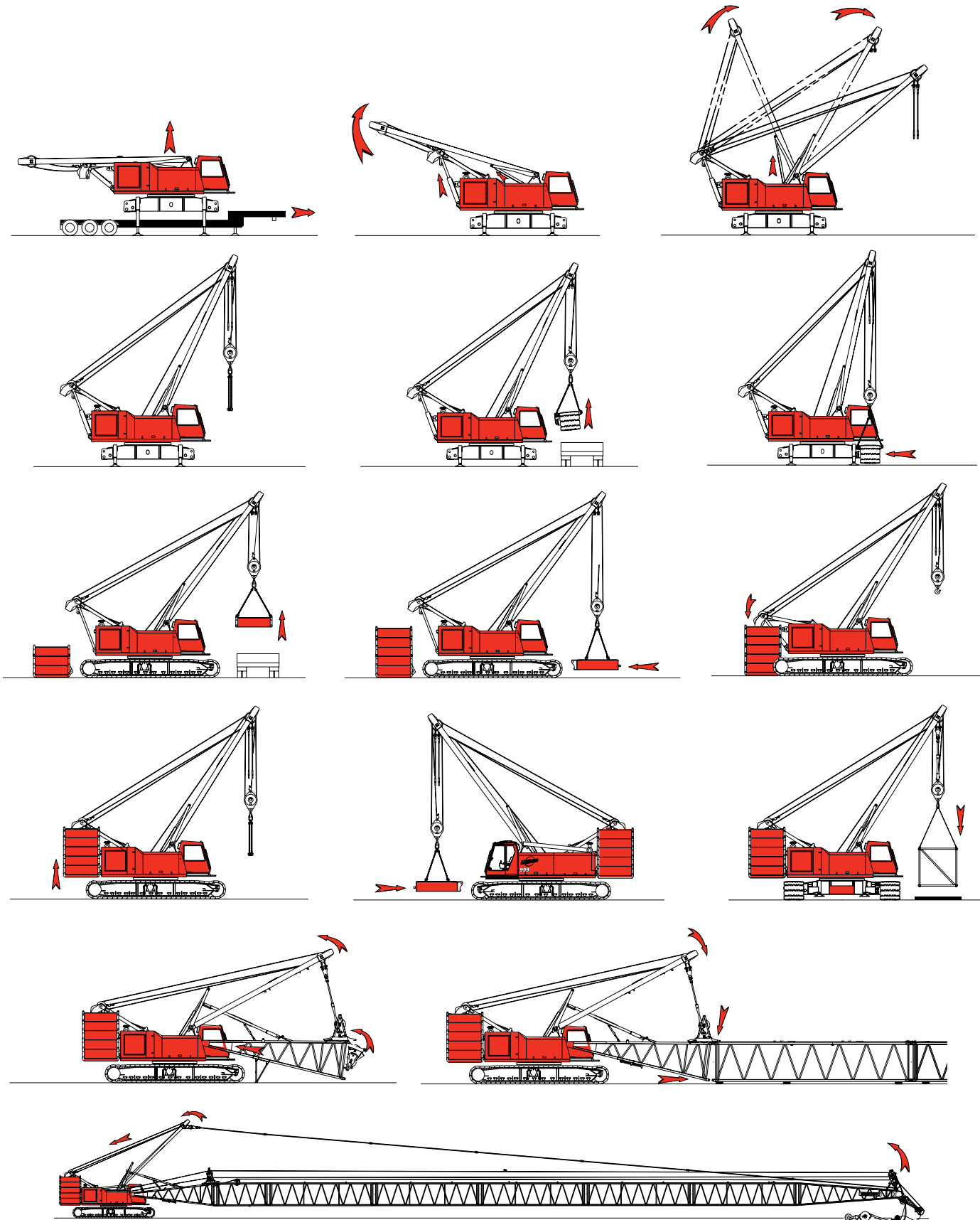

Note: Read the assembly folio in the operator's manual for a complete description of approved crane assembly procedures.



Performance data

Wire rope lengths Boom No. 82 or No. 22EL - or - Fixed jib No. 134 on boom No. 82 or No. 22EL							
Boom or boom and fixed jib length	Whip line				Hoist line		Maximum required parts of line
	Front or aux drum (1 part of line)		Front or aux drum (2 parts of line)		Rear drum		
	m	(ft)	m	(ft)	m	(ft)	
21,3 (70)	55	(180)	82	(270)	404	(1,325)	16
24,4 (80)	61	(200)	91	(300)	457	(1,500)	16
27,4 (90)	67	(220)	101	(330)	457	(1,500)	14
30,5 (100)	73	(240)	110	(360)	495	(1,625)	14
33,5 (110)	79	(260)	119	(390)	495	(1,625)	12
36,6 (120)	85	(280)	128	(420)	495	(1,625)	11
39,6 (130)	91	(300)	137	(450)	495	(1,625)	10
42,7 (140)	98	(320)	146	(480)	495	(1,625)	10
45,7 (150)	104	(340)	152	(500)	495	(1,625)	9
48,8 (160)	110	(360)	162	(530)	495	(1,625)	8
51,8 (170)	116	(380)	171	(560)	495	(1,625)	8
54,9 (180)	122	(400)	180	(590)	495	(1,625)	7
57,9 (190)	128	(420)	189	(620)	495	(1,625)	7
61,0 (200)	134	(440)	198	(650)	495	(1,625)	6
64,0 (210)	140	(460)	207	(680)	495	(1,625)	6
67,1 (220)	146	(480)	216	(710)	495	(1,625)	6
70,1 (230)	152	(500)	226	(740)	495	(1,625)	5
73,2 (240)	158	(520)	235	(770)	495	(1,625)	5
76,2 (250)	165	(540)	244	(800)	495	(1,625)	4
79,2 (260)	171	(560)	253	(830)	495	(1,625)	4
82,3 (270)	177	(580)	262	(860)	495	(1,625)	4
85,3 (280)	183	(600)	271	(890)	495	(1,625)	3
88,4 (290)	189	(620)	280	(920)	495	(1,625)	3
91,4 (300)	195	(640)	290	(950)	—	—	—
94,5 (310)	201	(660)	299	(980)	—	—	—
97,5 (320)	207	(680)	308	(1,010)	—	—	—
100,6 (330)	213	(700)	—	—	—	—	—

NOTE: Line lengths given in table will allow hook to touch ground. When block travel below ground is required, add additional rope equal to parts of line times added travel distance. Hoisting distance or line pull may be limited when block travel below ground is required.

Front and rear drums each provide 131 kN (29,500 lb) maximum single line pull.
Auxiliary drum provides 89 kN (20,000 lb) maximum single line pull.



Performance data

Wire rope lengths Luffing jib No. 149 on boom No. 82

Boom length m (ft)	Hoist line Front drum		Whip line Front drum or auxiliary drum				Intermediate fall line Auxiliary drum			
			1 Part		2 Part		1 Part		2 Part	
	m	(ft)	m	(ft)	m	(ft)	m	(ft)	m	(ft)
24,4 (80)	381	(1250)	210	(690)	312	(1025)	140	(460)	210	(690)
27,4 (90)	396	(1300)	216	(710)	328	(1075)	146	(480)	219	(720)
30,5 (100)	396	(1300)	223	(730)	335	(1100)	152	(500)	229	(750)
33,5 (110)	411	(1350)	229	(750)	343	(1125)	158	(520)	238	(780)
36,6 (120)	411	(1350)	235	(770)	351	(1150)	165	(540)	247	(810)
39,6 (130)	427	(1400)	241	(790)	358	(1175)	171	(560)	256	(840)
42,7 (140)	442	(1450)	247	(810)	373	(1225)	177	(580)	265	(870)
45,7 (150)	442	(1450)	253	(830)	381	(1250)	183	(600)	274	(900)
48,8 (160)	442	(1450)	259	(850)	389	(1275)	189	(620)	283	(930)
51,8 (170)	442	(1450)	265	(870)	396	(1300)	195	(640)	293	(960)
54,9 (180)	442	(1450)	271	(890)	404	(1325)	201	(660)	302	(990)
57,9 (190)	442	(1450)	277	(910)	419	(1375)	207	(680)	311	(1020)
61,0 (200)	442	(1450)	283	(930)	427	(1400)	213	(700)	320	(1050)

NOTE: Line lengths given in table will allow hook to touch ground. When block travel below ground is required, add additional rope equal to parts of line times added travel distance. Hoisting distance or line pull may be limited when block travel below ground is required.

Front and rear drums each provide 131 kN (29,500 lb) maximum single line pull.

Auxiliary drum provides 89 kN (20,000 lb) maximum single line pull.



Performance data

Wire rope lengths Luffing jib No. 135 on boom No. 82 or No. 22EL						
Boom and luffing jib length	Luffing jib hoist line					
	Front drum		Maximum required parts of line	Auxiliary drum		Maximum required parts of line
m (ft)	m	(ft)		m	(ft)	
42,7 (140)	229	(750)	4	229	(750)	4
45,7 (150)	244	(800)	4	244	(800)	4
48,8 (160)	259	(850)	4	259	(850)	4
51,8 (170)	274	(900)	4	274	(900)	4
54,9 (180)	290	(950)	4	290	(950)	4
57,9 (190)	305	(1,000)	4	305	(1,000)	4
61,0 (200)	320	(1,050)	4	320	(1,050)	4
64,0 (210)	335	(1,100)	4	335	(1,100)	4
67,1 (220)	351	(1,150)	4	351	(1,150)	4
70,1 (230)	336	(1,200)	4	336	(1,200)	4
73,2 (240)	381	(1,250)	4	381	(1,250)	4
76,2 (250)	381	(1,250)	3	396	(1,300)	4
79,2 (260)	381	(1,250)	3	411	(1,350)	4
82,3 (270)	381	(1,250)	3	427	(1,400)	4
85,3 (280)	381	(1,250)	3	442	(1,450)	4
88,4 (290)	381	(1,250)	3	457	(1,500)	4
91,4 (300)	381	(1,250)	2	457	(1,500)	3
94,5 (310)	381	(1,250)	2	457	(1,500)	3
97,5 (320)	381	(1,250)	2	457	(1,500)	3
100,6 (330)	381	(1,250)	2	457	(1,500)	3
103,6 (340)	381	(1,250)	2	457	(1,500)	3
106,7 (350)	381	(1,250)	2	457	(1,500)	2
109,7 (360)	381	(1,250)	2	457	(1,500)	2
112,8 (370)	381	(1,250)	2	457	(1,500)	2

NOTE: Line lengths given in table will allow hook to touch ground. When block travel below ground is required, add additional rope equal to parts of line times added travel distance. Hoisting distance or line pull may be limited when block travel below ground is required.

Front and rear drums each provide 131 kN (29,500 lb) maximum single line pull.
Auxiliary drum provides 89 kN (20,000 lb) maximum single line pull.

Wire rope lengths Fixed jib No. 138 on luffing jib No. 135 on boom No. 82 or No. 22EL		
Boom, luffing jib, and fixed jib length	Whip line Front or aux drum (1 part of line)	
	m	(ft)
100,6 (330)	210	(690)
103,6 (340)	216	(710)
106,7 (350)	223	(730)
109,7 (360)	229	(750)
112,8 (370)	235	(770)
115,8 (380)	241	(790)
118,9 (390)	247	(810)
121,9 (400)	253	(830)
125,0 (410)	259	(850)
128,0 (420)	265	(870)
131,1 (430)	271	(890)

NOTE: Line lengths given in table will allow hook to touch ground. When block travel below ground is required, add additional rope equal to parts of line times added travel distance. Hoisting distance or line pull may be limited when block travel below ground is required.

Front and rear drums each provide 131 kN (29,500 lb) maximum single line pull.
Auxiliary drum provides 89 kN (20,000 lb) maximum single line pull.



Performance data

Wire rope lengths Boom No. 82LR - or - Fixed jib No. 134 or No. 123 on boom No. 82LR							
Boom or boom and fixed jib length	Whip line				Hoist line		
	Front or aux drum (1 part of line)		Front or aux drum (2 parts of line)		Rear drum	Maximum required parts of line	
	m	(ft)	m	(ft)			m
36,6 (120)	85	(280)	—	—	396	(1,300)	9
39,6 (130)	91	(300)	—	—	427	(1,400)	9
42,7 (140)	98	(320)	—	—	457	(1,500)	9
45,7 (150)	104	(340)	152	(500)	488	(1,600)	9
48,8 (160)	110	(360)	162	(530)	488	(1,600)	8
51,8 (170)	116	(380)	171	(560)	495	(1,625)	8
54,9 (180)	122	(400)	180	(590)	495	(1,625)	7
57,9 (190)	128	(420)	189	(620)	495	(1,625)	7
61,0 (200)	134	(440)	198	(650)	495	(1,625)	6
64,0 (210)	140	(460)	207	(680)	495	(1,625)	6
67,1 (220)	146	(480)	216	(710)	495	(1,625)	6
70,1 (230)	152	(500)	226	(740)	495	(1,625)	5
73,2 (240)	158	(520)	235	(770)	495	(1,625)	5
76,2 (250)	165	(540)	244	(800)	495	(1,625)	4
79,2 (260)	171	(560)	253	(830)	495	(1,625)	4
82,3 (270)	177	(580)	262	(860)	495	(1,625)	4
85,3 (280)	183	(600)	271	(890)	495	(1,625)	3
88,4 (290)	189	(620)	280	(920)	495	(1,625)	3
91,4 (300)	195	(640)	290	(950)	495	(1,625)	3
94,5 (310)	201	(660)	299	(980)	495	(1,625)	3
97,5 (320)	207	(680)	308	(1,010)	495	(1,625)	3
100,6 (330)	213	(700)	317	(1,040)	495	(1,625)	2
103,6 (340)	219	(720)	326	(1,070)	495	(1,625)	2
106,7 (350)	226	(740)	335	(1,100)	—	—	—
109,7 (360)	232	(760)	344	(1,130)	—	—	—
112,8 (370)	238	(780)	—	—	—	—	—
115,8 (380)	244	(800)	—	—	—	—	—

NOTE: Line lengths given in table will allow hook to touch ground. When block travel below ground is required, add additional rope equal to parts of line times added travel distance. Hoisting distance or line pull may be limited when block travel below ground is required.

Front and rear drums each provide 131 kN (29,500 lb) maximum single line pull.
Auxiliary drum provides 89 kN (20,000 lb) maximum single line pull.



Performance data

Wire rope lengths Boom No. 22E with open throat top - or - Fixed jib No. 123 on boom No. 22E with open throat top												
Boom or boom and fixed jib length m (ft)	Whip line				Hoist line				Auxiliary Hoist line			
	Rear drum (1 part of line)		Rear drum (2 parts of line)		Front drum		Maximum required parts of line		Auxiliary drum		Maximum required parts of line	
	m	(ft)	m	(ft)	m	(ft)	Inline	Offset	m	(ft)	Inline	Offset
21,3 (70)	55	(180)	79	(260)	351	(1,150)	14	14	—	—	—	—
24,4 (80)	61	(200)	88	(290)	396	(1,300)	14	12	396	(1,300)	14	14
27,4 (90)	67	(220)	98	(320)	411	(1,350)	13	11	442	(1,450)	14	14
30,5 (100)	73	(240)	107	(350)	457	(1,500)	13	10	488	(1,600)	14	14
33,5 (110)	79	(260)	116	(380)	457	(1,500)	11	10	533	(1,750)	14	14
36,6 (120)	85	(280)	125	(410)	465	(1,525)	11	9	579	(1,900)	14	13
39,6 (130)	91	(300)	134	(440)	465	(1,525)	10	8	625	(2,050)	14	12
42,7 (140)	98	(320)	143	(470)	465	(1,525)	9	8	671	(2,200)	14	12
45,7 (150)	104	(340)	152	(500)	480	(1,575)	9	8	671	(2,200)	13	11
48,8 (160)	110	(360)	162	(530)	480	(1,575)	8	8	671	(2,200)	12	11
51,8 (170)	116	(380)	171	(560)	488	(1,600)	8	7	671	(2,200)	11	10
54,9 (180)	122	(400)	180	(590)	488	(1,600)	7	7	671	(2,200)	10	10
57,9 (190)	128	(420)	189	(620)	488	(1,600)	7	6	671	(2,200)	10	9
61,0 (200)	134	(440)	198	(650)	488	(1,600)	6	6	671	(2,200)	9	9
64,0 (210)	140	(460)	207	(680)	488	(1,600)	6	6	671	(2,200)	8	8
67,1 (220)	146	(480)	216	(710)	488	(1,600)	6	5	671	(2,200)	8	8
70,1 (230)	152	(500)	226	(740)	488	(1,600)	5	5	671	(2,200)	7	7
73,2 (240)	158	(520)	235	(770)	488	(1,600)	5	4	671	(2,200)	7	6
76,2 (250)	165	(540)	244	(800)	488	(1,600)	4	4	671	(2,200)	6	6
79,2 (260)	171	(560)	253	(830)	488	(1,600)	4	4	671	(2,200)	6	5
82,3 (270)	177	(580)	262	(860)	488	(1,600)	4	3	671	(2,200)	5	5
85,3 (280)	183	(600)	271	(890)	488	(1,600)	3	3	671	(2,200)	5	4
88,4 (290)	189	(620)	280	(920)	488	(1,600)	3	3	671	(2,200)	4	4
91,4 (300)	195	(640)	290	(950)	—	—	—	—	—	—	—	—
94,5 (310)	201	(660)	—	—	—	—	—	—	—	—	—	—
97,5 (320)	207	(680)	—	—	—	—	—	—	—	—	—	—

NOTE: Line lengths given in table will allow hook to touch ground. When block travel below ground is required, add additional rope equal to parts of line times added travel distance. Hoisting distance or line pull may be limited when block travel below ground is required.

Front and rear drums each provide 131 kN (29,500 lb) maximum single line pull.

Auxiliary drum provides 89 kN (20,000 lb) maximum single line pull.

*Wire rope lengths greater than 625 m (2,050') cannot be stored on auxiliary drum. Auxiliary drum cannot be used with 21,3 m (70') boom. Capacity chart restrictions will occur when auxiliary drum is used. Auxiliary drum maximum capacity is 127 010 kg (280,000 lb) with 14 parts line.



Performance data

Wire rope lengths Boom No. 22E with light tapered top - or - No. 123 Fixed jib on Boom No. 22E with light tapered top							
Boom or boom and fixed jib length	Whip line				Hoist line		
	Rear or aux drum (1 part of line)		Rear or aux drum (2 parts of line)		Front drum		Maximum required parts of line
	m	(ft)	m	(ft)	m	(ft)	
33,5 (110)	79	(260)	116	(380)	358	(1,175)	9
36,6 (120)	85	(280)	125	(410)	389	(1,275)	9
39,6 (130)	91	(300)	134	(440)	419	(1,375)	9
42,7 (140)	98	(320)	143	(470)	450	(1,475)	9
45,7 (150)	104	(340)	152	(500)	450	(1,475)	8
48,8 (160)	110	(360)	162	(530)	457	(1,500)	8
51,8 (170)	116	(380)	171	(560)	457	(1,500)	7
54,9 (180)	122	(400)	180	(590)	457	(1,500)	7
57,9 (190)	128	(420)	189	(620)	457	(1,500)	6
61,0 (200)	134	(440)	198	(650)	457	(1,500)	6
64,0 (210)	140	(460)	207	(680)	465	(1,525)	6
67,1 (220)	146	(480)	216	(710)	465	(1,525)	5
70,1 (230)	152	(500)	226	(740)	465	(1,525)	5
73,2 (240)	158	(520)	235	(770)	495	(1,525)	5
76,2 (250)	165	(540)	244	(800)	465	(1,525)	4
79,2 (260)	171	(560)	253	(830)	465	(1,525)	4
82,3 (270)	177	(580)	262	(860)	465	(1,525)	4
85,3 (280)	183	(600)	271	(890)	465	(1,525)	3
88,4 (290)	189	(620)	280	(920)	465	(1,525)	3
91,4 (300)	195	(640)	290	(950)	495	(1,525)	3
94,5 (310)	201	(660)	299	(980)	465	(1,525)	3
97,5 (320)	207	(680)	308	(1,010)	—	—	—
100,6 (330)	213	(700)	317	(1,040)	—	—	—
103,6 (340)	219	(720)	—	—	—	—	—
106,7 (350)	226	(740)	—	—	—	—	—

NOTE: Line lengths given in table will allow hook to touch ground. When block travel below ground is required, add additional rope equal to parts of line times added travel distance. Hoisting distance or line pull may be limited when block travel below ground is required.

Front and rear drums each provide 131 kN (29,500 lb) maximum single line pull.
Auxiliary drum provides 89 kN (20,000 lb) maximum single line pull.



Performance data

Wire rope specifications 5:1 safety factor
Boom No. 82 or No. 22EL or
Boom No. 82 with No. 82 long reach rop or
Boom No. 22E with open throat top or
Boom No. 22E with light tapered top
 - or -
Fixed jib No. 134 on boom No. 82 or No. 22EL or
Fixed jib No. 134 on boom No. 82LR or
Fixed jib No. 123 on boom No. 82 with long reach top or
Fixed jib No. 123 on boom No. 22E with open throat top or
Fixed jib No. 123 on boom No. 22E with light tapered top

Function	5:1 Safety factor Rotation resistant, 2 160 N/mm ² Wire rope with pad eye			5:1 Safety factor Rotation resistant, 1 960 N/mm ² Wire rope	
	Hoist line	Whip line	Maximum capacity hoist line	Auxiliary line	
Part number	No. 719431	No. 719431 No. 719430 No. 719432	No. 719430 No. 719432	No. 719378 No. 719434	No. 719393
Size wire rope	26 mm	26 mm	26 mm	26mm	— (1")
Minimum breaking strength	656,1 kN (147,500 lb)	656,1 kN (147,500 lb)	695,3 kN (156,250 lb)	445,0 kN (100,000 lb)	445,0 kN (100,000 lb)
Maximum load per line	13 380 kg (29,500 lb)	13 380 kg (29,500 lb)	14 175 kg (31,250 lb)	9 070 kg (20,000 lb)	9 070 kg (20,000 lb)
Approximate weight	3,39 kg/m (2.28 lb/ft)	3,39 kg/m (2.28 lb/ft)	3,56 kg/m (2.39 lb/ft)	3,17 kg/m (2.13 lb/ft)	3,02 kg/m (2.03 lb/ft)

Wire rope specifications 3.5:1 safety factor
Boom No. 82 or No. 22EL or
Boom No. 82 with No. 82 long reach top or
Boom No. 22E with open throat top or
Boom No. 22E with light tapered top
 - or -
Fixed jib No. 134 on boom No. 82 or No. 22EL or
Fixed jib No. 134 on boom No. 82LR or
Fixed jib No. 123 on boom No. 82 with long reach top or
Fixed jib No. 123 on boom No. 22E with open throat top or
Fixed jib No. 123 on boom No. 22E with light tapered top

Function	3.5:1 Safety factor 6 x 25 Filler wire, EIPS Right regular lay, IWRC			Auxiliary line	
	Hoist line	Whip line	Maximum capacity hoist line		
Part number	No. 719387	No. 719387	No. 719383*	No. 719387	No. 719433**
Size wire rope	26 mm	26 mm	26 mm	26mm	— (1")
Minimum breaking strength	459,5 kN (103,250 lb)	459,5 kN (103,250 lb)	536,1 kN (119,400 lb)	311,5 kN (70,000 lb)	311,5 kN (70,000 lb)
Maximum load per line	13 380 kg (29,500 lb)	13 380 kg (29,500 lb)	14 175 kg (31,250 lb)	9 070 kg (20,000 lb)	9 070 kg (20,000 lb)
Approximate weight	2,89 kg/m (1.94 lb/ft)	2,89 kg/m (1.94 lb/ft)	2,89 kg/m (1.94 lb/ft)	2,89 kg/m (1.94 lb/ft)	2,75 kg/m (1.85 lb/ft)

* EEIPS wire rope
 ** IPS wire rope



Performance data

Wire rope specifications 5:1 safety factor

No. 138 Fixed jib on
No. 135 Luffing jib on
Boom No. 82 or No. 22EL
- or -
No. 134 Fixed jib on
No. 149 Luffing jib on
boom No. 82

Function	5:1 Safety factor Rotation resistant 2 160 N/mm ² Wire rope with pad eye	5:1 Safety factor Rotation resistant 1 960 N/mm ² Wire rope	
	Whip line	Auxiliary drum whip line	
Part number	No. 719431	No. 719378 No. 719434	No. 719393
Size wire rope	26 mm —	26mm —	— (1")
Minimum breaking strength	656,1 kN (147,500 lb)	445,0 kN (100,000 lb)	445,0 kN (100,000 lb)
Maximum load per line	13 380 kg (29,500 lb)	9 070 kg (20,000 lb)	9 070 kg (20,000 lb)
Approximate weight	3,39 kg/m (2.28 lb/ft)	3,17 kg/m (2.13 lb/ft)	3,02 kg/m (2.03 lb/ft)

* 12 474 kg (27,500 lb) for No. 138 Fixed jib extension

Wire rope specifications 3.5:1 safety factor

No. 138 Fixed jib on
No. 135 Luffing jib on
Boom No. 82 or No. 22EL
- or -
No. 134 Fixed jib on
No. 149 Luffing jib on
boom No. 82

Function	3.5:1 Safety factor 6 x 25 Filler wire, EIPS Right regular lay, IWRC	3.5:1 Safety factor 6 x 25 Filler wire, EIPS Right regular lay, IWRC	
	Whip line	Auxiliary line	
Part number	No. 719387	No. 719387	No. 719433**
Size wire rope	26 mm —	26mm —	— (1")
Minimum breaking strength	459,5 kN (103,250 lb)	311,5 kN (70,000 lb)	311,5 kN (70,000 lb)
Maximum load per line	13 380 kg (29,500 lb)	9 070 kg (20,000 lb)	9 070 kg (20,000 lb)
Approximate weight	2,89 kg/m (1.94 lb/ft)	2,89 kg/m (1.94 lb/ft)	2,75 kg/m (1.85 lb/ft)

** 12 474 kg (27,500 lb) for No. 138 Fixed jib extension.

**IPS wire rope



Performance data

Main & whip drums - 131 kN (29,500 lb)							
Line pull kg (lb)	Full power drum - continuous duty Single line pull/single line speed						
	m/min (ft/min)						
	1	2	3	4	5	6	7
0 (0)	87 (285)	95 (310)	102 (335)	110 (360)	119 (390)	127 (415)	134 (440)
2 268 (5,000)	82 (270)	90 (295)	98 (320)	105 (345)	111 (365)	119 (390)	127 (415)
4 536 (10,000)	79 (260)	87 (285)	93 (305)	99 (325)	105 (345)	111 (365)	117 (385)
6 803 (15,000)	76 (250)	82 (270)	88 (290)	93 (305)	96 (315)	98 (320)	99 (325)
9 072 (20,000)	72 (235)	73 (240)	75 (245)	76 (250)	78 (255)	79 (260)	81 (265)
11 340 (25,000)	61 (200)	63 (205)	64 (210)	66 (215)	67 (220)	69 (225)	70 (230)
13 380 (29,500)	53 (175)	55 (180)	56 (185)	58 (190)	59 (195)	61 (200)	63 (205)

NOTE: Line pull is infinitely variable.

Auxiliary drum - 89,0 kN (20,000 lb)			
Line pull kg (lb)	Full power drum - continuous duty Single line pull/single line speed		
	m/min (ft/min)		
	1	4	6
0 (0)	116 (380)	146 (480)	168 (550)
2 268 (5,000)	0110 (360)	137 (450)	156 (510)
4 536 (10,000)	104 (340)	128 (420)	143 (470)
6 803 (15,000)	95 (310)	98 (320)	98 (320)
9 072 (20,000)	73 (240)	76 (250)	82 (270)

NOTE: Line pull is infinitely variable.

Drum capacities - wire rope		
	Maximum length	
	No lagging	With lagging
Front or rear grooved drum 26 mm wire rope*	526 m (1,727 ft) 7 Layers	— —
Auxiliary drum 26 mm wire rope*	403 m (1,323 ft) 6 Layers	431 m (1,415 ft) 6 Layers
Auxiliary drum (1") wire rope*	407 m (1,335 ft) 6 Layers	435 m (1,428 ft) 6 Layers
Boom hoist drum 22,23 mm (7/8") wire rope	323 m (1,060 ft) 6 Layers	— —

*5 m (17') is deducted from maximum spooling capacities for 3 dead wraps per drum or lagging.

Working weight			
Configuration	kg (lb)		
	Series 1	Series 2	Series 3
21,3 m (70') No. 82 Boom	161 081 (355,124)	196 924 (434,144)	229 138 (505,164)
76,2 m (250') No. 82 Boom combined with 24,4 m (80') No. 134 Fixed jib	— —	210 026 (463,028)	242 240 (534,048)
61,0 m (200') No. 82 Boom combined with 51,8 m (170') No. 135 Luffing jib	177 973* (392,364)*	216 074** (476,362)**	248 711 (548,315)

Typical working weight includes optional self-assembly carbody jacks, hydraulic reservoir full, fuel half-full, drums with standard lengths of wire rope, upper boom point, 227 mt (250 t) hook block, and 13,6 mt (15 t) hook and weight ball.

Note: Upper boom point not used with fixed jib or luffing jib.

*48,8 m (160') No. 82 boom maximum allowed.

**57,9 m (190') No. 82 boom maximum allowed



Performance data

Maximum length – unassisted raising

Over end of blocked crawlers or side of crawlers m (ft)	No. 82 or No. 22EL Main boom - or - No. 134 Fixed jib on No. 82 or No. 22EL Main boom Series 3	
	Main boom	Fixed jib
88,4 (290)	—	—
85,3 (280)	—	—
82,3 (270)	9,1 (30)	—
79,2 (260)	18,3 (60)	—
76,2 (250)	24,4 (80)	—

NOTE: Load block(s), hook(s) and weight ball(s) on ground at start. Upper boom point cannot be used on 88,4 m (290') boom, or when jib is attached.

Boom lengths of 76,2 m (250') through 88,4 m (290') require only two middle sheaves in lower boom point, all others must be removed from lower boom point.

Maximum length – unassisted raising

Over end of blocked crawlers m (ft)	No. 134 Fixed jib on No. 149 Luffing jib on No. 82 Main boom Series 3		
	Layout jack-knife method		
	Main boom	Luffing jib	Fixed jib
57,9* (190)*	61,0 - 64,0 (200 - 210)	9,1 - 24,4 (30 - 80)	—
61,0* (200)	51,8 (170)	9,1 - 24,4 (30 - 80)	—

NOTE: Load block(s), hook(s) and weight ball(s) on ground at start.

#Without intermediate fall.

*Requires lower boom point to be removed.

Maximum length – unassisted raising

Over end of blocked crawlers m (ft)	No. 149 Luffing jib on No. 82 Main boom Series 3			
	Layout Jack-knife method			
	Main boom	Luffing jib**	Main boom	Luffing jib***
24,4 (80)	51,8 - 73,2 (170 - 240)	24,4 (80)	54,9 - 73,2 (180 - 240)	—
27,4 (90)	48,8 - 73,2 (160 - 240)	27,4 (90)	51,8 - 73,2 (170 - 240)	—
30,5 (100)	42,7 - 73,2 (140 - 240)	30,5 (100)	48,8 - 73,2 (160 - 240)	—
33,5 (110)	39,6 - 73,2 (130 - 240)	33,5 (110)	42,7 - 73,2 (140 - 240)	—
36,6 (120)	36,6 - 73,2 (120 - 240)	36,6 (120)	39,6 - 73,2 (130 - 240)	—
39,6 (130)	30,5 - 73,2 (100 - 240)	39,6 (130)	36,6 - 73,2 (120 - 240)	—
42,7 (140)	27,4 - 73,2 (90 - 240)	42,7 (140)	30,5 - 73,2 (100 - 240)	—
45,7 (150)	21,3 - 73,2 (70 - 240)	45,7 (150)	24,4 - 73,2 (80 - 240)	—
48,8 (160)	21,3 - 73,2 (70 - 240)	48,8 (160)	21,3 - 73,2 (70 - 240)	—
51,8 (170)	21,3 - 73,2 (70 - 240)	51,8 (170)	21,3 - 73,2 (70 - 240)	—
54,9 (180)	21,3 - 64,0 (70 - 210)	54,9 (180)	21,3 - 70,1 (70 - 230)	—
57,9# (190) #	21,3 - 54,9 (70 - 180)	57,9# (190) #	21,3 - 57,9 (70 - 190)	—
61,0* (200) *	21,3 - 39,6 (70 - 130)	61,0* (200) *	21,3 - 51,8 (70 - 170)	—

NOTE: Load block(s), hook(s) and weight ball(s) on ground at start.

#Requires only two middle sheaves in lower boom point, all others must be removed from lower boom point.

*Requires lower boom point to be removed.

**With intermediate fall.

***Without intermediate fall.



Performance data

Maximum length – unassisted raising				
Over end of blocked crawlers m (ft)	No. 138 Fixed jib on No. 135 Luffing jib on No. 82 or No. 22EL Main boom Series 3			
	Main boom	Fixed jib	Layout jack-knife method luffing jib	Fold under jack-knife method luffing jib
	48,8 (160)	9,1 - 18,3 (30 - 60)	42,7 - 51,8 (140 - 170)	42,7 (140)
	51,8 (170)	9,1 - 18,3 (30 - 60)	42,7 - 51,8 (140 - 170)	42,7 - 45,7 (140 - 150)
	54,9 (180)	9,1 - 18,3 (30 - 60)	42,7 - 51,8 (140 - 170)	42,7 - 48,8 (140 - 160)
	57,9# (190)#	9,1 - 18,3 (30 - 60)	42,7 - 51,8 (140 - 170)	42,7 - 51,8 (140 - 170)
61,0* (200)*	9,1 - 18,3 (30 - 60)	42,7 - 51,8 (140 - 170)	42,7 - 51,8 (140 - 170)	

NOTE: Load block(s), hook(s) and weight ball(s) on ground at start.
 #Requires only two middle sheaves in lower boom point, all others must be removed from lower boom point.
 *Lower boom point must be removed

Maximum length – unassisted raising						
Over end of blocked crawlers m (ft)	No. 135 Luffing jib on No. 82 or No. 22EL Main boom Series 3					
	Layout inline method		Layout jack-knife method		Fold under jack-knife method	
	Main boom	Luffing jib	Main boom	Luffing jib	Main boom	Luffing jib
	21,3 (70)	21,3 - 51,8 (70 - 170)	39,6 (130)	51,8 (170)	27,4 (90)	21,3 (70)
	24,4 (80)	21,3 - 51,8 (70 - 170)	42,7 (140)	48,8 - 51,8 (160 - 170)	30,5 (100)	21,3 - 24,4 (70 - 80)
	27,4 (90)	21,3 - 51,8 (70 - 170)	45,7 (150)	39,6 - 51,8 (130 - 170)	33,5 (110)	21,3 - 27,4 (70 - 90)
	30,5 (100)	21,3 - 51,8 (70 - 170)	48,8 (160)	33,5 - 51,8 (110 - 170)	36,6 (120)	21,3 - 30,5 (70 - 100)
	33,5 (110)	21,3 - 51,8 (70 - 170)	51,8 (170)	27,4 - 51,8 (90 - 170)	39,6 (130)	21,3 - 33,5 (70 - 110)
	36,6 (120)	21,3 - 51,8 (70 - 170)	54,9 (180)	21,3 - 51,8 (70 - 170)	42,7 (140)	21,3 - 36,6 (70 - 120)
	39,6 (130)	21,3 - 48,8 (70 - 160)	57,9# (190) #	21,3 - 51,8 (70 - 170)	45,7 (150)	21,3 - 39,6 (70 - 130)
42,7 (140)	21,3 - 45,7 (70 - 150)	61,0* (200) *	21,3 - 51,8 (70 - 170)	48,8 (160)	21,3 - 42,7 (70 - 140)	
45,7 (150)	21,3 - 36,6 (70 - 120)			51,8 (170)	21,3 - 45,7 (70 - 150)	
48,8 (160)	21,3 - 30,5 (70 - 100)			54,9 (180)	21,3 - 48,8 (70 - 160)	
51,8 (170)	21,3 - 24,4 (70 - 80)			57,9# (190)#	21,3 - 51,8 (70 - 170)	
				61,0* (200)*	21,3 - 51,8 (70 - 170)	

NOTE: Load block(s), hook(s) and weight ball(s) on ground at start.
 #Requires only two middle sheaves in lower boom point, all others must be removed from lower boom point.
 *Lower boom point must be removed.



Performance data

Maximum length – unassisted raising

Over end of blocked crawlers m (ft)	No. 82LR Boom - or - No. 134 Fixed jib on No. 82LR Boom Series 3	
	Main boom	Fixed jib
	103,6 (340)	— —
91,4 (300)	24,4 (80)	

NOTE: Load block(s), hook(s) and weight ball(s) on ground at start. Upper boom point cannot be used when jib is attached. Upper boom point cannot be used on 103,6 m (340') boom.

Maximum length – unassisted raising

Over end of blocked crawlers m (ft)	No. 82LR Boom - or - No. 123 Fixed jib on No. 82LR Boom Series 3	
	Main boom	Fixed jib
	103,6 (340)	— —
91,4 (300)	18,3 (6)	

NOTE: Load block(s), hook(s) and weight ball(s) on ground at start. Upper boom point cannot be used when jib is attached. Upper boom point cannot be used on 103,6 m (340') boom.

Maximum length – unassisted raising

Over end of blocked crawlers m (ft)	No.22E Boom with light tapered top - or - No. 123 Fixed jib on No.22E Boom with light tapered top Series 3	
	Main boom	Fixed jib
	94,5 (310)	— —
	91,4 (300)	9,1 (30)
88,4 (290)	18,3 (60)	

NOTE: Load block(s), hook(s) and weight ball(s) on ground at start. Upper boom point cannot be used when jib is attached. Upper boom point cannot be used on 94,5 m (310') boom.

Maximum length – unassisted raising

Over end of blocked crawlers m (ft)	No.22E Boom with open throat top - or - No. 123 Fixed jib on No.22E Boom with open throat top Series 3	
	Main boom	Fixed jib
	88,4 (290)	— —
	85,3 (280)	— —
	82,3 (270)	9,1 (30)
79,2 (260)	18,3 (60)	

NOTE: Load block(s), hook(s) and weight ball(s) on ground at start. Upper boom point cannot be used when jib is attached. Upper boom point cannot be used on 88,4 m (290') boom.

Main boom attachments

Main boom (with top)	Fixed jib	Luffing jib	Fixed jib (extension)
No. 82* (Heavy-lift)	No. 134	No. 149* No. 135	No. 134 No. 138
No. 82LR* (Long-reach top)	No. 134 No. 123		
No. 22EL (Heavy-lift)	No. 134	No. 135	No. 138
No. 22E (Open throat top)	No. 123		
No. 22E (Light tapered top)	No. 123		

*Use straps and FACT™ connections. All others use pendants and pinned connections.



Boom combinations

No. 82 or No. 22EL Boom combinations			
Boom Length m (ft)	Boom Inserts		
	3,0 m (10 ft)	6,1 m (20 ft)	12,2 m (40 ft)
21,3 (70)	—	—	—
24,4 (80)	1	—	—
27,4 (90)	—	1	—
30,5 (100)	1	1	—
33,5 (110)	—	—	1
36,6 (120)	1	—	1
39,6 (130)	—	1	1
42,7 (140)	1	1	1
45,7 (150)	—	—	2
48,8 (160)	1	—	2
51,8 (170)	—	1	2
54,9 (180)	1	1	2
57,9 (190)	—	—	3
61,0 (200)	1	—	3
64,0 (210)	—	1	3
67,1 (220)	1	1	3
70,1 (230)	—	—	4
73,2 (240)	1	—	4
76,2 (250)	—	1	4
79,2 (260)	1	1	4
82,3 (270)	—	—	5
85,3 (280)	1	—	5
88,4 (290)	—	1	5

No. 134 Fixed jib combinations		
Jib Length m (ft)	Fixed Jib Inserts	
	3,0 m (10 ft)	6,1 m (20 ft)
9,1 (30)	—	—
12,2 (40)	1	—
15,2 (50)	—	1
18,3 (60)	1	1
21,3 (70)	—	2
24,4 (80)	1	2

Note: Can be used as fixed jib extension for No. 149 luffing jib.

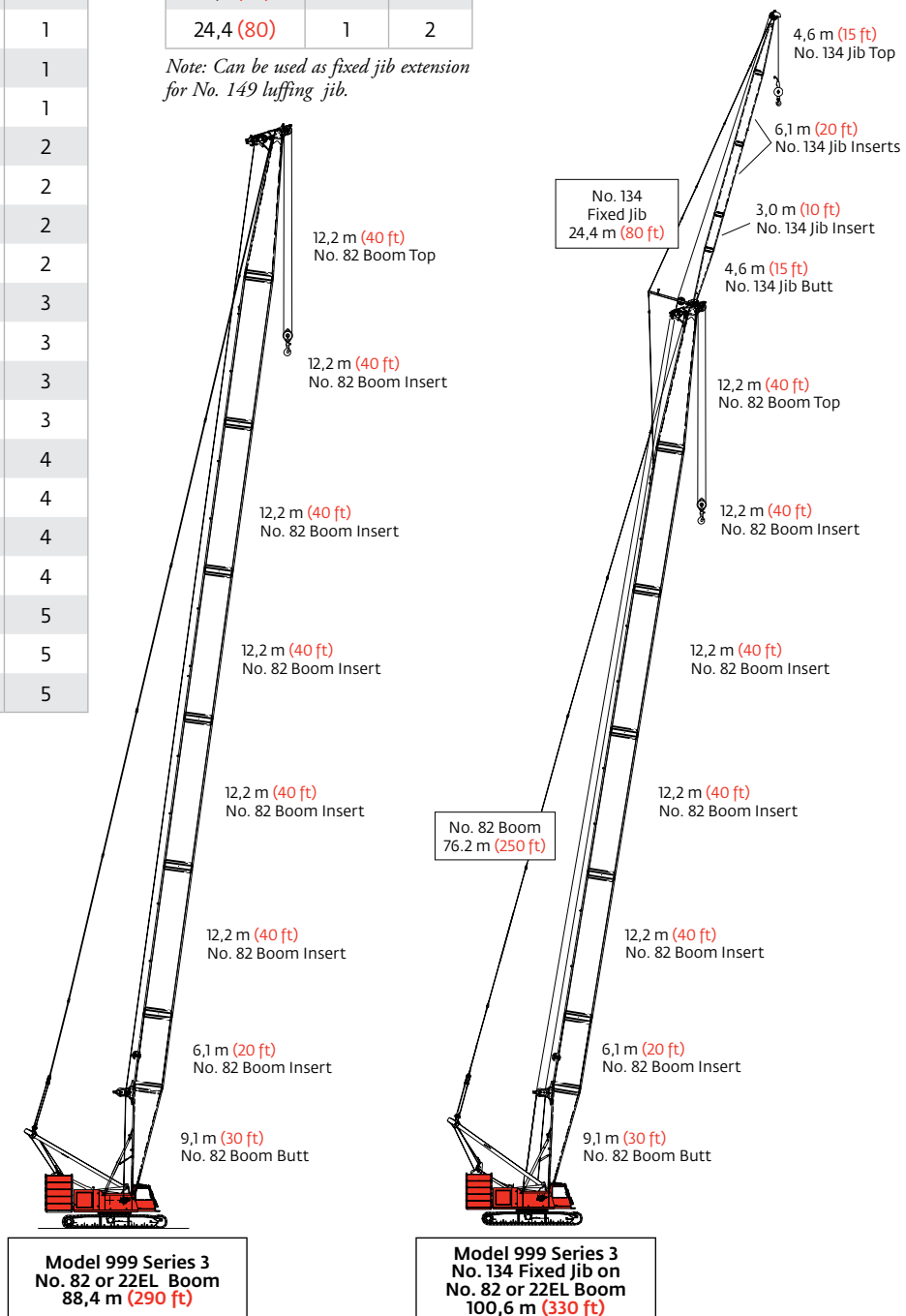



Boom combinations

No. 82LR Boom combinations				
Boom Length m (ft)	Boom Inserts			
	3,0 m (10 ft)	6,1 m (20 ft)	12,2 m (40 ft)	12,2 m* (40 ft)*
36,6 (120)	—	—	1	—
39,6 (130)	1	—	1	—
42,7 (140)	—	1	1	—
45,7 (150)	1	1	1	—
48,8 (160)	—	—	2	—
51,8 (170)	1	—	2	—
54,9 (180)	—	1	2	—
57,9 (190)	1	1	2	—
61,0 (200)	—	—	3	—
64,0 (210)	1	—	3	—
67,1 (220)	—	1	3	—
70,1 (230)	1	1	3	—
73,2 (240)	—	—	4	—
76,2 (250)	1	—	4	—
79,2 (260)	—	1	4	—
82,3 (270)	1	1	4	—
85,3 (280)	—	—	5	—
88,4 (290)	1	—	5	—
91,4 (300)	—	1	5	—
94,5 (310)	1	1	4	1
97,5 (320)	—	—	5	1
100,6 (330)	1	—	5	1
103,6 (340)	—	1	5	1

*Light weight insert

No. 123 Fixed jib combinations		
Jib Length m (ft)	Fixed Jib Inserts	
	3,0 m (10 ft)	6,1 m (20 ft)
9,1 (30)	—	—
12,2 (40)	1	—
15,2 (50)	—	1
18,3 (60)	1	1

Note: No. 123 Fixed Jib can also be used with No. 22E Boom with Open Throat Top or Light Tapered Top.

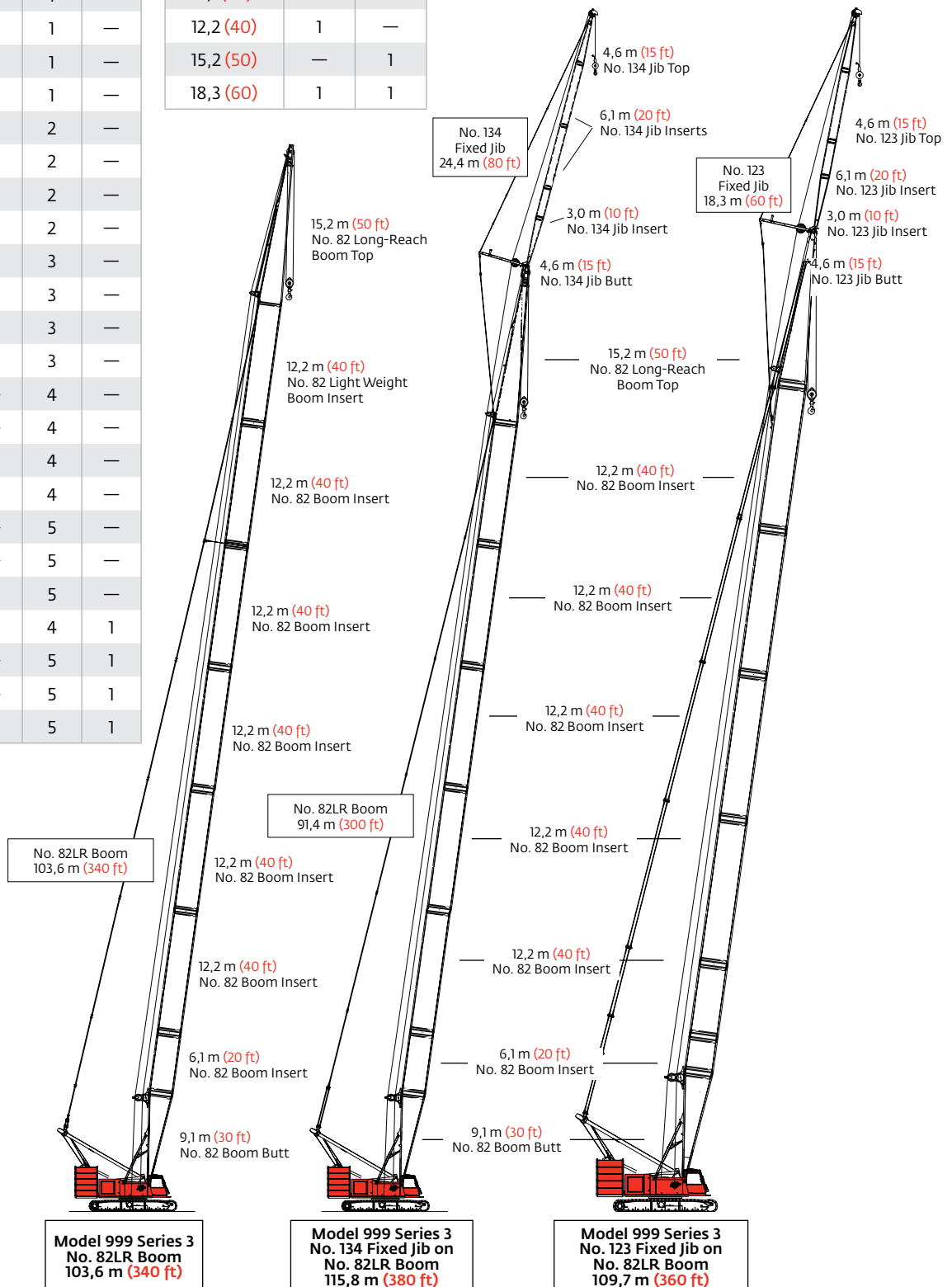



Boom combinations

No. 123 Fixed jib combinations		
Jib Length m (ft)	Fixed Jib Inserts	
	3,0 m (10 ft)	6,1 m (20 ft)
9,1 (30)	—	—
12,2 (40)	1	—
15,2 (50)	—	1
18,3 (60)	1	1

Note: No. 123 Fixed Jib can also be used with No. 82LR Boom.

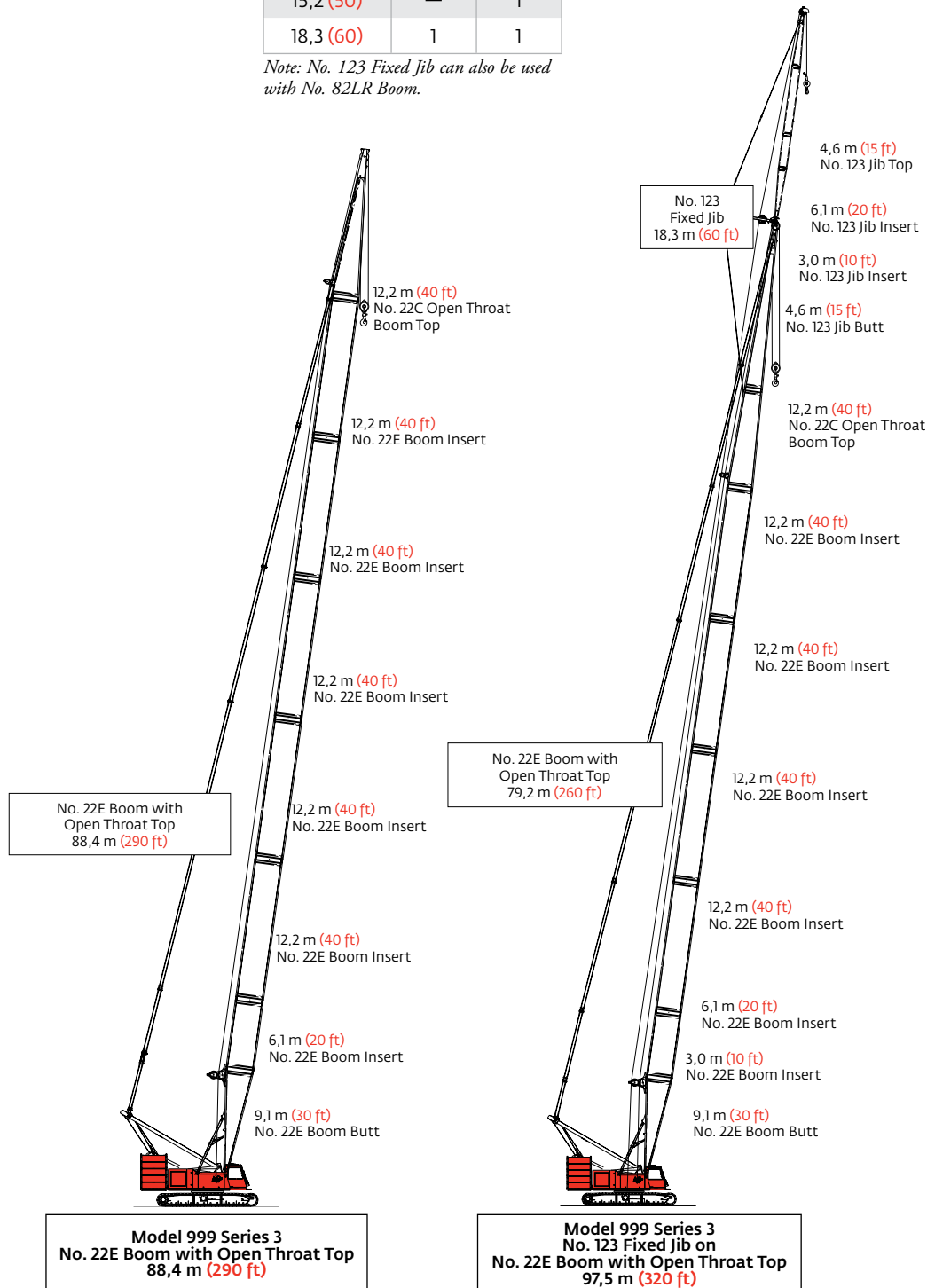



Boom combinations

No. 22E with light tapered top & tapered insert boom combinations

Boom Length m (ft)	Boom Inserts		
	3,0 m (10 ft)	6,1 m (20 ft)	12,2 m (40 ft)
36,6 (120)	1	—	—
39,6 (130)	—	1	—
42,7 (140)	1	1	—
45,7 (150)	—	—	1
48,8 (160)	1	—	1
51,8 (170)	—	1	1
54,9 (180)	1	1	1
57,9 (190)	—	—	2
61,0 (200)	1	—	2
64,0 (210)	—	1	2
67,1 (220)	1	1	2
70,1 (230)	—	—	3
73,2 (240)	1	—	3
76,2 (250)	—	1	3
79,2 (260)	1	1	3
82,3 (270)	—	—	4
85,3 (280)	1	—	4
88,4 (290)	—	1	4
91,4 (300)	1	1	4
94,5 (310)	—	—	5

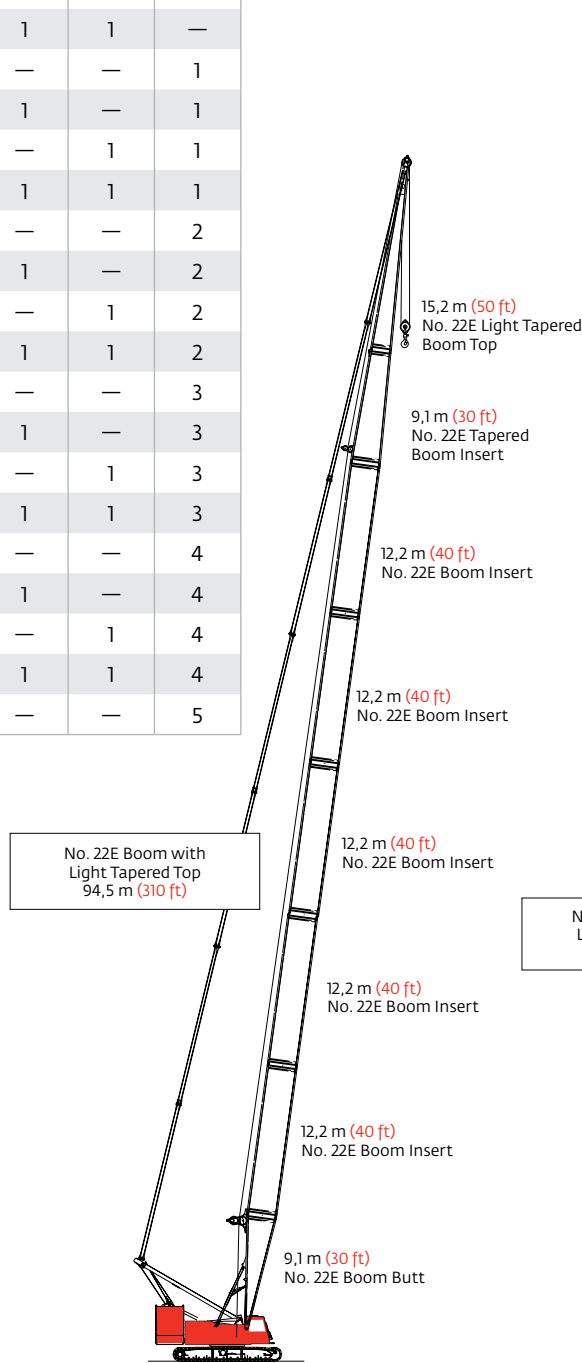

**Model 999 Series 3
No. 22E Boom with Light Tapered Top
94,4 m (310 ft)**

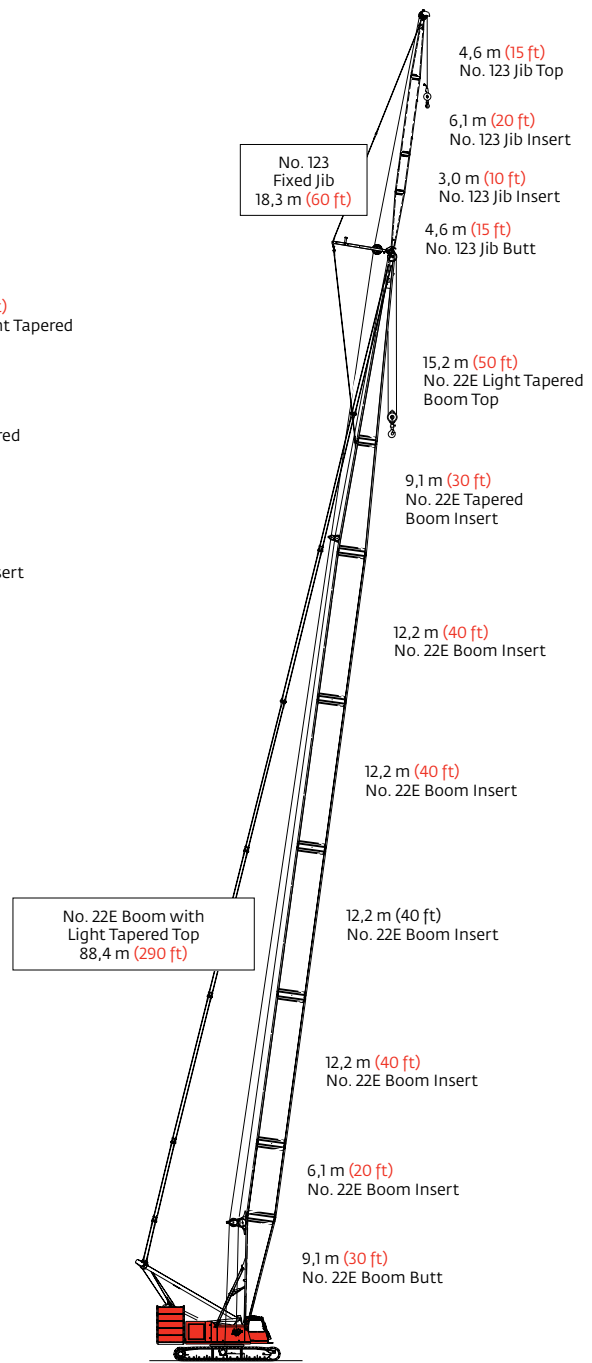

**Model 999 Series 3
No. 123 Fixed Jib on
No. 22E Boom with Light Tapered Top
106,7 m (350 ft)**



Boom combinations

No. 135 Luffing jib combinations

Jib Length m (ft)	Luffing Jib Inserts		
	3,0 m (10 ft)	6,1 m (20 ft)	12,2 m (40 ft)
21,3 (70)	—	1	—
24,4 (80)	1	1	—
27,4 (90)	—	—	1
30,5 (100)	1	—	1
33,5 (110)	—	1	1
36,6 (120)	1	1	1
39,6 (130)	—	—	2
42,7 (140)	1	—	2
45,7 (150)	—	1	2
48,8 (160)	1	1	2
51,8 (170)	0	0	3

No. 138 Fixed jib combinations

Jib Length m (ft)	Fixed Jib Inserts
	3,0 m (10 ft)
9,1 (30)	—
12,2 (40)	1
15,2 (50)	2
18,3 (60)	3

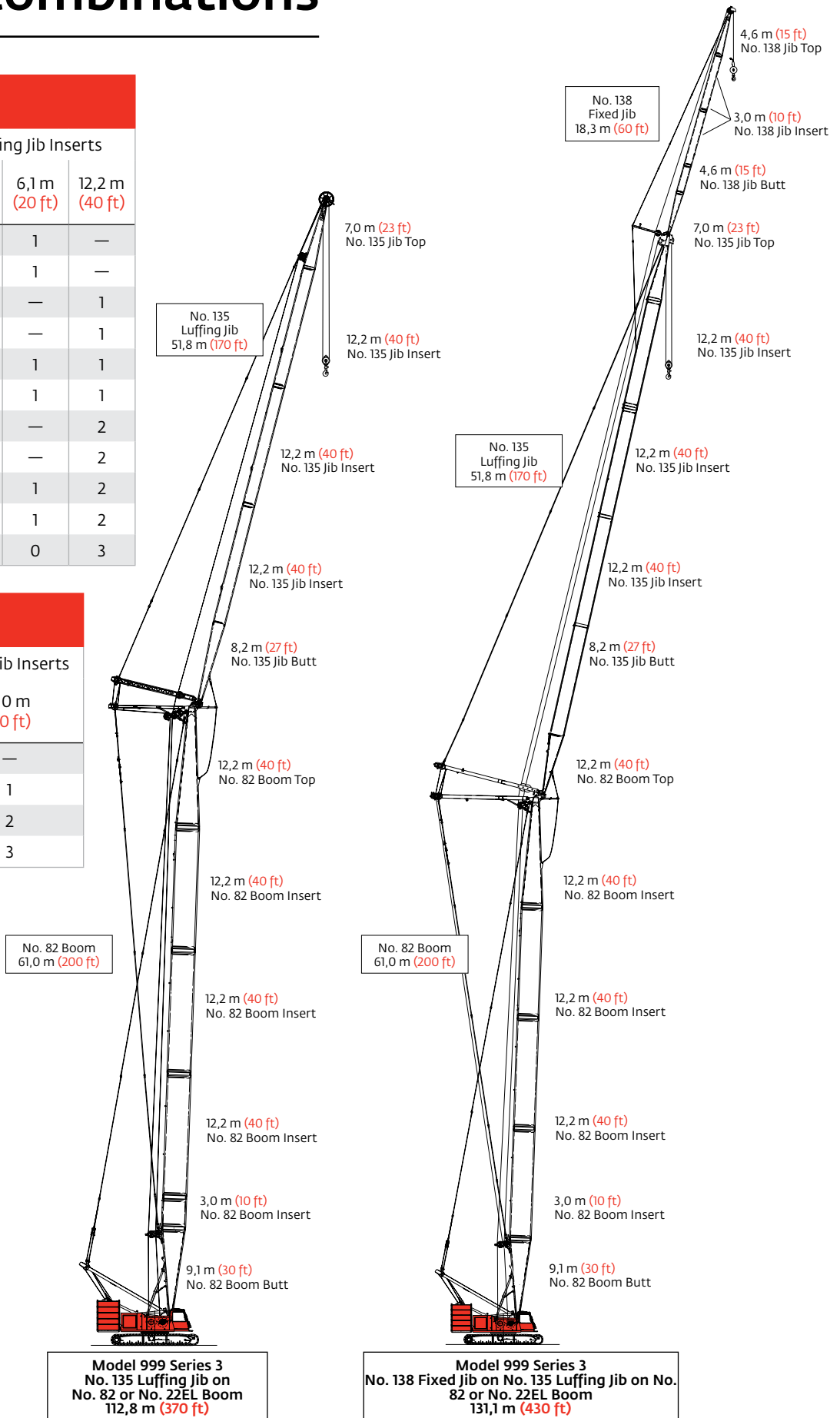



Boom combinations

No. 149 Luffing jib combinations

Jib Length m (ft)	Luffing jib Inserts		
	3,0 m (10 ft)	6,1 m (20 ft)	12,2 m (40 ft)
21,3 (70)	—	1	—
24,4 (80)	1	1	—
27,4 (90)	—	—	1
30,5 (100)	1	—	1
33,5 (110)	—	1	1
36,6 (120)	1	1	1
39,6 (130)	—	—	2
42,7 (140)	1	—	2
45,7 (150)	—	1	2
48,8 (160)	1	1	2
51,8 (170)	—	—	3
54,9 (180)	1	—	3
57,9 (190)	—	1	3
61,0 (200)	1	1	3
64,0 (210)	—	—	4
67,1 (220)	1	—	4
70,1 (230)	—	1	4
73,2 (240)	1	1	4

Note: Optional 6,1 m (20') insert with intermediate fall available for No. 149 luffing jib.

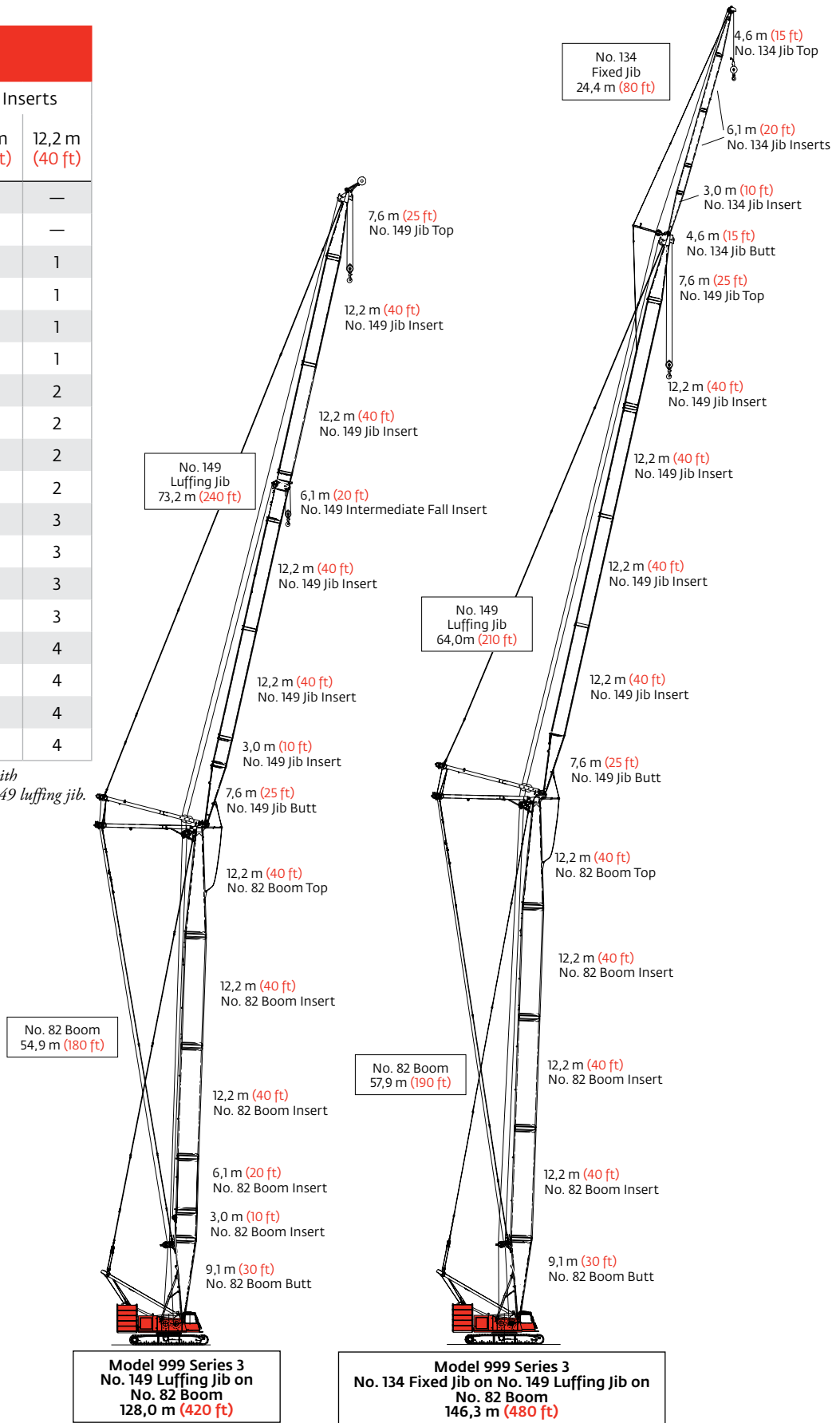



Heavy-lift boom range diagram

No. 82 Long-reach boom

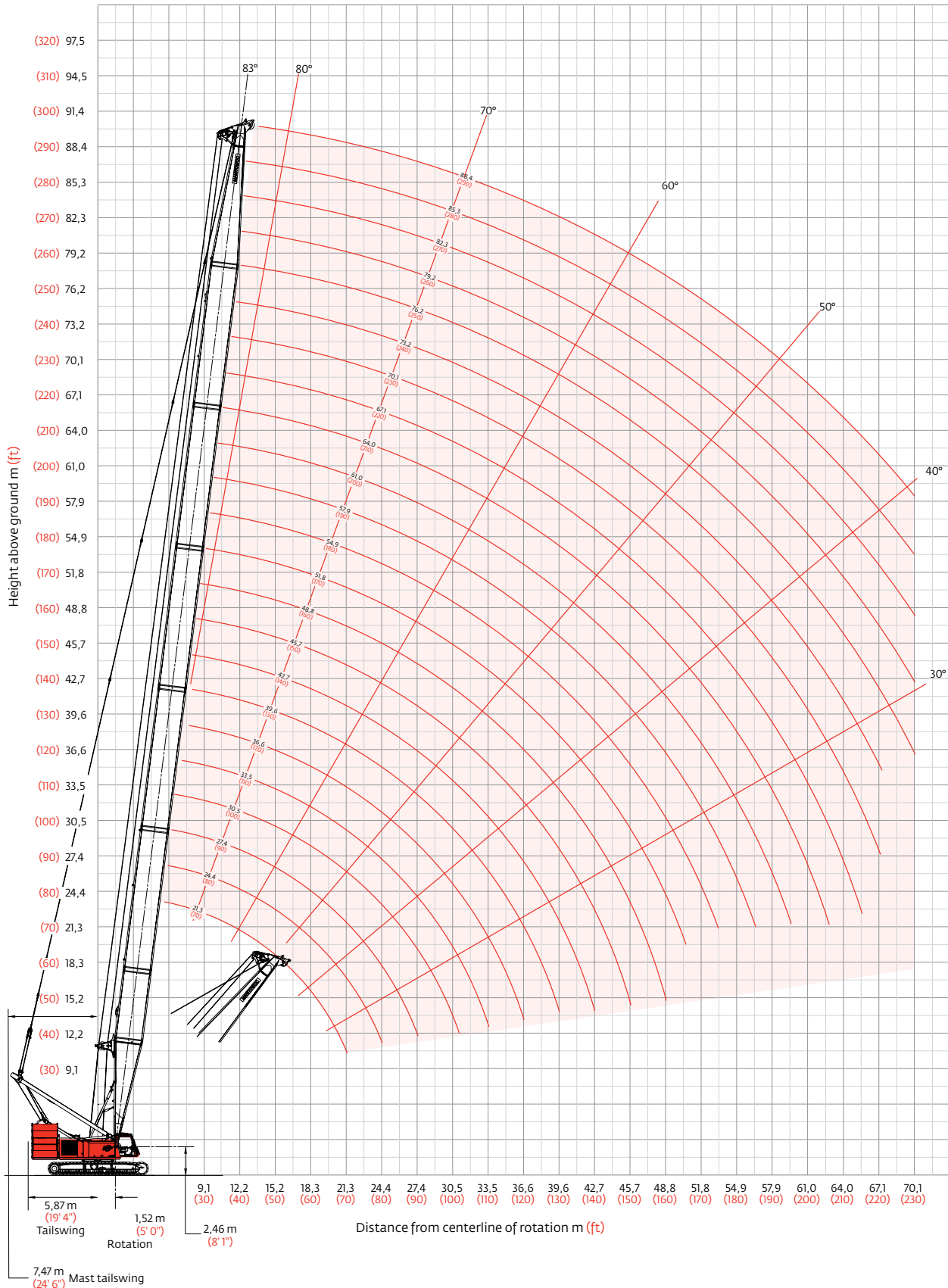



Heavy-lift boom load charts

Liftcrane boom capacities - Series 3 Boom No. 82 or No. 22EL												
Boom m (ft) Radius	99 609 kg (219,600 lb) Upperworks Counterweight 360° Rating 36 288 kg (80,000 lb) Carbody Counterweight kg (lb) x1 000											
	21,3 (70)	27,4 (90)	33,5 (110)	39,6 (130)	45,7 (150)	51,8 (170)	57,9 (190)	64,0 (210)	70,1 (230)	76,2 (250)	82,3 (270)	88,4 (290)
4,6 (15)	250,0* (551.0)*											
5,0 (17)	219,9 (462.5)											
6,0 (20)	183,0 (397.5)	180,7 (396.4)										
8,0 (26)	139,0 (309.3)	138,5 (308.3)	138,1 (307.5)	133,2 (295.0)	120,1 (265.5)							
10,0 (32)	111,5 (252.2)	111,1 (251.2)	110,8 (250.5)	110,5 (249.9)	110,6 (248.9)	100,8 (224.1)	88,6 (196.8)					
11,0 (36)	100,2 (221.8)	100,3 (222.0)	100,4 (222.1)	100,3 (221.9)	99,9 (221.0)	97,6 (215.7)	86,3 (190.5)	76,7 (169.2)	63,1 (139.3)			
12,0 (40)	88,2 (190.3)	88,3 (190.4)	88,3 (190.4)	88,3 (190.4)	88,2 (190.0)	88,3 (189.7)	81,4 (177.0)	74,9 (164.5)	62,8 (138.4)	51,8 (114.1)	— (95.1)	
14,0 (46)	70,9 (156.1)	70,9 (156.2)	70,9 (156.1)	70,9 (156.0)	70,6 (155.5)	70,5 (155.1)	70,3 (154.6)	67,9 (149.6)	62,1 (137.1)	51,2 (113.0)	42,6 (94.1)	35,3 (77.9)
15,0 (50)	64,4 (139.0)	64,4 (139.0)	64,4 (138.9)	64,3 (138.8)	64,1 (138.3)	63,9 (137.9)	63,6 (137.3)	63,6 (136.7)	60,7 (132.5)	50,9 (112.2)	42,3 (93.3)	35,0 (77.2)
18,0 (60)	50,1 (108.2)	50,1 (108.1)	50,0 (108.0)	49,9 (107.8)	49,6 (107.2)	49,5 (106.8)	49,1 (106.1)	48,9 (105.5)	48,6 (104.7)	48,2 (104.7)	41,5 (91.4)	34,3 (75.5)
24,0 (80)		33,6 (72.6)	33,6 (72.5)	33,5 (72.3)	33,2 (71.7)	33,0 (71.2)	32,6 (70.4)	32,3 (69.8)	31,9 (68.9)	31,9 (68.9)	31,5 (68.0)	31,3 (67.2)
30,0 (100)			24,4 (52.7)	24,3 (52.5)	24,1 (51.9)	23,8 (51.4)	23,5 (50.6)	23,1 (49.9)	22,7 (49.0)	22,7 (48.9)	22,3 (48.0)	21,9 (47.2)
34,0 (110)			— (41.6)	20,2 (45.6)	19,9 (45.0)	19,7 (44.4)	19,3 (43.6)	19,0 (42.9)	18,6 (42.0)	18,6 (42.0)	18,1 (41.0)	17,7 (40.2)
36,0 (120)				18,5 (39.8)	18,2 (39.2)	18,0 (38.7)	17,6 (37.9)	17,3 (37.2)	16,9 (36.3)	16,8 (36.2)	16,4 (35.3)	16,0 (34.5)
40,0 (130)				— (30.9)	15,3 (34.5)	15,1 (34.0)	14,8 (33.2)	14,4 (32.4)	14,0 (31.6)	14,0 (31.5)	13,5 (30.5)	13,2 (29.7)
42,0 (140)					13,9 (29.3)	13,9 (29.9)	13,5 (29.1)	13,2 (28.4)	12,8 (27.5)	12,8 (27.4)	12,3 (26.5)	12,0 (25.6)
46,0 (150)					— (22.4)	11,7 (26.4)	11,5 (25.7)	11,1 (24.9)	10,7 (24.0)	10,7 (24.0)	10,2 (23.0)	9,8 (22.1)
50,0 (160)						8,7 (21.4)	9,7 (22.6)	9,4 (21.9)	9,0 (21.0)	8,9 (20.9)	8,5 (20.0)	8,1 (19.1)
52,0 (170)							8,5 (19.1)	8,6 (19.3)	8,2 (18.4)	8,2 (18.3)	7,8 (17.4)	7,4 (16.5)
58,0 (190)								5,8 (13.0)	6,1 (13.6)	6,2 (13.9)	5,8 (12.9)	5,4 (12.1)
64,0 (210)									3,4 (7.6)	4,1 (9.1)	3,9 (8.8)	3,8 (8.5)
70,0 (230)										1,8 (4.1)	1,9 (4.2)	1,8 (4.0)

Fixed Jib No. 134 on Heavy-Lift Boom No. 82 or No. 22EL	
Jib Length m (ft)	Deduct from Capacity when fixed jib is attached kg (lb)
9,1 (30)	1 220 (2,700)
12,2 (40)	1 590 (3,500)
15,2 (50)	1 950 (4,300)
18,3 (60)	2 310 (5,100)
21,3 (70)	2 770 (6,100)
24,4 (80)	3 220 (7,100)

*NOTE: Special equipment required.
Meets ANSI B30.5 Requirements - Capacities do not exceed 75% of static tipping load.
NOTICE: This capacity chart is for reference only and must not be used for lifting purposes.



Long-reach top range diagram

No. 82 Long-reach boom

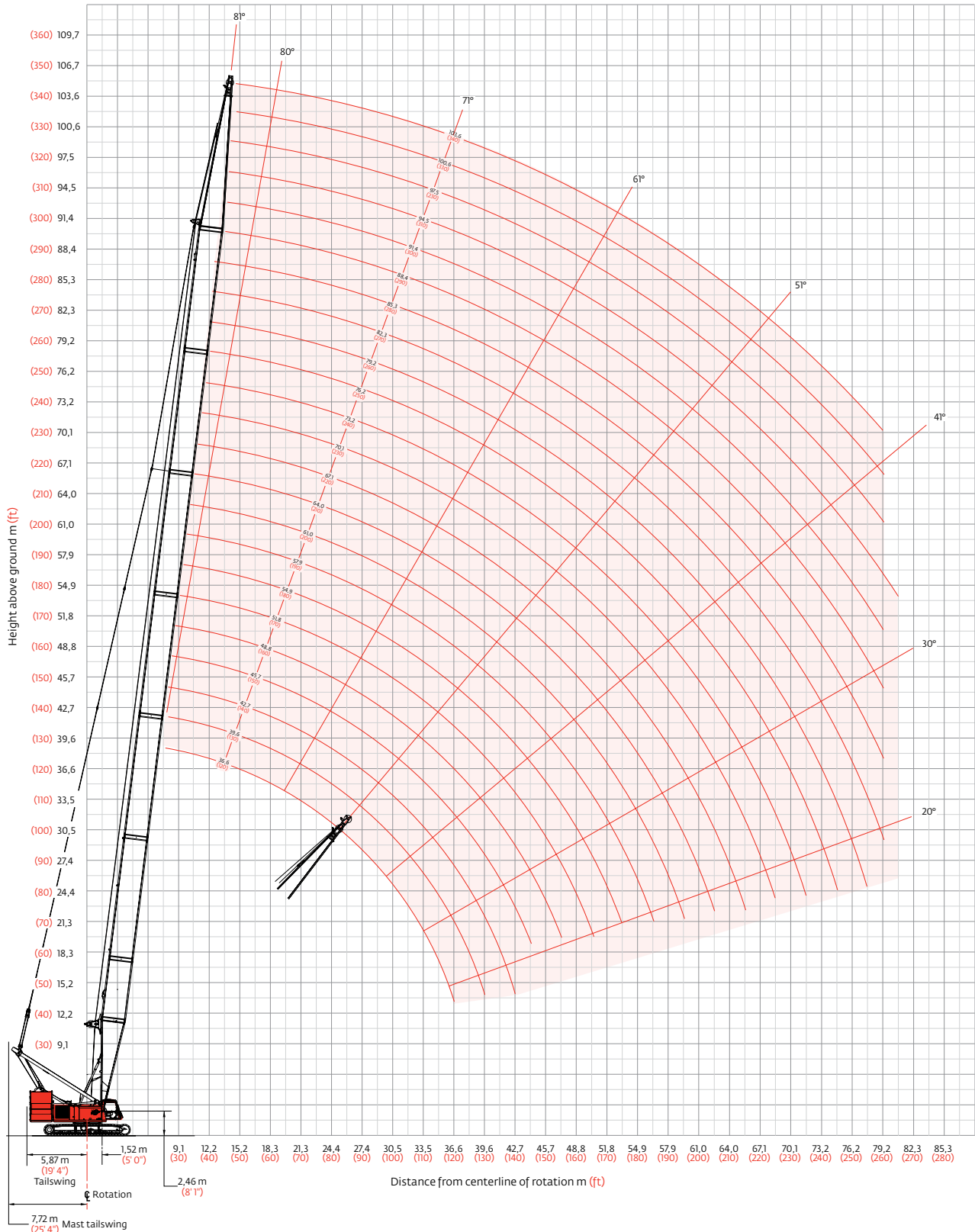



Long-reach top load chart

Liftcrane boom capacities - Series 3 Boom No. 82LR													
Boom m (ft) Radius	99 609 kg (219,600 lb) Upperworks Counterweight 360° Rating 36 288 kg (80,000 lb) Carbody Counterweight kg (lb) x1 000												
	36,6 (120)	42,7 (140)	48,8 (160)	54,9 (180)	61,0 (200)	67,1 (220)	73,2 (240)	79,2 (260)	85,3 (280)	91,4 (300)	97,5 (320)	103,6 (340)	
7,3 (24)	120,4 (265.5)												
9,0 (28)	110,2 (252.4)	118,7 (265.5)											
10,0 (30)	102,0 (240.3)	111,3 (260.7)	106,8 (236.0)										
11,0 (34)	94,9 (219.1)	102,0 (238.9)	101,6 (234.8)	93,1 (206.4)									
12,0 (40)	88,4 (192.0)	90,4 (195.0)	90,3 (194.5)	89,5 (194.1)	79,7 (175.4)	— (152.5)							
14,0 (46)	73,0 (160.8)	73,0 (160.7)	72,8 (160.2)	72,5 (159.7)	72,3 (159.1)	68,3 (150.7)	56,5 (124.6)	47,0 (103.7)					
15,0 (50)	66,5 (143.7)	66,4 (143.5)	66,2 (143.0)	66,0 (142.5)	65,7 (141.9)	65,8 (141.2)	56,1 (123.6)	46,7 (102.8)	— (85.6)				
16,0 (55)	61,0 (126.6)	60,9 (126.3)	60,7 (125.8)	60,4 (125.2)	60,2 (124.6)	59,8 (123.9)	55,7 (122.3)	46,3 (101.7)	38,6 (84.7)				
16,0 (55)	61,0 (126.6)	60,9 (126.3)	60,7 (125.8)	60,4 (125.2)	60,2 (124.6)	59,8 (123.9)	55,7 (122.3)	46,3 (101.7)	38,6 (84.7)	— (71.6)	— (65.3)		
18,0 (60)	52,2 (112.9)	52,1 (112.6)	51,8 (112.0)	51,6 (111.5)	51,3 (110.8)	51,0 (110.1)	51,0 (109.3)	45,7 (100.6)	38,0 (83.7)	32,1 (70.7)	29,3 (64.6)	— (55.7)	
22,0 (70)	40,2 (92.3)	40,0 (92.0)	39,7 (91.3)	39,5 (90.8)	39,1 (90.0)	38,8 (89.4)	38,4 (88.5)	38,1 (87.8)	36,6 (81.8)	31,0 (68.9)	28,2 (63.1)	24,5 (54.3)	
24,0 (80)	35,8 (77.5)	35,7 (77.2)	35,4 (76.6)	35,1 (76.0)	34,8 (75.2)	34,5 (74.5)	34,1 (73.7)	33,8 (72.9)	33,6 (72.0)	30,5 (67.2)	26,5 (57.9)	24,1 (53.0)	
30,0 (100)	26,7 (57.8)	26,6 (57.5)	26,3 (56.9)	26,0 (56.3)	25,7 (55.5)	25,3 (54.7)	24,9 (53.9)	24,6 (53.1)	24,1 (52.1)	23,8 (51.3)	22,7 (49.5)	21,0 (45.8)	
36,0 (120)	19,9 (41.7)	20,8 (44.9)	20,5 (44.3)	20,2 (43.7)	9,9 (42.9)	19,5 (42.1)	19,1 (41.2)	18,7 (40.4)	18,3 (39.5)	17,9 (38.6)	17,7 (38.1)	17,3 (37.2)	
42,0 (140)		15,8 (33.0)	16,4 (35.5)	16,2 (34.9)	15,8 (34.1)	15,5 (33.4)	15,1 (32.5)	14,7 (31.6)	14,2 (30.7)	13,9 (29.8)	13,6 (29.3)	13,2 (28.3)	
48,0 (155)			— (28.9)	13,2 (29.9)	12,8 (29.1)	12,5 (28.4)	12,1 (27.5)	11,7 (26.6)	11,3 (25.7)	10,9 (24.8)	10,6 (24.2)	10,2 (23.3)	
54,0 (175)				— (22.5)	10,5 (23.8)	10,2 (23.1)	9,8 (22.2)	9,4 (21.4)	9,0 (20.4)	8,6 (19.6)	8,3 (19.0)	7,9 (18.0)	
60,0 (195)					— (17.2)	8,3 (18.9)	8,0 (18.1)	7,6 (17.3)	7,2 (16.3)	6,8 (15.4)	6,5 (14.8)	6,1 (13.9)	
64,0 (215)						6,4 (12.6)	6,8 (13.7)	6,6 (13.9)	6,2 (13.0)	5,8 (12.1)	5,5 (11.5)	5,1 (10.6)	
68,0 (225)							5,2 (11.1)	5,4 (11.6)	5,3 (11.4)	4,9 (10.6)	4,6 (10.0)	4,2 (9.1)	
72,0 (240)								4,1 (8.3)	4,1 (8.2)	3,9 (8.0)	3,8 (8.1)	3,4 (7.2)	
76,0 (255)								2,7 (4.8)	2,9 (5.3)	2,8 (5.2)	2,9 (5.5)	2,6 (5.0)	
78,0 (260)									2,3 (4.4)	2,2 (4.4)	2,4 (4.7)	2,1 (4.1)	

Fixed jib No. 134 on No. 82 Long reach top on boom No. 82	
Jib Length m (ft)	Deduct from Capacity when fixed jib is attached kg (lb)
9,1 (30)	1 220 (2,700)
12,2 (40)	1 590 (3,500)
15,2 (50)	1 950 (4,300)
18,3 (60)	2 310 (5,100)
21,3 (70)	2 770 (6,100)
24,4 (80)	3 220 (7,100)

Fixed jib No. 134 on No. 82 Long reach top on boom No. 82	
Jib Length m (ft)	Deduct from Capacity when fixed jib is attached kg (lb)
9,1 (30)	1 330 (2,500)
12,2 (40)	1 410 (3,100)
15,2 (50)	1 680 (3,700)
18,3 (60)	2 000 (4,400)

Meets ANSI B30.5 Requirements - Capacities do not exceed 75% of static tipping load.
 NOTICE: This capacity chart is for reference only and must not be used for lifting purposes.



Open throat top boom range diagram

No. 22E Main boom with open throat top

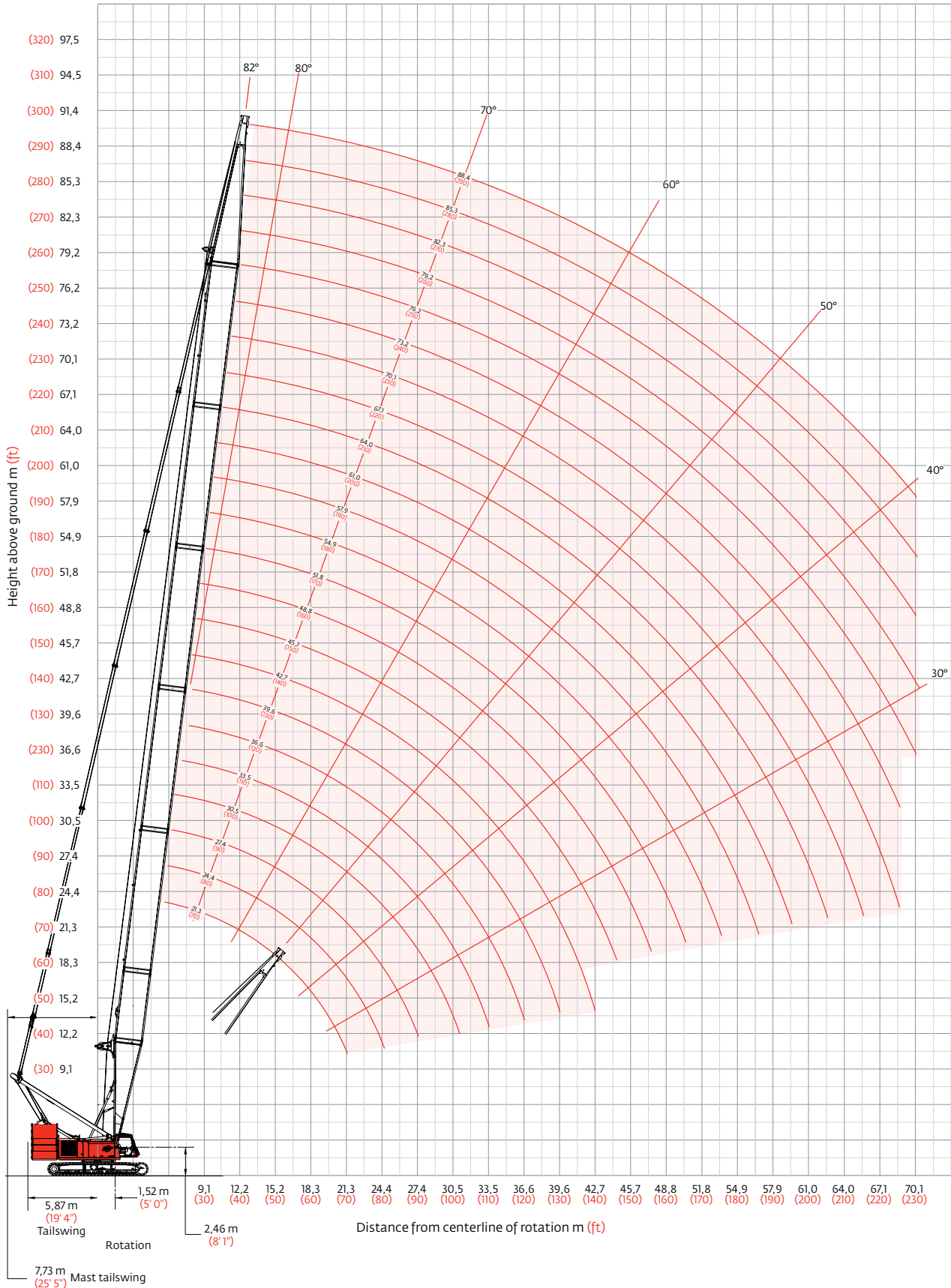



Open throat top load chart

Liftcrane boom capacities - Series 3 Boom No. 22E with open throat top													
Boom m (ft) Radius	99 609 kg (219,600 lb) Upperworks Counterweight 360° Rating 36 288 kg (80,000 lb) Carbody Counterweight kg (lb) x1 000												
	21,3 (70)	27,4 (90)	33,5 (110)	39,6 (130)	45,7 (150)	51,8 (170)	57,9 (190)	64,0 (210)	70,1 (230)	76,2 (250)	82,3 (270)	88,4 (290)	
4,6 (15)	208,6 (460.0)												
5,5 (18)	199,7 (441.2)	171,4 (378.0)											
6,0 (20)	184,1 (400.0)	167,2 (366.9)											
8,0 (26)	140,1 (311.8)	139,6 (310.8)	134,8 (298.4)	121,5 (270.9)	108,8 (240.5)								
10,0 (32)	112,7 (254.7)	112,2 (253.7)	111,8 (252.7)	112,0 (252.0)	101,6 (226.0)	92,0 (204.5)	81,5 (181.0)						
12,0 (40)	88,4 (190.8)	88,4 (190.6)	88,2 (190.3)	88,1 (190.0)	88,0 (189.4)	86,4 (188.8)	77,3 (169.7)	69,5 (152.6)	60,9 (134.2)	— (110.9)			
15,0 (50)	64,9 (140.1)	64,7 (139.7)	64,5 (139.3)	64,4 (138.9)	64,0 (138.2)	63,8 (137.6)	63,4 (136.8)	63,2 (136.1)	57,1 (125.2)	49,5 (109.0)	41,2 (90.8)	34,2 (75.3)	
18,0 (60)	50,7 (109.6)	50,5 (109.2)	50,3 (108.7)	50,1 (108.3)	49,8 (107.5)	49,5 (106.9)	49,1 (106.0)	48,8 (105.3)	48,7 (104.4)	46,8 (102.5)	40,4 (88.9)	33,4 (73.6)	
22,0 (70)	— (75.8)	38,6 (88.8)	38,3 (88.2)	38,2 (87.8)	37,8 (87.0)	37,5 (86.4)	37,1 (85.5)	36,7 (84.7)	36,3 (83.8)	36,0 (83.1)	35,8 (82.2)	32,2 (71.9)	
24,0 (80)		34,3 (74.2)	34,1 (73.6)	33,9 (73.2)	33,5 (72.4)	33,2 (71.7)	32,8 (70.8)	32,4 (70.0)	32,0 (69.1)	31,7 (68.3)	31,2 (67.4)	30,6 (66.5)	
28,0 (90)		— (57.3)	27,5 (62.6)	27,4 (62.2)	27,0 (61.4)	26,7 (60.7)	26,3 (59.8)	25,9 (59.0)	25,5 (58.1)	25,1 (57.3)	24,7 (56.3)	24,3 (55.5)	
30,0 (100)			25,0 (54.0)	24,9 (53.7)	24,5 (52.8)	24,1 (52.1)	23,7 (51.2)	23,4 (50.4)	22,9 (49.5)	22,6 (48.7)	22,2 (47.7)	21,7 (46.8)	
34,0 (110)			— (42.7)	20,7 (46.8)	20,4 (46.0)	20,1 (45.3)	19,7 (44.4)	19,3 (43.6)	18,8 (42.6)	18,5 (41.8)	18,0 (40.8)	17,6 (39.9)	
36,0 (120)				19,0 (41.1)	18,7 (40.3)	18,4 (39.7)	18,0 (38.7)	17,6 (37.9)	17,2 (37.0)	16,8 (36.2)	16,4 (35.2)	16,0 (34.3)	
40,0 (130)				— (32.2)	15,9 (35.6)	15,6 (35.0)	15,1 (34.0)	14,8 (33.2)	14,4 (32.3)	14,0 (31.5)	13,5 (30.5)	13,1 (29.6)	
42,0 (140)					14,5 (30.6)	14,4 (31.0)	14,0 (30.1)	13,6 (29.3)	13,2 (28.3)	12,8 (27.5)	12,3 (26.5)	11,9 (25.6)	
46,0 (150)						12,3 (27.5)	11,9 (26.6)	11,6 (25.9)	11,1 (24.9)	10,7 (24.1)	10,3 (23.1)	9,9 (22.2)	
50,0 (160)							9,3 (22.7)	10,2 (23.7)	9,8 (22.9)	9,4 (21.9)	9,0 (21.1)	8,6 (20.1)	8,2 (19.2)
52,0 (170)								9,0 (20.2)	9,1 (20.3)	8,6 (19.3)	8,3 (18.5)	7,8 (17.5)	7,4 (16.6)
58,0 (190)									6,3 (14.1)	6,5 (14.5)	6,4 (14.2)	5,9 (13.2)	5,5 (12.3)
64,0 (210)										3,9 (8.7)	4,1 (9.2)	4,0 (8.9)	3,9 (8.6)
68,0 (225)											2,2 (4.4)	2,7 (5.6)	2,5 (5.2)
70,0 (230)												2,0 (4.4)	1,8 (4.1)

Fixed jib No. 123 on No. 22C open throat top on boom No. 22E	
Jib Length m (ft)	Deduct from Capacity when fixed jib is attached kg (lb)
9,1 (30)	1 130 (2,500)
12,2 (40)	1 410 (3,100)
15,2 (50)	1 680 (3,700)
18,3 (60)	2 000 (4,400)

Meets ANSI B30.5 Requirements - Capacities do not exceed 75% of static tipping load.
NOTICE: This capacity chart is for reference only and must not be used for lifting purposes.



Light tapered top range diagram

No. 22E Main boom with light tapered top

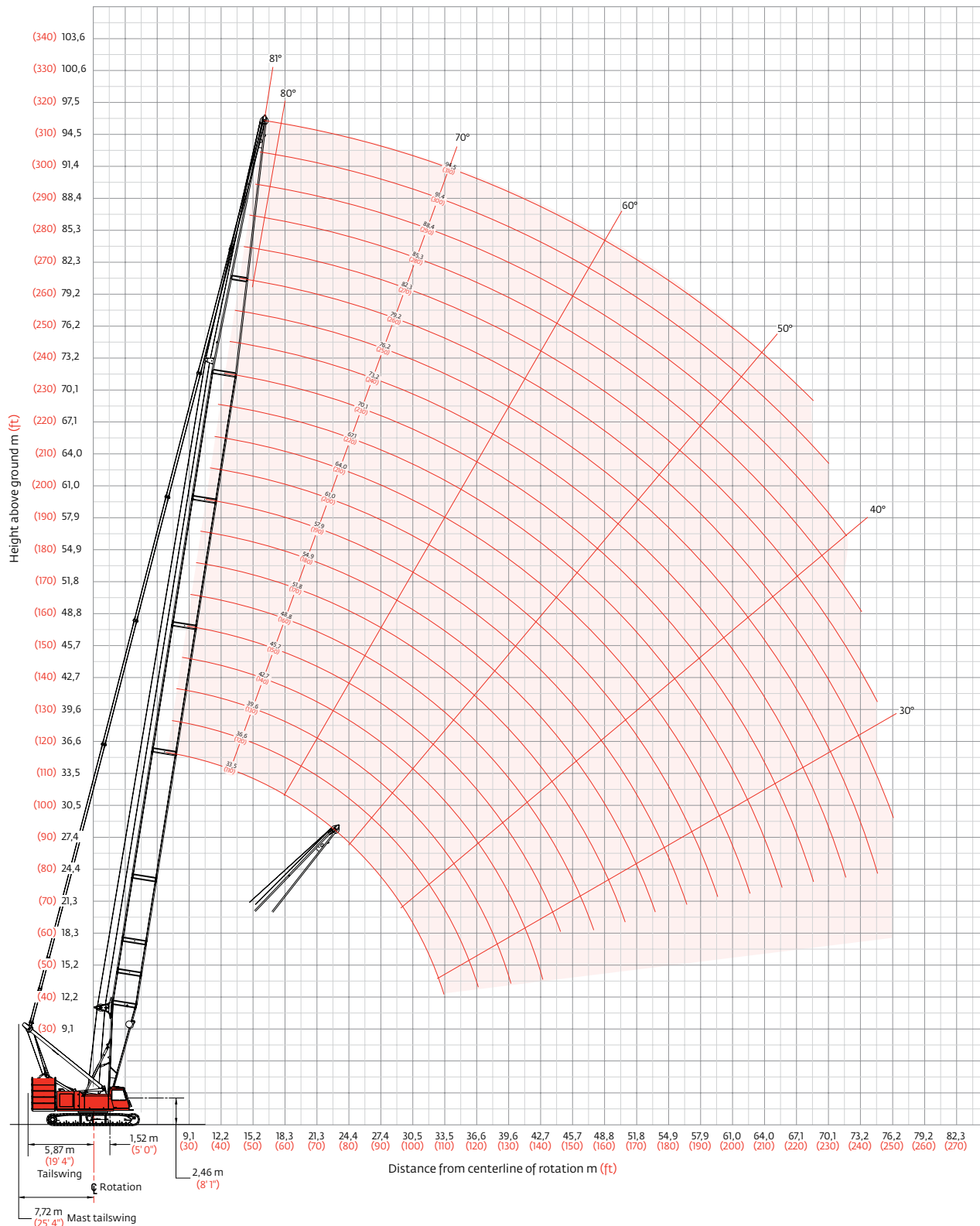



Light tapered top load chart

Liftcrane boom capacities - Series 2 Boom No. 22E with light tapered top													
Boom m (ft) Radius	99 609 kg (219,600 lb) Upperworks Counterweight 360° Rating 36 288 kg (80,000 lb) Carbody Counterweight kg (lb) x1 000												
	33,5 (110)	39,6 (130)	45,7 (150)	51,8 (170)	57,9 (190)	64,0 (210)	70,1 (230)	76,2 (250)	79,2 (260)	82,3 (270)	88,4 (290)	94,5 (310)	
7,3 (24)	120,4 (265.5)												
8,0 (28)	119,9 (256.4)	119,8 (254.9)											
9,0 (30)	110,7 (239.6)	110,0 (238.0)	103,1 (227.3)										
10,0 (34)	97,0 (202.3)	97,0 (202.1)	97,4 (201.6)	90,8 (198.3)									
12,0 (40)	74,2 (160.0)	74,0 (159.6)	73,7 (159.0)	73,4 (158.4)	73,7 (157.8)	69,5 (152.5)							
14,0 (46)	59,9 (131.8)	59,6 (131.3)	59,3 (130.6)	59,0 (130.0)	58,7 (129.2)	58,4 (128.6)	58,0 (127.8)	49,4 (108.9)	45,3 (100.0)				
15,0 (50)	54,5 (117.7)	54,2 (117.1)	53,9 (116.4)	53,6 (115.7)	53,3 (115.0)	53,0 (114.3)	52,6 (113.4)	49,1 (108.1)	45,0 (99.2)	41,3 (90.9)			
18,0 (60)	42,6 (92.2)	42,3 (91.5)	42,0 (90.8)	41,7 (90.1)	41,3 (89.3)	41,0 (88.6)	40,6 (87.7)	40,4 (87.0)	40,5 (86.5)	39,4 (86.1)	33,8 (74.4)	28,3 (62.3)	
22,0 (70)	32,7 (75.3)	32,4 (74.5)	32,0 (73.7)	31,7 (73.0)	31,3 (72.1)	31,0 (71.4)	30,6 (70.5)	30,2 (69.7)	30,0 (69.3)	29,8 (68.9)	29,5 (68.0)	26,1 (58.4)	
24,0 (80)	29,2 (63.1)	28,8 (62.3)	28,4 (61.5)	28,1 (60.8)	27,7 (59.9)	27,4 (59.1)	27,0 (58.2)	26,6 (57.4)	26,4 (57.0)	26,2 (56.5)	25,8 (55.6)	25,0 (54.7)	
28,0 (90)	23,8 (54.0)	23,4 (53.1)	23,0 (52.3)	22,7 (51.6)	22,3 (50.7)	21,9 (49.9)	21,5 (49.0)	21,1 (48.2)	20,9 (47.7)	20,7 (47.3)	20,3 (46.4)	19,9 (45.4)	
32,0 (100)	19,8 (46.8)	19,5 (46.0)	19,0 (45.1)	18,8 (44.5)	18,3 (43.5)	18,0 (42.7)	17,6 (41.8)	17,2 (41.0)	17,0 (40.6)	16,7 (40.1)	16,3 (39.2)	15,9 (38.2)	
36,0 (120)		16,4 (35.5)	16,1 (34.7)	15,8 (34.1)	15,4 (33.1)	15,0 (32.3)	14,5 (31.3)	14,2 (30.6)	14,0 (30.1)	13,7 (29.6)	13,3 (28.7)	12,9 (27.7)	
42,0 (140)			12,7 (27.4)	12,4 (26.8)	12,0 (25.9)	11,6 (25.0)	11,2 (24.1)	10,8 (23.3)	10,6 (22.8)	10,4 (22.3)	10,0 (21.4)	9,5 (20.4)	
48,0 (160)				9,9 (21.4)	9,5 (20.5)	9,2 (19.7)	8,7 (18.8)	8,4 (18.0)	8,2 (17.5)	7,9 (17.0)	7,5 (16.1)	7,0 (15.0)	
52,0 (180)					8,2 (16.4)	7,8 (15.6)	7,4 (14.7)	7,1 (13.9)	6,8 (13.4)	6,6 (12.9)	6,2 (12.0)	5,7 (10.9)	
56,0 (200)					7,1 —	6,7 (12.3)	6,3 (11.4)	6,0 (10.6)	5,7 (10.2)	5,5 (9.6)	5,1 (8.7)	4,6 (7.7)	
60,0 (210)							5,8 —	5,3 (10.0)	5,0 (9.3)	4,8 (8.8)	4,5 (8.2)	4,1 (7.4)	3,6 (6.3)
64,0 (220)								4,5 (8.7)	4,2 (8.0)	3,9 (7.5)	3,7 (7.0)	3,3 (6.1)	2,8 (5.1)
70,0 (230)									3,1 (6.8)	2,9 (6.4)	2,6 (5.8)	2,2 (5.0)	
74,0 (240)										2,5 (5.8)	2,2 (5.3)		
76,0 (250)											1,9 (4.3)		

Fixed Jib No. 123 on light tapered top boom No. 22E	
Jib Length m (ft)	Deduct from Capacity when fixed jib is attached kg (lb)
9,1 (30)	1 130 (2,500)
12,2 (40)	1 410 (3,100)
15,2 (50)	1 680 (3,700)
18,3 (60)	2 000 (4,400)

Meets ANSI B30.5 Requirements - Capacities do not exceed 75% of static tipping load.
 NOTICE: This capacity chart is for reference only and must not be used for lifting purposes.



Fixed jib range diagram

No. 134 Fixed jib on No. 82 or No. 22EL main boom

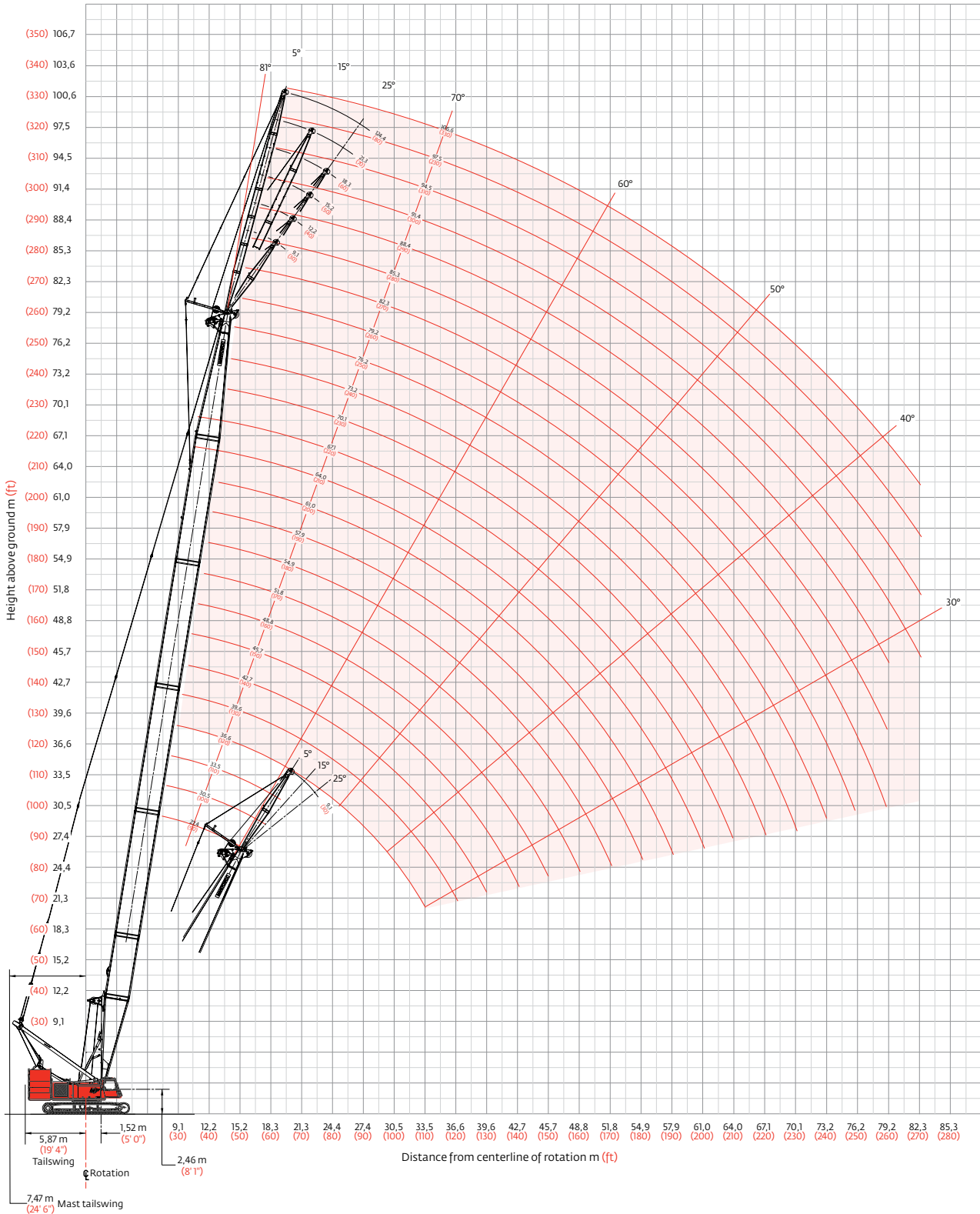



Fixed jib load charts

Liftcrane boom capacities
Fixed jib No. 134 with 3 810 mm (12' 6") strut on
boom No. 82 or No. 22EL

		99 609 kg (219,600 lb) Upperworks Counterweight 36 288 kg (80,000 lb) Carbody Counterweight 360° Rating kg (lb) x1 000									
		5° Offset					25° Offset				
Boom m (ft)	Radius	27,4 (90)	39,6 (130)	54,9 (180)	70,1 (230)	82,3 (270)	27,4 (90)	39,6 (130)	54,9 (180)	70,1 (230)	82,3 (270)
Jib Length 9,1 m (30 ft)	9,1 (30)	26,7 (59.0)									
	12,0 (40)	26,7 (59.0)	26,7 (59.0)				— (48.9)				
	16,0 (50)	26,7 (59.0)	26,7 (59.0)	26,7 (59.0)	26,7 (59.0)		19,3 (43.8)	21,2 (47.8)			
	22,0 (70)	25,3 (56.2)	26,6 (59.0)	26,7 (59.0)	26,7 (59.0)	25,3 (56.0)	16,3 (36.7)	18,3 (41.1)	20,1 (45.0)	21,4 (47.9)	22,3 (49.7)
	28,0 (90)	23,8 (53.3)	25,4 (56.3)	26,3 (59.0)	26,0 (58.7)	24,4 (54.3)	14,4 (32.2)	16,3 (36.3)	18,1 (40.4)	19,5 (43.5)	20,4 (45.5)
	36,0 (120)		19,3 (41.7)	18,4 (39.6)	17,3 (37.3)	16,7 (36.0)		14,4 (31.6)	16,1 (35.4)	17,5 (38.5)	17,6 (37.7)
	48,0 (150)		— (28.5)	11,3 (27.3)	10,2 (25.0)	9,6 (23.7)			11,6 (28.1)	10,7 (26.0)	10,2 (24.9)
	56,0 (180)			8,2 (19.3)	7,3 (17.0)	6,7 (15.7)				7,6 (17.7)	7,1 (16.6)
	64,0 (210)				4,9 (10.9)	4,5 (10.1)					4,8 (10.7)
	72,0 (240)					2,2 (4.3)					
	80,0 (270)										

		5° Offset					25° Offset				
Boom m (ft)	Radius	27,4 (90)	39,6 (130)	54,9 (180)	70,1 (230)	79,2 (260)	27,4 (90)	39,6 (130)	54,9 (180)	70,1 (230)	79,2 (260)
Jib Length 15,2 m (50 ft)	9,1 (30)										
	12,0 (40)	18,9 (41.6)	— (43.3)								
	16,0 (50)	17,5 (39.3)	18,5 (41.4)	19,3 (43.1)			14,5 (33.0)				
	22,0 (70)	15,9 (35.6)	17,0 (38.0)	18,0 (40.2)	18,7 (41.7)	19,1 (42.5)	11,9 (26.8)	13,1 (29.5)	14,2 (31.9)		
	28,0 (90)	14,7 (32.8)	15,9 (35.3)	16,9 (37.7)	17,8 (39.5)	18,1 (40.3)	10,2 (22.8)	11,4 (25.6)	12,6 (28.2)	13,5 (30.2)	13,9 (31.1)
	36,0 (120)	12,3 (26.8)	14,6 (32.1)	15,7 (34.6)	16,6 (36.6)	17,1 (37.5)		9,9 (21.6)	11,0 (24.2)	12,0 (26.3)	12,4 (27.3)
	48,0 (150)	4,5 (10.0)	11,7 (27.1)	11,8 (28.3)	10,7 (25.9)	10,3 (25.1)			9,4 (21.4)	10,3 (23.4)	10,8 (24.5)
	56,0 (180)		4,5 (10.0)	8,8 (20.3)	7,7 (17.9)	7,3 (17.1)			8,7 (19.5)	8,2 (19.1)	8,0 (18.5)
	64,0 (210)			5,8 (13.0)	5,5 (12.2)	5,1 (11.4)				5,9 (13.1)	5,6 (12.5)
	72,0 (240)				3,1 (6.2)	3,2 (6.5)					3,8 (7.8)
	80,0 (270)										

Meets ANSI B30.5 Requirements - Capacities do not exceed 75% of static tipping load.
 NOTICE: This capacity chart is for reference only and must not be used for lifting purposes.



Fixed jib load charts

Liftcrane boom capacities

Fixed jib No. 134 with 3 810 mm (12' 6") strut on boom No. 82 or No. 22EL

		99 609 kg (219,600 lb) Upperworks Counterweight 36 288 kg (80,000 lb) Carbody Counterweight 360° Rating kg (lb) x1 000									
		5° Offset					25° Offset				
Boom m (ft) Radius		27,4 (90)	39,6 (130)	54,9 (180)	70,1 (230)	79,2 (260)	27,4 (90)	39,6 (130)	54,9 (180)	70,1 (230)	79,2 (260)
Jib Length 18,3 m (60 ft)	9,1 (30)										
	12,0 (40)	15,9 (35.0)	— (36.3)								
	16,0 (50)	14,8 (33.2)	15,6 (34.8)	16,2 (36.1)							
	22,0 (70)	13,4 (30.1)	14,4 (32.1)	15,1 (33.7)	15,7 (34.9)	16,0 (35.5)	10,8 (24.4)	11,3 (25.1)	11,5 (25.7)		
	28,0 (90)	12,2 (27.3)	13,3 (29.6)	14,2 (31.7)	14,9 (33.1)	15,2 (33.8)	9,1 (20.4)	10,2 (22.8)	11,1 (24.6)	11,3 (25.1)	11,4 (25.4)
	36,0 (120)	10,8 (23.4)	12,1 (26.5)	13,1 (28.8)	13,9 (30.6)	14,3 (31.5)	7,6 (16.6)	8,6 (18.9)	9,6 (21.1)	10,4 (22.9)	10,9 (23.9)
	48,0 (150)		10,0 (23.3)	11,7 (26.5)	10,8 (26.2)	10,4 (25.4)		7,2 (16.3)	8,1 (18.4)	8,9 (20.2)	9,3 (21.2)
	56,0 (180)		8,5 (19.3)	9,0 (20.7)	7,8 (18.2)	7,5 (17.3)			7,4 (16.5)	8,1 (18.2)	8,3 (19.1)
	64,0 (210)			6,4 (14.3)	5,6 (12.5)	5,3 (11.7)				6,2 (13.7)	5,9 (13.1)
	72,0 (240)				3,5 (7.1)	3,5 (7.2)					4,0 (8.5)
	80,0 (270)										

		5° Offset					25° Offset				
Boom m (ft) Radius		27,4 (90)	39,6 (130)	54,9 (180)	70,1 (230)	76,2 (250)	27,4 (90)	39,6 (130)	54,9 (180)	70,1 (230)	76,2 (250)
Jib Length 24,4 m (80 ft)	9,1 (30)										
	12,0 (40)	— (20.6)									
	16,0 (50)	9,1 (20.3)	9,3 (20.6)	9,4 (20.8)							
	22,0 (70)	8,9 (19.7)	9,0 (20.0)	9,1 (20.3)	9,3 (20.6)	9,3 (20.6)	7,7 (17.3)	7,9 (17.7)			
	28,0 (90)	8,1 (18.1)	8,8 (19.6)	9,0 (19.9)	9,1 (20.2)	9,1 (20.3)	7,1 (15.8)	7,4 (16.5)	7,7 (17.1)	7,9 (17.6)	7,9 (17.7)
	36,0 (120)	7,1 (15.7)	7,9 (17.4)	8,6 (19.0)	8,9 (19.7)	8,9 (19.8)	5,9 (12.9)	6,7 (14.6)	7,2 (15.8)	7,4 (16.4)	7,5 (16.5)
	48,0 (150)	6,0 (13.7)	6,8 (15.5)	7,6 (17.2)	8,2 (18.5)	8,4 (19.0)	— (10.7)	5,3 (12.3)	6,0 (14.0)	6,7 (15.3)	6,9 (15.5)
	56,0 (180)		6,2 (13.9)	7,0 (15.6)	7,6 (17.1)	7,8 (17.6)		— (10.7)	5,4 (12.2)	6,0 (13.6)	6,2 (14.1)
	64,0 (210)			6,4 (14.3)	5,8 (13.0)	5,7 (12.6)			4,9 (11.0)	5,5 (12.2)	5,7 (12.7)
	72,0 (240)			4,5 (9.3)	4,1 (8.6)	4,0 (8.4)				4,7 (10.0)	4,6 (9.8)
	80,0 (270)				2,0 (—)	2,1 (—)					3,0 (5.4)

Meets ANSI B30.5 Requirements - Capacities do not exceed 75% of static tipping load.

NOTICE: This capacity chart is for reference only and must not be used for lifting purposes.



Fixed jib range diagram

No. 123 Fixed jib on No. 82LR boom

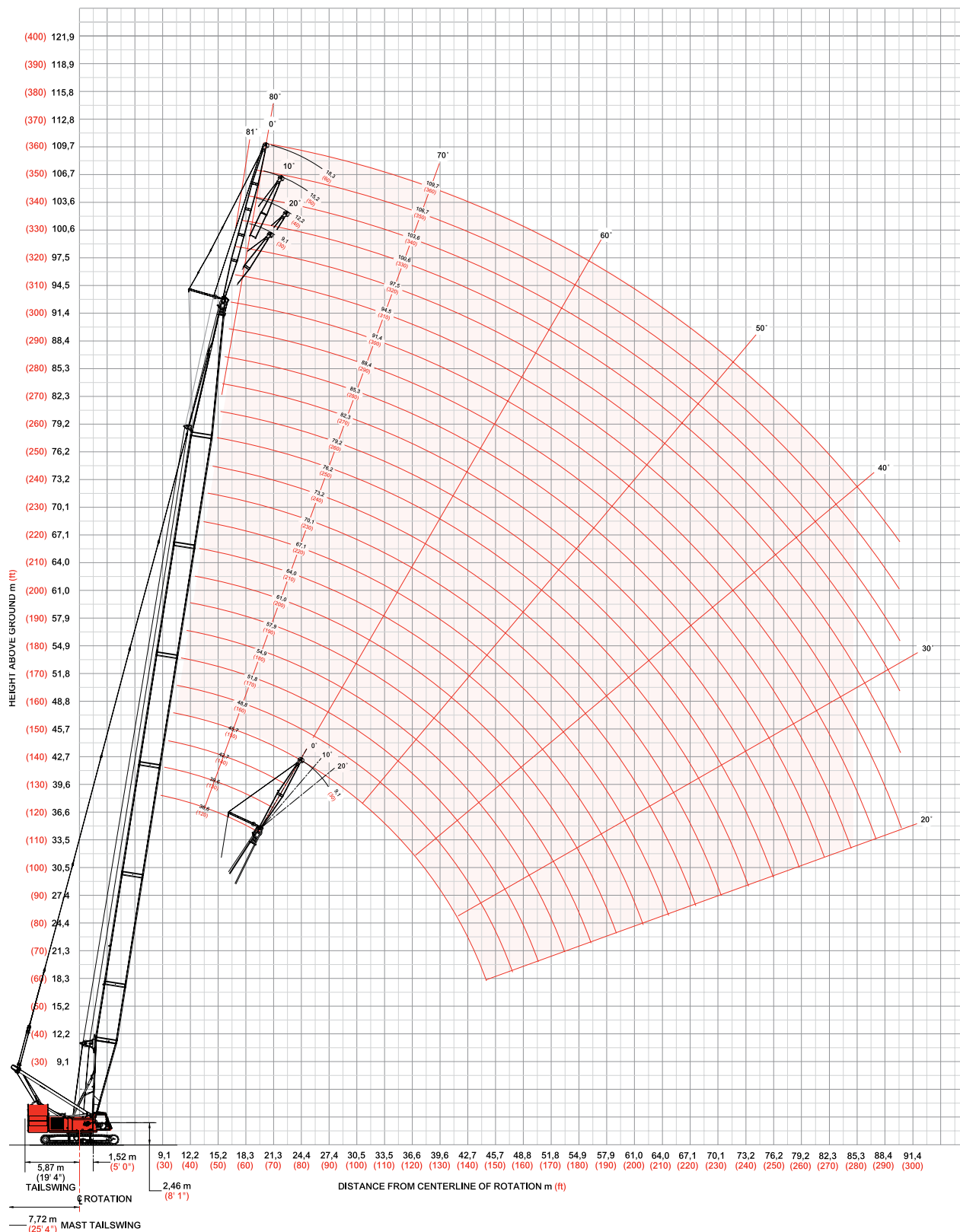



Fixed jib load charts

Liftcrane boom capacities
Jib No. 123 with 3 810 mm (26' 6") strut on boom No. 82LR

99 609 kg (219,600 lb) Upperworks Counterweight 36 288 kg (80,000 lb) Carbody Counterweight
 360° Rating kg (lb) x 1 000

Boom m (ft) Radius	0° Offset					20° Offset					
	36,6 (120)	51,8 (170)	67,1 (220)	82,3 (270)	91,4 (300)	36,6 (120)	51,8 (170)	67,1 (220)	82,3 (270)	91,4 (300)	
Jib Length 9,1 m (30 ft)	10,7 (35)	18,1 (40.0)									
	12,0 (40)	18,1 (40.0)	—								
	16,0 (60)	18,1 (40.0)	18,1 (40.0)	18,1 (40.0)	— (40.0)	— (40.0)					
	22,0 (80)	18,1 (40.0)	18,1 (40.0)	18,1 (40.0)	18,1 (40.0)	18,1 (40.0)	18,1 (40.0)	18,1 (40.0)	18,1 (40.0)	16,9 (37.1)	
	28,0 (100)	18,1 (40.0)	18,1 (40.0)	18,1 (40.0)	18,1 (40.0)	18,1 (40.0)	16,7 (35.1)	18,1 (40.0)	18,1 (40.0)	18,1 (40.0)	16,6 (36.3)
	36,0 (120)	18,1 (40.0)	18,1 (40.0)	18,1 (40.0)	18,1 (40.0)	17,8 (38.8)	14,4 (31.7)	16,7 (36.5)	18,1 (40.0)	18,1 (40.0)	16,1 (35.4)
	48,0 (150)		13,5 (32.2)	12,6 (30.2)	11,6 (28.0)	11,0 (26.5)		13,7 (32.3)	12,9 (30.9)	12,0 (28.9)	11,4 (27.6)
	56,0 (180)		10,6 (24.2)	9,7 (22.2)	8,7 (20.0)	8,0 (18.6)			9,9 (22.7)	9,0 (20.7)	8,4 (19.4)
	68,0 (210)			6,4 (16.7)	5,6 (14.4)	5,0 (13.0)				5,8 (14.9)	5,2 (13.6)
	76,0 (240)			—	3,8 (10.3)	3,4 (8.8)				—	3,7 (9.3)
	80,0 (270)				2,8 (5.0)	2,4 (4.3)					2,7 (—)

Boom m (ft) Radius	0° Offset					20° Offset					
	36,6 (120)	51,8 (170)	67,1 (220)	82,3 (270)	91,4 (300)	36,6 (120)	51,8 (170)	67,1 (220)	82,3 (270)	91,4 (300)	
Jib Length 12,2 m (40 ft)	10,7 (35)	13,6 (30.0)									
	16,0 (50)	13,6 (30.0)	13,6 (30.0)	13,6 (30.0)		13,6 (30.0)					
	22,0 (70)	13,6 (30.0)	13,6 (30.0)	13,6 (30.0)	13,6 (30.0)	13,6 (30.0)	13,6 (30.0)	13,6 (30.0)	13,6 (30.0)		
	28,0 (100)	13,6 (30.0)	13,6 (30.0)	13,6 (30.0)	13,6 (30.0)	13,6 (30.0)	12,6 (26.4)	13,6 (30.0)	13,6 (30.0)	13,6 (30.0)	13,6 (30.0)
	36,0 (130)	13,6 (29.5)	13,6 (30.0)	13,6 (30.0)	13,6 (30.0)	13,6 (30.0)	10,8 (22.6)	12,4 (25.9)	13,6 (28.7)	13,6 (30.0)	13,6 (30.0)
	40,0 (160)	13,2 (—)	13,6 (29.5)	13,6 (27.4)	13,6 (25.2)	13,6 (23.8)	10,2 (—)	11,6 (23.0)	12,9 (25.6)	13,6 (26.3)	13,6 (25.1)
	48,0 (190)	13,2 (—)	13,4 (22.4)	12,7 (20.4)	11,7 (18.2)	11,1 (16.7)		10,5	11,7 (21.0)	12,2 (19.0)	11,7 (17.7)
	56,0 (220)		10,7 (—)	9,8 (15.4)	8,8 (13.1)	8,1 (11.7)			10,1 (—)	9,2 (13.7)	8,6 (12.4)
	68,0 (240)		10,7 (—)	6,7 (11.4)	5,7 (10.5)	5,1 (9.0)				6,0 (11.0)	5,4 (9.7)
	76,0 (260)			4,2 (—)	4,1 (7.4)	3,6 (6.4)				4,4 (—)	3,8 (7.3)
	84,0 (280)				2,1 (4.1)						

Meets ANSI B30.5 Requirements - Capacities do not exceed 75% of static tipping load.
 NOTICE: This capacity chart is for reference only and must not be used for lifting purposes.



Fixed jib load charts

Liftcrane Boom Capacities

Jib No. 123 with 3 810 mm (12' 6") strut on Boom No. 82LR

		99 609 kg (219,600 lb) Upperworks Counterweight 36 288 kg (80,000 lb) Carbody Counterweight					360° Rating kg (lb) x 1 000				
		0° Offset					20° Offset				
Boom m (ft) Radius		36,6 (120)	51,8 (170)	67,1 (220)	82,3 (270)	91,4 (300)	36,6 (120)	51,8 (170)	67,1 (220)	82,3 (270)	91,4 (300)
Jib Length 15,2 m (50 ft)	12,2 (40)	9,0 (20.0)									
	18,0 (50)	9,0 (20.0)	9,0 (20.0)	9,0			9,0				
	24,0 (70)	9,0 (20.0)	9,0 (20.0)	9,0 (20.0)	9,0 (20.0)	9,0 (20.0)	9,0 (20.0)	9,0 (20.0)	9,0 (20.0)		
	32,0 (100)	9,0 (20.0)	9,0 (20.0)	9,0 (20.0)	9,0 (20.0)	9,0 (20.0)	9,0 (20.0)	9,0 (20.0)	9,0 (20.0)	9,0 (20.0)	9,0 (20.0)
	36,0 (130)	9,0 (20.0)	9,0 (20.0)	9,0 (20.0)	9,0 (20.0)	9,0 (20.0)	8,9 (18.7)	9,0 (20.0)	9,0 (20.0)	9,0 (20.0)	9,0 (20.0)
	44,0 (160)	9,0 (20.0)	9,0 (20.0)	9,0 (20.0)	9,0 (20.0)	9,0 (20.0)	7,9	9,0 (18.9)	9,0 (20.0)	9,0 (20.0)	9,0 (20.0)
	52,0 (190)		9,0 (20.0)	9,0 (20.0)	9,0 (18.4)	9,0 (17.0)		8,2	9,0 (19.0)	9,0 (19.5)	9,0 (18.2)
	60,0 (220)		9,0	8,8 (15.6)	7,7 (13.4)	7,1 (11.9)			8,4 (16.1)	8,2 (14.2)	7,6 (12.9)
	68,0 (240)			6,8 (12.5)	5,8 (10.7)	5,1 (9.3)			7,1	6,2 (11.4)	5,1 (10.1)
	80,0 (270)			— (10.2)	3,4 (6.5)	3,0 (5.5)				3,9	3,3 (6.6)
	84,0 (280)				2,5 (4.9)	2,0 (4.0)					2,5 (5.0)

		0° Offset					20° Offset				
Boom m (ft) Radius		36,6 (120)	51,8 (170)	67,1 (220)	82,3 (270)	91,4 (300)	36,6 (120)	51,8 (170)	67,1 (220)	82,3 (270)	91,4 (300)
Jib Length 18,3 m (60 ft)	12,2 (40)	4,5 (10.0)									
	18,0 (50)	4,5 (10.0)	4,5 (10.0)	4,5							
	24,0 (70)	4,5 (10.0)	4,5 (10.0)	4,5 (10.0)	4,5 (10.0)	4,5 (10.0)	4,5 (10.0)	4,5 (10.0)	4,5		
	32,0 (100)	4,5 (10.0)	4,5 (10.0)	4,5 (10.0)	4,5 (10.0)	4,5 (10.0)	4,5 (10.0)	4,5 (10.0)	4,5 (10.0)	4,5 (10.0)	4,5 (10.0)
	36,0 (130)	4,5 (10.0)	4,5 (10.0)	4,5 (10.0)	4,5 (10.0)	4,5 (10.0)	4,5 (10.0)	4,5 (10.0)	4,5 (10.0)	4,5 (10.0)	4,5 (10.0)
	44,0 (160)	4,5 (10.0)	4,5 (10.0)	4,5 (10.0)	4,5 (10.0)	4,5 (10.0)	4,5	4,5 (10.0)	4,5 (10.0)	4,5 (10.0)	4,5 (10.0)
	52,0 (190)	4,5	4,5 (10.0)	4,5 (10.0)	4,5 (10.0)	4,5 (10.0)		4,5 (10.0)	4,5 (10.0)	4,5 (10.0)	4,5 (10.0)
	60,0 (220)		4,5 (10.0)	4,5 (10.0)	4,5 (10.0)	4,5 (10.0)			4,5 (10.0)	4,5 (10.0)	4,5 (10.0)
	68,0 (240)		4,5	4,5 (10.0)	4,5 (10.0)	4,5 (9.4)			4,5	4,5 (10.0)	4,5 (10.0)
	80,0 (260)			4,0 (9.3)	3,7 (8.6)	3,1 (7.1)				4,0 (9.3)	3,5 (8.0)
	88,0 (280)				1,8 (5.4)	— (4.4)					1,9 (5.7)
— (290)				— (4.0)						— (4.2)	

Meets ANSI B30.5 Requirements - Capacities do not exceed 75% of static tipping load.

NOTICE: This capacity chart is for reference only and must not be used for lifting purposes.



Fixed jib range diagram

No. 134 Fixed Jib on No. 82LR Boom

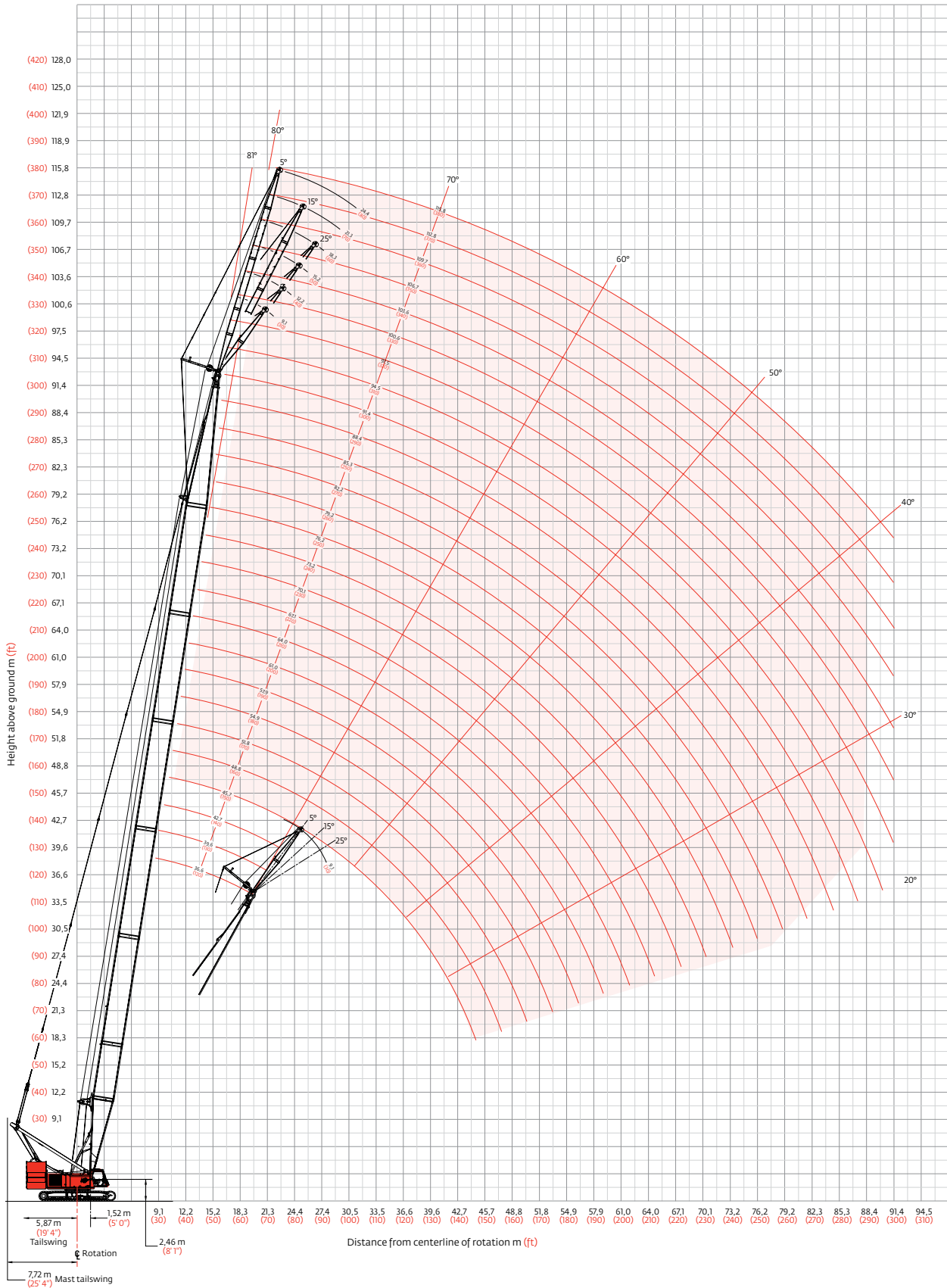



Fixed jib load charts

Liftcrane Boom Capacities Fixed Jib No. 134 with 3 810 mm(12' 6") strut on Boom No. 82LR

		99 609 kg (219,600 lb) Upperworks Counterweight 36 288 kg (80,000 lb) Carbody Counterweight 360° Rating kg (lb) x 1 000									
		5° Offset					25° Offset				
Boom m (ft)	Radius	36,6 (120)	51,8 (170)	67,1 (220)	82,3 (270)	91,4 (300)	36,6 (120)	51,8 (170)	67,1 (220)	82,3 (270)	91,4 (300)
Jib Length 9,1m (30 ft)	10,7 (35)	26,7 (59.0)									
	14,0 (40)	26,7 (59.0)	26,7 (59.0)				20,4 —				
	20,0 (50)	26,1 (59.0)	26,7 (59.0)	26,7 (59.0)	26,2 —	20,3 —	17,6 (43.6)	19,2 (46.6)	20,3 —		
	26,0 (70)	24,6 (56.8)	26,0 (59.0)	26,7 (59.0)	25,5 (57.6)	19,6 (44.5)	15,5 (37.7)	17,2 (41.3)	18,5 (43.8)	19,3 (42.8)	15,6 —
	32,0 (100)	22,2 (51.4)	24,1 (55.5)	23,2 (55.0)	22,3 (52.9)	18,9 (42.1)	14,1 (31.9)	15,7 (35.5)	17,0 (38.4)	18,0 (40.6)	15,4 (34.2)
	40,0 (130)	18,1 (40.3)	17,6 (39.5)	16,7 (37.5)	15,7 (35.3)	15,1 (33.9)		14,2 (31.6)	15,5 (34.4)	16,3 (36.5)	15,0 (33.2)
	48,0 (160)		13,4 (28.9)	12,5 (26.9)	11,5 (24.7)	10,9 (23.3)			12,8 (27.6)	11,9 (25.6)	11,3 (24.3)
	56,0 (190)		— (20.9)	9,5 (19.9)	8,5 (17.6)	7,9 (16.2)			9,7 (20.3)	8,8 (18.3)	8,2 (17.0)
	68,0 (220)			6,1 (14.4)	5,5 (12.6)	4,8 (11.1)				5,6 (13.0)	5,0 (11.7)
	76,0 (250)			— (10.2)	3,6 (7.8)	3,1 (6.9)					3,5 (7.7)
80,0 (270)				2,5 (4.4)	2,1 —						

		5° Offset					25° Offset				
Boom m (ft)	Radius	36,6 (120)	51,8 (170)	67,1 (220)	82,3 (270)	91,4 (300)	36,6 (120)	51,8 (170)	67,1 (220)	82,3 (270)	91,4 (300)
Jib Length 15,2 m (50 ft)	12,2 (40)	18,9 (41.7)									
	16,0 (50)	17,8 (39.7)	18,6 (41.4)								
	20,0 (60)	16,8 (38.0)	17,7 (39.9)	18,4 (41.3)	18,9 —		12,1 (26.7)	13,2 —			
	26,0 (90)	15,6 (33.9)	16,6 (36.2)	17,4 (37.9)	17,9 (39.2)	16,6 (36.5)	11,0 (23.6)	11,9 (25.6)	12,5 (27.2)	11,7 (25.8)	10,2 (22.5)
	32,0 (120)	14,6 (30.9)	15,7 (33.3)	16,5 (35.2)	17,1 (36.7)	16,1 (34.8)	9,8 (20.4)	10,8 (22.5)	11,5 (24.2)	11,7 (25.5)	10,2 (22.5)
	40,0 (150)	13,1 (25.4)	14,6 (31.0)	15,5 (30.5)	16,1 (28.4)	15,3 (27.0)	8,8 —	9,7 (20.3)	10,5 (21.9)	11,1 (23.3)	10,2 (22.5)
	48,0 (180)	10,9 —	13,7 (24.5)	12,8 (22.5)	11,8 (20.3)	11,1 (18.9)		9,0 —	9,7 (20.2)	10,3 (21.5)	10,2 (20.4)
	56,0 (210)		10,7 (17.6)	9,8 (16.8)	8,8 (14.6)	8,2 (13.2)			9,0 (17.5)	9,4 (15.6)	8,8 (14.4)
	68,0 (240)			6,7 (11.9)	5,7 (10.4)	5,0 (9.0)				6,1 (11.1)	5,5 (9.9)
	76,0 (260)			4,5 —	4,2 (7.5)	3,5 (6.5)					3,9 (7.4)
84,0 (280)				2,2 (4.3)							

Meets ANSI B30.5 Requirements - Capacities do not exceed 75% of static tipping load.
NOTICE: This capacity chart is for reference only and must not be used for lifting purposes.



Fixed jib load charts

Liftcrane Boom Capacities Fixed Jib No. 134 with 3 810 mm(12' 6") strut on Boom No. 82LR

		99 609 kg (219,600 lb) Upperworks Counterweight 36 288 kg (80,000 lb) Carbody Counterweight 360° Rating kg (lb) x 1 000									
		5° Offset					25° Offset				
Boom m (ft)	Radius	36,6 (120)	51,8 (170)	67,1 (220)	82,3 (270)	91,5 (300)	36,6 (120)	51,8 (170)	67,1 (220)	82,3 (270)	91,5 (300)
Jib Length 18,3 m (60 ft)	12,2 (40)	14,4 (31.9)									
	16,0 (50)	13,6 (30.5)	14,2 (31.7)								
	20,0 (60)	12,9 (29.2)	13,5 (30.5)	14,0 (31.5)	14,4 —		9,0 —				
	26,0 (90)	11,9 (25.9)	12,7 (27.6)	13,2 (28.9)	13,7 (29.9)	13,9 (30.4)	9,0 (20.0)	10,1 (22.3)	10,3 (22.8)	— (21.1)	— (18.8)
	32,0 (120)	11,0 (23.2)	11,9 (25.2)	12,6 (26.7)	13,0 (27.9)	13,3 (28.5)	8,7 (17.6)	9,6 (19.7)	10,3 (21.4)	9,5 (21.1)	8,5 (18.8)
	40,0 (150)	10,1 (21.2)	11,0 (23.2)	11,7 (24.8)	12,3 (26.1)	12,6 (26.8)	7,5 (15.3)	8,4 (17.3)	9,2 (18.9)	9,5 (20.3)	8,5 (18.8)
	48,0 (180)	9,3 —	10,3 (21.5)	11,0 (22.7)	11,6 (20.5)	11,2 (19.1)		7,5 (15.6)	8,3 (17.1)	9,0 (18.5)	8,5 (18.8)
	56,0 (210)		9,6 (18.9)	9,9 (17.0)	8,9 (14.8)	8,2 (13.4)		7,0 —	7,6 (15.7)	8,2 (16.0)	8,5 (14.8)
	68,0 (240)			6,8 (12.7)	5,8 (10.6)	5,1 (9.1)			6,9 —	6,3 (11.5)	5,7 (10.2)
	76,0 (270)			4,9 (6.8)	4,2 (6.5)	3,6 (5.4)				4,6 —	4,1 (6.7)
	84,0 (280)				2,5 (4.9)						2,7 (5.3)

		5° Offset					25° Offset				
Boom m (ft)	Radius	36,6 (120)	51,8 (170)	70,1 (230)	82,3 (270)	91,5 (300)	36,6 (120)	51,8 (170)	70,1 (230)	82,3 (270)	91,5 (300)
Jib Length 24,4 m (80 ft)	13,7 (45)	9,2 (20.5)									
	20,0 (60)	9,0 (20.1)	9,1 (20.3)	9,2 (20.6)							
	26,0 (80)	8,5 (19.3)	8,9 (19.9)	9,1 (20.2)	9,2 (20.4)	9,2 (20.4)	5,8 (12.9)	6,5 (14.5)			
	32,0 (100)	7,8 (17.7)	8,5 (19.2)	8,9 (19.9)	9,0 (20.0)	9,1 (20.1)	5,8 (12.9)	6,5 (14.5)	6,8 (15.2)	6,6 (14.7)	6,2 (13.8)
	40,0 (130)	7,0 (15.6)	7,8 (17.3)	8,4 (18.7)	8,8 (19.5)	8,9 (19.7)	5,7 (12.8)	6,5 (14.4)	6,8 (15.1)	6,6 (14.7)	6,2 (13.8)
	48,0 (150)	6,3 (14.4)	7,1 (16.1)	7,8 (17.7)	8,2 (18.5)	8,5 (19.1)	5,0 (11.5)	5,7 (13.1)	6,4 (14.5)	6,6 (14.7)	6,2 (13.8)
	56,0 (180)	5,7 (12.9)	6,5 (14.6)	7,3 (16.3)	7,7 (17.2)	8,0 (17.8)		5,1 (11.5)	5,7 (13.0)	6,1 (13.8)	6,2 (13.8)
	64,0 (210)		6,0 (13.4)	6,8 (15.1)	6,8 (15.2)	6,2 (13.7)		4,7 (10.4)	5,3 (11.7)	5,6 (12.5)	5,9 (13.1)
	72,0 (240)		5,6 (12.4)	6,0 (12.8)	5,1 (11.0)	4,5 (9.5)			4,9 (10.8)	5,2 (11.5)	5,2 (11.0)
	80,0 (260)			4,5 (10.4)	3,8 (8.7)	3,1 (7.3)				4,2 (9.7)	3,7 (8.5)
	84,0 (280)			3,5 (7.1)	3,0 (6.1)	2,5 (4.9)				3,6 (7.6)	3,1 (6.4)
	88,0 (300)			2,6 (4.0)	2,2 —						2,4 —

Meets ANSI B30.5 Requirements - Capacities do not exceed 75% of static tipping load.
NOTICE: This capacity chart is for reference only and must not be used for lifting purposes.



Fixed jib range diagram

No. 123 Fixed jib on No. 22E Main Boom with Open Throat Top

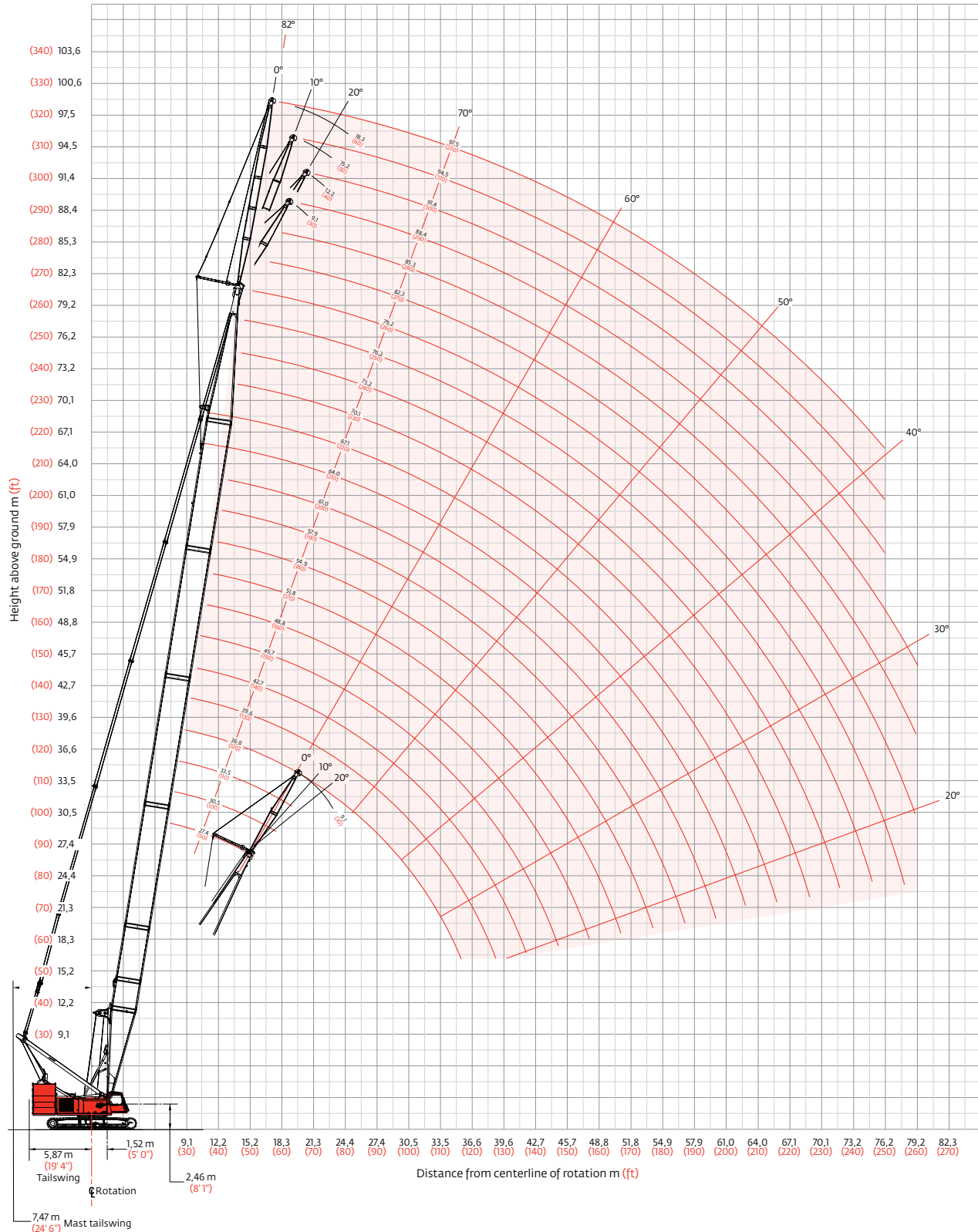



Fixed jib load charts

Liftcrane Boom Capacities Fixed Jib No. 123 with 3 810 mm(12' 6") strut on Boom No. 22E with Open Throat Top

99 609 kg (219,600 lb) Upperworks Counterweight 36 288 kg (80,000 lb) Carbody Counterweight
360° Rating kg (lb) x 1 000

Boom m (ft) Radius	0° Offset					20° Offset				
	27,4 (90)	39,6 (130)	51,8 (170)	64,0 (210)	79,2 (260)	27,4 (90)	39,6 (130)	51,8 (170)	64,0 (210)	79,2 (260)
Jib Length 9,1 m (30 ft)	18,1 (40.0)					18,1 (40.0)				
12,0 (40)	18,1 (40.0)	18,1 (40.0)	— (40.0)			18,1 (40.0)				
16,0 (50)	18,1 (40.0)	18,1 (40.0)	18,1 (40.0)	18,1 (40.0)		18,1 (40.0)	18,1 (40.0)	18,1 (40.0)		
18,0 (60)	18,1 (40.0)	18,1 (40.0)	18,1 (40.0)	18,1 (40.0)	18,1 (40.0)	18,1 (40.0)	18,1 (40.0)	18,1 (40.0)	18,1 (40.0)	
22,0 (75)	18,1 (40.0)	18,1 (40.0)	18,1 (40.0)	18,1 (40.0)	18,1 (40.0)	18,1 (39.8)	18,1 (40.0)	18,1 (40.0)	18,1 (40.0)	18,1 (40.0)
32,0 (100)	18,1 (40.0)	18,1 (40.0)	18,1 (40.0)	18,1 (40.0)	18,1 (40.0)	14,5 (33.0)	16,9 (38.5)	18,1 (40.0)	18,1 (40.0)	18,1 (40.0)
44,0 (140)		15,0 (34.8)	14,2 (33.0)	13,3 (31.0)	12,2 (28.6)		— (31.6)	14,5 (33.7)	13,7 (32.0)	12,8 (29.8)
52,0 (170)			10,8 (24.0)	9,9 (22.0)	8,8 (19.6)			— (24.4)	10,2 (22.7)	9,2 (20.5)
64,0 (210)				6,1 (13.5)	5,3 (11.8)					5,5 (12.3)
72,0 (240)					3,1 (6.2)					3,5 (7.0)
76,2 (250)					— (4.4)					

Boom m (ft) Radius	0° Offset					20° Offset				
	27,4 (90)	39,6 (130)	51,8 (170)	64,0 (210)	79,2 (260)	27,4 (90)	39,6 (130)	51,8 (170)	64,0 (210)	79,2 (260)
Jib Length 12,2 m (40 ft)	13,6 (30.0)									
12,0 (40)	13,6 (30.0)	13,6 (30.0)	— (30.0)							
16,0 (50)	13,6 (30.0)	13,6 (30.0)	13,6 (30.0)	13,6 (30.0)		13,6 (30.0)	13,6 (30.0)			
18,0 (60)	13,6 (30.0)	13,6 (30.0)	13,6 (30.0)	13,6 (30.0)	13,6 (30.0)	13,6 (30.0)	13,6 (30.0)	13,6 (30.0)	— (30.0)	
22,0 (75)	13,6 (30.0)	13,6 (30.0)	13,6 (30.0)	13,6 (30.0)	13,6 (30.0)	13,6 (30.0)	13,6 (30.0)	13,6 (30.0)	13,6 (30.0)	13,6 (30.0)
32,0 (100)	13,6 (30.0)	13,6 (30.0)	13,6 (30.0)	13,6 (30.0)	13,6 (30.0)	11,0 (25.1)	12,7 (29.0)	13,6 (30.0)	13,6 (30.0)	13,6 (30.0)
44,0 (140)	10,9 (—)	13,2 (30.0)	13,6 (30.0)	13,4 (30.0)	12,4 (29.0)		10,4 (23.5)	11,7 (26.3)	12,8 (28.8)	13,0 (30.0)
52,0 (170)		— (23.8)	10,9 (24.3)	10,0 (22.4)	8,9 (19.9)			10,6 (23.5)	10,4 (23.3)	9,5 (21.1)
64,0 (210)				6,5 (14.5)	5,4 (12.1)				6,8 (15.0)	5,8 (12.9)
72,0 (240)				3,7 (7.4)	3,5 (7.1)					4,0 (8.1)
76,2 (250)					— (5.2)					— (6.1)

Meets ANSI B30.5 Requirements - Capacities do not exceed 75% of static tipping load.
NOTICE: This capacity chart is for reference only and must not be used for lifting purposes.



Fixed jib load charts

Liftcrane Boom Capacities

Fixed Jib No. 123 with 3 810 mm(12' 6") strut on Boom No. 22E with Open Throat Top

99 609 kg (219,600 lb) Upperworks Counterweight 36 288 kg (80,000 lb) Carbody Counterweight
360° Rating kg (lb) x 1 000

Boom m (ft) Radius	0° Offset					20° Offset				
	27,4 (90)	39,6 (130)	51,8 (170)	64,0 (210)	79,2 (260)	27,4 (90)	39,6 (130)	51,8 (170)	64,0 (210)	79,2 (260)
Jib Length 15,2 m (50 ft)	9,1 (30)	9,0 (20.0)								
12,0 (40)	9,0 (20.0)	— (20.0)								
16,0 (50)	9,0 (20.0)	9,0 (20.0)	9,0 (20.0)	9,0 (20.0)		9,0 (20.0)				
18,0 (60)	9,0 (20.0)	9,0 (20.0)	9,0 (20.0)	9,0 (20.0)	— (20.0)	9,0 (20.0)	9,0 (20.0)	(20.0)		
22,0 (75)	9,0 (20.0)	9,0 (20.0)	9,0 (20.0)	9,0 (20.0)	9,0 (20.0)	9,0 (20.0)	9,0 (20.0)	9,0 (20.0)	— (20.0)	
32,0 (100)	9,0 (20.0)	9,0 (20.0)	9,0 (20.0)	9,0 (20.0)	9,0 (20.0)	9,0 (20.0)	9,0 (20.0)	9,0 (20.0)	9,0 (20.0)	9,0 (20.0)
44,0 (140)	— (19.7)	9,0 (20.0)	9,0 (20.0)	9,0 (20.0)	9,0 (20.0)		8,6 (19.4)	9,0 (20.0)	9,0 (20.0)	9,0 (20.0)
52,0 (170)		9,0 (20.0)	9,0 (20.0)	9,0 (20.0)	9,0 (20.0)			8,6 (19.2)	9,0 (20.0)	9,0 (20.0)
64,0 (210)			6,9 (15.4)	6,7 (14.9)	5,6 (12.4)				7,0 (15.6)	6,0 (13.4)
72,0 (240)				4,3 (8.8)	3,9 (8.0)					4,3 (9.0)
80,0 (260)					— (4.4)					2,2 (5.5)

Boom m (ft) Radius	0° Offset					20° Offset				
	27,4 (90)	39,6 (130)	51,8 (170)	64,0 (210)	79,2 (260)	27,4 (90)	39,6 (130)	51,8 (170)	64,0 (210)	79,2 (260)
Jib Length 18,3 m (60 ft)	9,1 (30)									
12,0 (40)	4,5 (10.0)	— (10.0)								
16,0 (50)	4,5 (10.0)	4,5 (10.0)	4,5 (10.0)	4,5 (10.0)						
18,0 (60)	4,5 (10.0)	4,5 (10.0)	4,5 (10.0)	4,5 (10.0)	— (10.0)	4,5 (10.0)	— (10.0)			
22,0 (75)	4,5 (10.0)	4,5 (10.0)	4,5 (10.0)	4,5 (10.0)	4,5 (10.0)	4,5 (10.0)	4,5 (10.0)	4,5 (10.0)	4,5 (10.0)	
32,0 (100)	4,5 (10.0)	4,5 (10.0)	4,5 (10.0)	4,5 (10.0)	4,5 (10.0)	4,5 (10.0)	4,5 (10.0)	4,5 (10.0)	4,5 (10.0)	4,5 (10.0)
44,0 (140)	4,5 (10.0)	4,5 (10.0)	4,5 (10.0)	4,5 (10.0)	4,5 (10.0)	— (10.0)	4,5 (10.0)	4,5 (10.0)	4,5 (10.0)	4,5 (10.0)
52,0 (170)		4,5 (10.0)	4,5 (10.0)	4,5 (10.0)	4,5 (10.0)		— (10.0)	4,5 (10.0)	4,5 (10.0)	4,5 (10.0)
64,0 (210)			4,5 (10.0)	4,5 (10.0)	4,5 (10.0)				4,5 (10.0)	4,5 (10.0)
72,0 (240)				4,5 (9.7)	4,0 (8.5)					4,4 (9.4)
80,0 (260)				2,3 (5.7)	2,0 (5.0)					2,7 (6.4)
70,0 (270)										— (4.7)

Meets ANSI B30.5 Requirements - Capacities do not exceed 75% of static tipping load.
NOTICE: This capacity chart is for reference only and must not be used for lifting purposes.



Fixed jib range diagram

No. 123 Fixed Jib on No. 22E Main Boom with Light Tapered Top

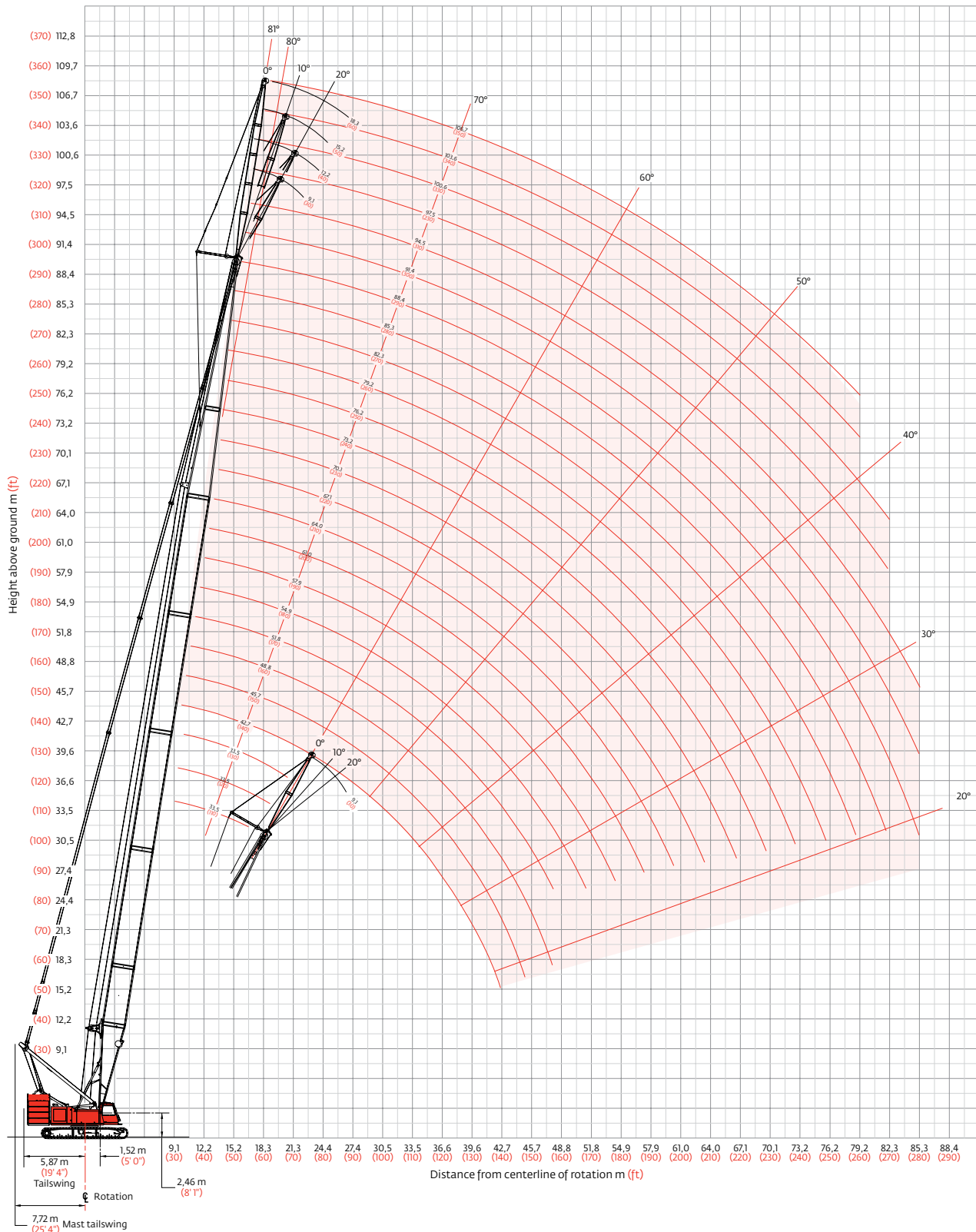



Fixed jib load charts

Liftcrane Boom Capacities Fixed Jib No. 123 with 3 810 mm(12' 6") strut on Boom No. 22E with Open Throat Top

		99 609 kg (219,600 lb) Upperworks Counterweight 36 288 kg (80,000 lb) Carbody Counterweight 360° Rating kg (lb) x 1 000									
		0° Offset					20° Offset				
Boom m (ft)	Radius	33,5 (110)	48,8 (160)	61,0 (200)	73,2 (240)	88,4 (290)	33,5 (110)	48,8 (160)	61,0 (200)	73,2 (240)	88,4 (290)
Jib Length 9,1 m (30 ft)	9,1 (30)	18,1 (40.0)									
	12,0 (40)	18,1 (40.0)	— (40.0)				— (40.0)				
	16,0 (55)	18,1 (40.0)	18,1 (40.0)	18,1 (40.0)	18,1 (40.0)		18,1 (40.0)	18,1 (40.0)	— (40.0)		
	20,0 (70)	18,1 (40.0)	18,1 (40.0)	18,1 (40.0)	18,1 (40.0)	18,1 (40.0)	18,1 (40.0)	18,1 (40.0)	18,1 (40.0)	18,1 (40.0)	— (40.0)
	28,0 (90)	18,1 (40.0)	18,1 (40.0)	18,1 (40.0)	18,1 (40.0)	18,1 (40.0)	16,8 (37.7)	18,1 (40.0)	18,1 (40.0)	18,1 (40.0)	18,1 (40.0)
	36,0 (120)	17,5 (37.9)	16,5 (35.5)	15,6 (33.8)	14,8 (31.9)	13,8 (29.7)	14,4 (31.6)	16,8 (36.3)	16,1 (34.7)	15,3 (33.0)	14,4 (31.0)
	48,0 (150)		10,6 (25.4)	9,8 (23.6)	9,0 (21.7)	7,9 (19.5)		10,8 (25.8)	10,1 (24.3)	9,3 (22.6)	8,4 (20.5)
	56,0 (180)		8,2 (18.8)	7,4 (17.1)	6,5 (15.2)	5,5 (12.9)			7,6 (17.5)	6,8 (15.7)	5,8 (13.6)
	68,0 (220)			4,8 (11.1)	4,0 (9.3)	3,0 (7.0)				4,1 (9.6)	3,2 (7.5)
	76,0 (250)				2,7 (6.1)						1,9 (4.2)
84,0 (280)											

		0° Offset					20° Offset				
Boom m (ft)	Radius	33,5 (110)	48,8 (160)	61,0 (200)	73,2 (240)	88,4 (290)	33,5 (110)	48,8 (160)	61,0 (200)	73,2 (240)	88,4 (290)
Jib Length 12,2 m (40 ft)	9,1 (30)										
	12,0 (40)	13,6 (30.0)									
	16,0 (55)	13,6 (30.0)	13,6 (30.0)	13,6 (30.0)	— (30.0)		13,6 (30.0)	— (30.0)			
	20,0 (70)	13,6 (30.0)	13,6 (30.0)	13,6 (30.0)	13,6 (30.0)	13,6 (30.0)	13,6 (30.0)	13,6 (30.0)	13,6 (30.0)	13,6 (30.0)	
	28,0 (90)	13,6 (30.0)	13,6 (30.0)	13,6 (30.0)	13,6 (30.0)	13,6 (30.0)	12,8 (28.7)	13,6 (30.0)	13,6 (30.0)	13,6 (30.0)	13,6 (30.0)
	36,0 (120)	13,6 (30.0)	13,6 (30.0)	13,6 (30.0)	13,6 (30.0)	13,5 (29.9)	10,8 (23.8)	12,7 (27.8)	13,6 (30.0)	13,6 (30.0)	13,6 (30.0)
	48,0 (150)	— (24.4)	10,7 (25.7)	9,9 (23.9)	9,1 (22.0)	8,0 (19.7)		10,7 (24.2)	10,3 (24.7)	9,5 (23.1)	8,6 (21.1)
	56,0 (180)		8,3 (19.0)	7,5 (17.3)	6,6 (15.4)	5,6 (13.1)			7,7 (17.9)	7,0 (16.2)	6,0 (14.1)
	68,0 (220)			4,9 (11.3)	4,1 (9.5)	3,0 (7.2)				4,3 (10.0)	3,4 (7.9)
	76,0 (250)				2,8 (6.3)	1,8 (4.0)					2,1 (4.6)
84,0 (280)											

Meets ANSI B30.5 Requirements - Capacities do not exceed 75% of static tipping load.
NOTICE: This capacity chart is for reference only and must not be used for lifting purposes.



Fixed jib load charts

Liftcrane Boom Capacities
Fixed Jib No. 123 with 3 810 mm (12' 6") strut on
Boom No. 22E with Light Tapered Top

99 609 kg (219,600 lb) Upperworks Counterweight 36 288 kg (80,000 lb) Carbody Counterweight
 360° Rating kg (lb) x 1 000

Boom m (ft) Radius	0° Offset					20° Offset				
	33,5 (110)	48,8 (160)	61,0 (200)	73,2 (240)	88,4 (290)	33,5 (110)	48,8 (160)	61,0 (200)	73,2 (240)	88,4 (290)
Jib Length 15,2 m (50 ft)	9,1 (30)									
	12,0 (40)	9,0 (20.0)								
	16,0 (55)	9,0 (20.0)	9,0 (20.0)	9,0 (20.0)	— (20.0)	9,0 (20.0)				
	20,0 (70)	9,0 (20.0)	9,0 (20.0)	9,0 (20.0)	9,0 (20.0)	9,0 (20.0)	9,0 (20.0)	9,0 (20.0)	— (20.0)	
	28,0 (90)	9,0 (20.0)	9,0 (20.0)	9,0 (20.0)	9,0 (20.0)	9,0 (20.0)	9,0 (20.0)	9,0 (20.0)	9,0 (20.0)	9,0 (20.0)
	36,0 (120)	9,0 (20.0)	9,0 (20.0)	9,0 (20.0)	9,0 (20.0)	9,0 (20.0)	9,0 (19.8)	9,0 (20.0)	9,0 (20.0)	9,0 (20.0)
	48,0 (150)	8,9 (20.0)	9,0 (20.0)	9,0 (20.0)	9,0 (20.0)	8,2 (20.0)	8,7 (20.0)	9,0 (20.0)	9,0 (20.0)	8,8 (20.0)
	56,0 (180)		8,4 (19.3)	7,6 (17.5)	6,7 (15.6)	5,7 (13.3)	— (17.8)	7,9 (18.3)	7,2 (16.7)	6,3 (14.7)
	68,0 (220)			5,0 (11.6)	4,2 (9.7)	3,1 (7.4)			4,5 (10.4)	3,5 (8.3)
	76,0 (250)				2,9 (6.5)	1,9 (4.3)				2,2 (5.0)
	84,0 (280)				1,9 (4.0)					

Boom m (ft) Radius	0° Offset					20° Offset					
	33,5 (110)	48,8 (160)	61,0 (200)	73,2 (240)	88,4 (290)	33,5 (110)	48,8 (160)	61,0 (200)	73,2 (240)	88,4 (290)	
Jib Length 18,3 m (60 ft)	9,1 (30)										
	12,0 (40)	4,5 (10.0)									
	16,0 (55)	4,5 (10.0)	4,5 (10.0)	4,5 (10.0)	— (10.0)	— (10.0)					
	20,0 (70)	4,5 (10.0)	4,5 (10.0)	4,5 (10.0)	4,5 (10.0)	4,5 (10.0)	4,5 (10.0)	— (10.0)			
	28,0 (90)	4,5 (10.0)	4,5 (10.0)	4,5 (10.0)	4,5 (10.0)	4,5 (10.0)	4,5 (10.0)	4,5 (10.0)	4,5 (10.0)	4,5 (10.0)	
	36,0 (120)	4,5 (10.0)	4,5 (10.0)	4,5 (10.0)	4,5 (10.0)	4,5 (10.0)	4,5 (10.0)	4,5 (10.0)	4,5 (10.0)	4,5 (10.0)	
	48,0 (150)	4,5 (10.0)	4,5 (10.0)	4,5 (10.0)	4,5 (10.0)	4,5 (10.0)	— (10.0)	4,5 (10.0)	4,5 (10.0)	4,5 (10.0)	
	56,0 (180)		4,5 (10.0)	4,5 (10.0)	4,5 (10.0)	4,5 (10.0)		4,5 (10.0)	4,5 (10.0)	4,5 (10.0)	
	68,0 (220)			4,5 (10.0)	4,2 (9.8)	3,2 (7.5)			4,5 (10.0)	4,5 (10.0)	3,7 (8.6)
	76,0 (250)			3,8 (8.5)	3,0 (6.7)	1,9 (4.3)				3,3 (7.2)	2,3 (5.2)
	84,0 (280)				2,0 (4.2)						

Meets ANSI B30.5 Requirements - Capacities do not exceed 75% of static tipping load.
 NOTICE: This capacity chart is for reference only and must not be used for lifting purposes.



Luffing jib range diagram

No. 135 Luffing Jib on No. 82 or No. 22EL Main Boom

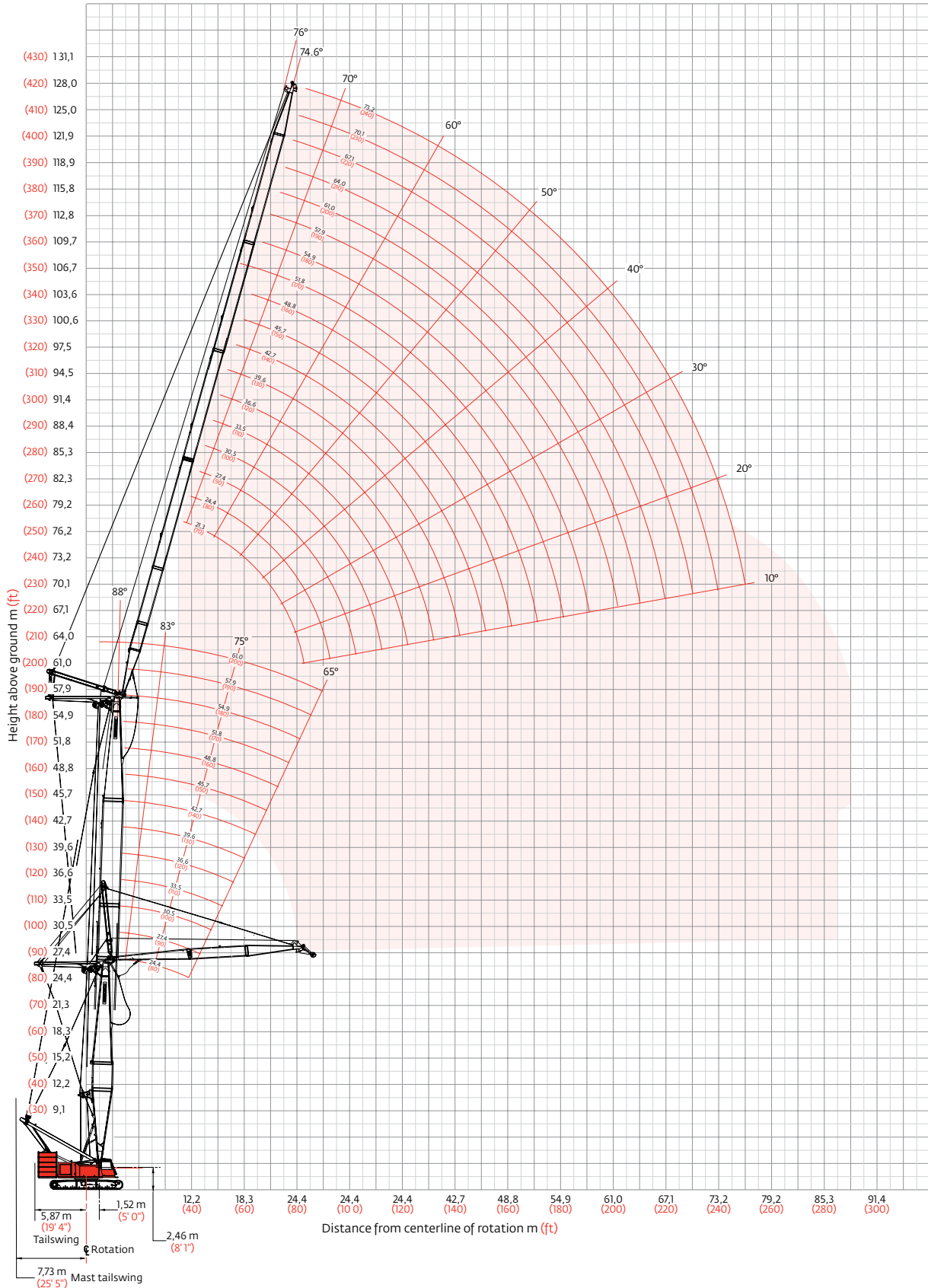



Luffing jib load charts

Liftcrane Luffing Jib Capacities - Series 3 Luffing Jib No. 135 on Boom No. 82 or No. 22EL

99 609 kg (219,600 lb) Upperworks Counterweight 36 288 kg (80,000 lb) Carbody Counterweight
360° Rating kg (lb) x 1 000

88° Boom Angle

Luffing Jib Length	Boom m (ft) Radius	21,3 (70)	30,5 (100)	42,7 (140)	51,8 (170)	61,0 (200)
	21,3 m (70 ft)	12,2 (40)	46,1 (101.8)			
14,0 (45)		43,5 (96.7)	43,7 (96.9)	44,1 (98.0)		
16,0 (50)		41,7 (93.8)	41,8 (94.1)	41,7 (93.9)	39,8 (89.4)	35,3 (80.2)
18,0 (60)		38,7 (84.3)	39,6 (86.9)	39,7 (87.1)	38,0 (83.3)	32,6 (71.1)
22,0 (70)		28,7 (68.3)	30,8 (71.6)	31,8 (73.5)	31,0 (71.1)	27,7 (62.7)
24,0 (80)			23,7 (47.6)	25,4 (51.8)	26,3 (55.1)	25,6 (55.7)
26,0 (90)						
28,0 (100)						
30,0 (105)						
32,0 (110)						

Luffing Jib Length	Boom m (ft) Radius	21,3 (70)	30,5 (100)	42,7 (140)	51,8 (170)	61,0 (200)
	30,5 m (100 ft)	12,2 (40)	35,3 (77.9)	35,1 (77.6)		
14,0 (45)		33,8 (75.3)	33,8 (75.1)	33,3 (74.2)	31,9 (70.7)	
16,0 (50)		31,7 (71.7)	31,7 (71.6)	31,5 (71.0)	31,1 (69.8)	25,1 (55.9)
18,0 (60)		29,8 (65.2)	29,9 (65.4)	29,8 (65.2)	29,4 (64.5)	24,4 (53.8)
22,0 (70)		26,5 (59.6)	26,6 (59.9)	26,7 (60.1)	26,6 (59.8)	23,2 (51.9)
24,0 (80)		25,1 (54.9)	25,3 (55.3)	25,4 (55.7)	25,2 (55.1)	21,8 (47.5)
26,0 (90)		23,8 (49.2)	24,1 (48.1)	24,3 (51.9)	23,4 (48.6)	20,3 (42.7)
28,0 (100)		21,7 (42.3)	22,8 (44.9)	23,1 (45.7)	21,5 (43.0)	18,9 (38.4)
30,0 (105)		19,6 (35.4)	20,8 (41.9)	21,2 (42.8)	19,8 (40.5)	17,7 (36.6)
32,0 (110)		16,0 (—)	19,0 (33.0)	19,4 (35.6)	18,3 (38.2)	16,6 (35.2)

Luffing Jib Length	Boom m (ft) Radius	21,3 (70)	30,5 (100)	42,7 (140)	51,8 (170)	61,0 (200)
	42,7 m (140 ft)	3,7 (45)	23,7 (52.3)	23,4 (51.6)		
16,0 (50)		22,2 (50.1)	22,1 (49.8)	21,6 (48.3)	20,7 (46.2)	19,7 (43.8)
18,0 (60)		20,9 (45.9)	20,9 (45.8)	20,7 (45.3)	20,2 (44.6)	19,3 (42.5)
22,0 (70)		18,6 (42.0)	18,7 (42.1)	18,7 (42.0)	18,5 (41.6)	17,9 (40.1)
24,0 (80)		17,6 (38.5)	17,7 (38.7)	17,7 (38.8)	17,6 (38.6)	17,2 (37.6)
30,0 (100)		14,8 (32.4)	15,0 (32.7)	15,1 (33.0)	15,2 (33.2)	14,8 (32.3)
38,0 (120)		12,0 (27.5)	12,1 (27.8)	12,3 (28.2)	12,5 (28.5)	11,8 (27.3)
44,0 (140)		9,4 (23.8)	10,6 (24.0)	10,7 (24.4)	10,8 (24.7)	10,1 (23.1)
50,0 (160)						
54,0 (180)						

Luffing Jib Length	Boom m (ft) Radius	21,3 (70)	30,5 (100)	42,7 (140)	51,8 (170)	61,0 (200)
	51,8 m (170 ft)	13,7 (45)				
16,0 (50)						
18,0 (60)		16,5 (36.2)	16,5 (36.1)	16,2 (35.6)	15,9 (35.0)	— (32.3)
22,0 (70)		14,6 (32.9)	14,6 (32.9)	14,6 (32.8)	14,4 (32.4)	13,9 (31.0)
24,0 (80)		13,7 (29.8)	13,7 (30.0)	13,7 (30.0)	13,7 (29.9)	13,5 (29.6)
30,0 (100)		11,2 (24.4)	11,3 (24.7)	11,4 (24.9)	11,5 (25.1)	11,5 (25.1)
38,0 (120)		8,6 (19.9)	8,6 (20.1)	8,8 (20.5)	9,0 (20.7)	9,1 (21.0)
44,0 (140)		6,9 (16.1)	7,0 (16.4)	7,2 (16.7)	7,3 (17.0)	7,4 (17.3)
50,0 (160)		5,6 (13.1)	5,7 (13.3)	5,9 (13.6)	6,0 (13.9)	6,1 (14.2)
54,0 (180)			4,8 (10.2)	4,9 (10.6)	5,1 (10.9)	5,2 (11.2)

Meets ANSI B30.5 Requirements - Capacities do not exceed 75% of static tipping load.
NOTICE: This capacity chart is for reference only and must not be used for lifting purposes.



Luffing jib load charts

Liftcrane Luffing Jib Capacities - Series 3 Luffing Jib No. 135 on Boom No. 82 or No. 22EL

99 609 kg (219,600 lb) Upperworks Counterweight 36 288 kg (80,000 lb) Carbody Counterweight
360° Rating kg (lb) x 1 000
75° Boom Angle

Luffing jib Length 21,3 m (70 ft)	Boom m (ft) Radius	21,3 (70)	30,5 (100)	42,7 (140)	51,8 (170)	61,0 (200)
	20,0 (60)	43,4 (100.4)	44,8 —			
22,0 (70)	40,8 (92.5)	39,8 (91.3)				
24,0 (80)	36,0 (77.0)	35,8 (77.5)	— (73.7)			
28,0 (90)	26,6 (63.1)	29,7 (67.2)	28,2 (63.8)	26,8 (60.8)		
30,0 (100)		27,2 (59.0)	25,9 (56.1)	24,7 (53.5)	23,6 (51.2)	
34,0 (110)		27,2 (59.0)	— (49.8)	21,1 (47.5)	20,2 (45.5)	
36,0 (120)				19,7 (42.6)	18,8 (40.8)	
42,0 (140)						
44,0 (150)						
46,0 (155)						

Luffing jib Length 30,5 m (100 ft)	Boom m (ft) Radius	21,3 (70)	30,5 (100)	42,7 (140)	51,8 (170)	61,0 (200)
	20,0 (60)					
22,0 (70)						
24,0 (80)	29,2 (63.8)	— (67.6)				
28,0 (90)	26,3 (58.9)	27,9 (62.6)	27,8 (62.8)			
30,0 (100)	24,9 (54.0)	26,6 (58.1)	25,5 (55.2)	(52.4)		
34,0 (110)	20,5 (46.3)	23,1 (51.9)	21,8 (49.1)	20,7 (46.6)	19,7 (44.4)	
36,0 (120)	18,6 (40.1)	21,5 (46.4)	20,4 (44.1)	19,3 (41.8)	18,4 (39.9)	
42,0 (140)			16,7 (36.3)	15,9 (34.4)	15,1 (32.8)	
44,0 (150)				15,0 (31.4)	14,2 (30.0)	
46,0 (155)					13,4 (28.7)	

Luffing jib Length 42,7 m (140 ft)	Boom m (ft) Radius	21,3 (70)	30,5 (100)	42,7 (140)	51,8 (170)	61,0 (200)
	28,0 (90)	18,0 (40.4)				
30,0 (100)	17,1 (37.3)	— (39.5)				
34,0 (110)	15,4 (34.4)	16,4 (36.6)	17,5 (39.1)			
38,0 (120)	13,8 (31.7)	14,7 (33.8)	16,0 (36.6)	16,7 (38.0)		
42,0 (140)	12,4 (27.0)	13,3 (28.9)	14,5 (31.6)	15,4 (33.4)	14,6 (31.7)	
46,0 (150)	11,3 (25.1)	12,0 (26.7)	13,1 (29.3)	13,7 (30.6)	13,0 (29.0)	
50,0 (160)	9,3 (23.6)	10,9 (24.9)	11,9 (27.2)	12,3 (28.1)	11,6 (26.6)	
54,0 (180)			10,9 (23.9)	11,1 (24.0)	10,5 (22.7)	
60,0 (200)						
68,0 (220)						

Luffing jib Length 51,8 m (170 ft)	Boom m (ft) Radius	21,3 (70)	30,5 (100)	42,7 (140)	51,8 (170)	61,0 (200)
	28,0 (90)					
30,0 (100)						
34,0 (110)	11,5 (25.9)					
38,0 (120)	10,1 (23.5)	11,0 (25.3)				
42,0 (140)	8,9 (19.2)	9,6 (20.9)	10,7 (23.2)	11,4 (24.7)	— (25.4)	
46,0 (150)	7,7 (17.3)	8,4 (18.9)	9,4 (21.1)	10,2 (22.8)	10,8 (24.1)	
50,0 (160)	6,7 (15.6)	7,4 (17.0)	8,3 (19.1)	9,1 (20.8)	9,8 (22.4)	
54,0 (180)	5,8 (12.5)	6,4 (13.8)	7,3 (15.6)	8,0 (17.2)	8,7 (18.7)	
60,0 (200)		5,0 (10.6)	5,9 (12.5)	6,5 (14.0)	7,2 (15.5)	
68,0 (220)				— (10.8)	5,3 (12.3)	

Meets ANSI B30.5 Requirements - Capacities do not exceed 75% of static tipping load.
NOTICE: This capacity chart is for reference only and must not be used for lifting purposes.



Luffing jib load charts

Liftcrane Luffing Jib Capacities - Series 3 Luffing Jib No. 135 on Boom No. 82 or No. 22EL

99 609 kg (219,600 lb) Upperworks Counterweight 36 288 kg (80,000 lb) Carbody Counterweight
360° Rating kg (lb) x1 000

60° Boom Angle

Luffing Jib Length	Boom m (ft) Radius	21,3 (70)	30,5 (100)	42,7 (140)	51,8 (170)	61,0 (200)
	Luffing Jib Length 21,3 m (70 ft)	28,0 (90)	28,4 (64.3)			
30,0 (100)		26,1 (56.5)				
34,0 (110)		— (50.2)	20,7 (46.6)			
38,0 (120)			18,0 (41.8)			
42,0 (140)				14,0 (30.3)	— (26.6)	
46,0 (150)					10,8 (24.2)	
50,0 (160)					— (22.1)	8,5 (19.5)
54,0 (180)						
60,0 (200)						
64,0 (210)						

Luffing Jib Length	Boom m (ft) Radius	21,3 (70)	30,5 (100)	42,7 (140)	51,8 (170)	61,0 (200)
	Luffing Jib Length 30,5 m (100 ft)	28,0 (90)				
30,0 (100)						
34,0 (110)		21,4 (47.6)				
38,0 (120)		19,2 (44.4)				
42,0 (140)		16,9 (36.5)	15,6 (33.7)			
46,0 (150)			13,8 (30.8)	12,0 (26.7)		
50,0 (160)				10,7 (24.5)	9,2 (21.1)	
54,0 (180)					8,2 (17.9)	7,1 (15.3)
60,0 (200)						6,0 (13.0)
64,0 (210)						

Luffing Jib Length	Boom m (ft) Radius	21,3 (70)	30,5 (100)	42,7 (140)	51,8 (170)	61,0 (200)
	Luffing Jib Length 42,7 m (140 ft)	44,0 (140)	13,3 (30.3)			
46,0 (145)		12,7 (29.3)				
50,0 (150)		11,6 (28.3)	12,0 —			
54,0 (160)		10,7 (26.3)	10,8 (27.4)	9,1 —		
58,0 (180)		— (23.5)	9,7 (23.3)	8,2 (19.8)	6,9 —	
62,0 (200)				7,5 (17.0)	6,2 (14.2)	
66,0 (220)					5,6 (12.2)	4,7 (10.1)
72,0 (240)						3,9 (8.5)
76,0 (260)						
80,0 (270)						

Luffing Jib Length	Boom m (ft) Radius	21,3 (70)	30,5 (100)	42,7 (140)	51,8 (170)	61,0 (200)
	Luffing Jib Length 51,8 m (170 ft)	44,0 (140)				
46,0 (145)						
50,0 (150)		8,0 —				
54,0 (160)		7,0 (18.3)	8,1 —			
58,0 (180)		6,1 (15.1)	7,1 (17.5)			
62,0 (200)		5,1 (11.9)	6,3 (14.4)	7,2 (16.3)		
66,0 (220)			5,3 (11.3)	6,5 (14.0)	5,3 (11.4)	
72,0 (240)				5,4 (11.5)	4,5 (9.8)	3,6 (7.8)
76,0 (260)					4,1 (8.3)	3,2 (6.5)
80,0 (270)						2,8 (6.0)

Meets ANSI B30.5 Requirements - Capacities do not exceed 75% of static tipping load.
NOTICE: This capacity chart is for reference only and must not be used for lifting purposes.



Luffing jib range diagram

No. 149 Luffing Jib on No. 82 Main Boom

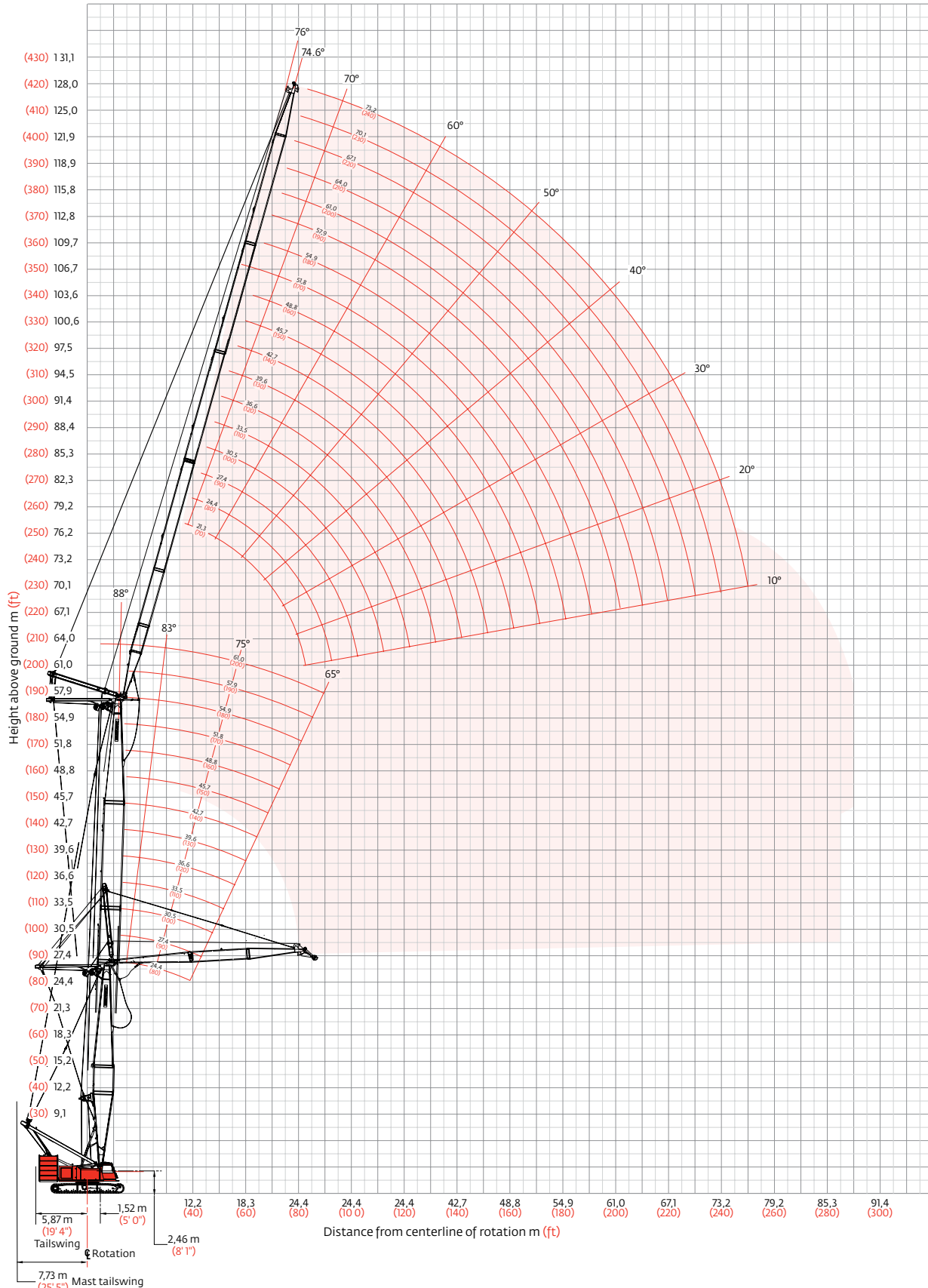



Luffing jib load charts

Liftcrane Luffing Jib Capacities - Series 3 Luffing Jib No. 149 on Boom No. 82

99 609 kg (219,600 lb) Upperworks Counterweight 36 288 kg (80,000 lb) Carbody Counterweight
360° Rating kg (lb) x 1 000

88° Boom Angle

Luffing Jib Length 21,3 m (70 ft)	Boom m (ft) Radius	24,4 (80)	36,6 (120)	42,7 (140)	54,9 (180)	61,0 (200)
	11,0 (36)	72,5 (160.0)				
14,0 (40)	59,1 (145.1)	54,4 (131.9)	53,7 —	40,6 —		
16,0 (45)	52,7 (132.5)	49,3 (121.7)	49,1 (120.1)	38,8 (90.3)	32,5 —	
18,0 (55)	46,8 (111.7)	45,1 (105.1)	45,2 (104.9)	37,3 (84.3)	31,1 (70.5)	
20,0 (70)	40,7 (82.5)	41,6 (87.4)	41,2 (84.1)	34,0 (70.3)	30,1 (62.4)	
24,0 (80)	25,7 (49.9)	32,3 (65.8)	31,7 (66.7)	28,8 (63.1)	25,6 (56.1)	
28,0 (100)						
30,0 (110)						
34,0 (120)						
38,0 (130)						

Luffing Jib Length 36,6 m (120 ft)	Boom m (ft) Radius	24,4 (80)	36,6 (120)	42,7 (140)	54,9 (180)	61,0 (200)
	11,0 (36)					
14,0 (40)	51,4 —	44,1 —	38,5 —	28,6 —		
16,0 (45)	48,8 (115.0)	42,7 (97.5)	36,9 (85.5)	27,5 (63.5)	23,8 —	
18,0 (55)	42,8 (99.8)	39,5 (91.5)	35,7 (81.1)	26,7 (59.9)	22,9 (51.9)	
20,0 (70)	39,2 (81.3)	36,5 (76.8)	34,3 (72.2)	25,4 (55.6)	22,3 (47.4)	
24,0 (80)	31,4 (67.8)	31,6 (68.8)	28,6 (61.9)	23,4 (50.9)	20,5 (44.6)	
28,0 (100)	25,3 (49.8)	25,7 (50.0)	23,4 (45.8)	19,6 (39.1)	17,4 (34.7)	
30,0 (110)	23,0 (43.5)	23,2 (43.4)	21,2 (40.0)	18,1 (34.5)	16,0 (30.9)	
34,0 (120)	19,3 (38.5)	19,2 (38.5)	17,7 (35.7)	15,3 (31.2)	13,7 (28.0)	
38,0 (130)	15,8 (25.1)	16,7 (34.4)	15,5 (33.7)	13,6 (29.5)	12,2 (26.4)	

Luffing Jib Length 51,8 m (170 ft)	Boom m (ft) Radius	24,4 (80)	36,6 (120)	42,7 (140)	54,9 (180)	61,0 (200)
	18,0 (55)	32,2 (71.5)	26,8 (59.9)	24,2 (54.2)		
22,0 (60)	31,5 (70.9)	25,9 (59.1)	23,1 (53.4)	18,2 (42.2)	15,9 (36.8)	
26,0 (75)	27,6 (68.9)	24,8 (56.7)	22,2 (50.8)	17,2 (39.7)	15,0 (34.4)	
30,0 (100)	22,4 (48.3)	21,5 (46.5)	19,3 (41.9)	15,9 (34.4)	13,9 (30.1)	
36,0 (125)	17,0 (34.5)	16,9 (34.5)	15,3 (31.3)	12,8 (26.2)	11,2 (23.1)	
44,0 (150)	12,4 (25.7)	12,5 (26.1)	11,4 (23.8)	9,7 (20.4)	8,6 (18.1)	
52,0 (180)	9,2 (12.7)	9,9 (18.7)	9,1 (18.6)	7,9 (17.1)	7,0 (15.1)	
60,0 (200)						
68,0 (230)						
76,0 (250)						

Luffing Jib Length 73,2 m (240 ft)	Boom m (ft) Radius	24,4 (80)	36,6 (120)	42,7 (140)	54,9 (180)
	18,0 (55)				
22,0 (60)	15,7 —				
26,0 (75)	15,2 (34.5)	13,6 (30.8)	12,7 (28.7)	10,5 (23.7)	
30,0 (100)	14,7 (32.4)	13,2 (29.2)	12,3 (27.2)	10,1 (22.2)	
36,0 (125)	14,0 (30.5)	12,7 (27.5)	11,7 (24.8)	9,5 (20.1)	
44,0 (150)	11,0 (22.7)	10,6 (22.4)	9,5 (20.1)	7,7 (16.3)	
52,0 (180)	7,9 (15.5)	8,5 (17.4)	7,6 (15.5)	6,1 (12.6)	
60,0 (200)	5,6 (12.0)	6,8 (14.5)	6,1 (13.3)	5,0 (10.8)	
68,0 (230)	3,9 (7.9)	4,9 (10.0)	5,1 (10.7)	4,2 (9.0)	
76,0 (250)		2,7 (5.8)	2,6 (5.6)	3,0 (6.5)	

Meets ANSI B30.5 Requirements - Capacities do not exceed 75% of static tipping load.
NOTICE: This capacity chart is for reference only and must not be used for lifting purposes.



Luffing jib load charts

Liftcrane Luffing Jib Capacities - Series 3 Luffing Jib No. 149 on Boom No. 82

99 609 kg (219,600 lb) Upperworks Counterweight 36 288 kg (80,000 lb) Carbody Counterweight
360° Rating kg (lb) x1 000

83° Boom Angle

Luffing Jib Length 21,3 m (70 ft)	Boom m (ft) Radius	24,4 (80)	36,6 (120)	42,7 (140)	54,9 (180)	61,0 (200)
	13,7 (45)	— (148.7)				
16,0 (50)	58,9 (135.7)					
18,0 (60)	52,7 (114.5)	51,5 (112.0)	52,2 (113.6)			
20,0 (70)	47,2 (94.7)	46,5 (94.4)	46,0 (93.5)	43,8 (91.3)	39,0 (82.8)	
22,0 (80)	41,0 (77.8)	41,1 (79.8)	40,7 (79.0)	40,0 (77.2)	36,7 (72.8)	
26,0 (90)		33,3 (68.6)	33,0 (68.0)	32,2 (66.5)	30,5 (63.1)	
30,0 (100)					25,5 (55.2)	
32,0 (120)						
38,0 (140)						
44,0 (150)						

Luffing Jib Length 36,6 m (120 ft)	Boom m (ft) Radius	24,4 (80)	36,6 (120)	42,7 (140)	54,9 (180)	61,0 (200)
	13,7 (45)					
16,0 (50)						
18,0 (60)	— (102.4)					
20,0 (70)	43,1 (89.8)	41,3 (86.8)	41,5 (87.6)	— (71.8)		
22,0 (80)	39,6 (76.8)	38,4 (77.6)	38,8 (77.3)	32,5 (70.7)	— (59.6)	
26,0 (90)	31,6 (64.4)	32,7 (67.4)	32,3 (66.6)	31,3 (64.8)	26,5 (57.5)	
30,0 (100)	25,5 (55.0)	27,2 (58.9)	26,9 (58.2)	26,2 (56.6)	24,5 (52.8)	
32,0 (120)	23,2 (41.8)	25,0 (46.5)	24,8 (46.0)	24,1 (44.7)	22,5 (41.6)	
38,0 (140)	17,8 —	20,0 (37.0)	19,8 (37.4)	19,2 (36.3)	17,8 (33.6)	
44,0 (150)				15,7 —	14,5 (30.3)	

Luffing Jib Length 51,8 m (170 ft)	Boom m (ft) Radius	24,4 (80)	36,6 (120)	42,7 (140)	54,9 (180)	61,0 (200)
	24,0 (75)	32,5 (74.6)				
30,0 (80)	25,0 (70.8)	26,0 (65.5)	26,0 —	21,3 —	18,4 —	
36,0 (90)	18,7 (63.4)	20,7 (62.0)	20,5 (59.8)	19,8 (47.1)	17,3 (41.0)	
42,0 (110)	14,5 (46.3)	16,8 (50.4)	16,6 (49.7)	15,9 (46.5)	14,5 (40.0)	
48,0 (130)	11,5 (35.4)	13,6 (40.2)	13,7 (39.7)	13,0 (38.3)	11,7 (34.4)	
54,0 (160)	9,3 (24.8)	11,0 (29.3)	11,5 (29.6)	10,8 (28.1)	9,6 (25.3)	
60,0 (190)		— (20.4)	— (21.5)	— (21.2)	7,9 (18.8)	
66,0 (220)						
70,0 (240)						
74,0 (260)						

Luffing Jib Length 73,2 m (240 ft)	Boom m (ft) Radius	24,4 (80)	36,6 (120)	42,7 (140)	54,9 (180)
	24,0 (75)				
30,0 (80)					
36,0 (90)	16,1 —	14,7 —	13,9 —	11,7 —	
42,0 (110)	13,2 (36.1)	14,3 (32.9)	13,6 (31.0)	11,5 (26.0)	
48,0 (130)	10,2 (32.6)	12,3 (32.1)	12,5 (30.4)	10,7 (25.6)	
54,0 (160)	7,9 (21.8)	9,7 (26.4)	10,3 (27.0)	9,1 (23.3)	
60,0 (190)	6,1 (14.9)	7,7 (18.4)	8,3 (20.0)	7,3 (17.5)	
66,0 (220)	4,7 (10.0)	6,1 (12.9)	6,7 (14.2)	5,9 (12.6)	
74,0 (240)	3,2 (7.5)	4,3 (10.0)	4,9 (11.3)	4,3 (10.0)	
80,0 (265)				3,4 (7.3)	

Meets ANSI B30.5 Requirements - Capacities do not exceed 75% of static tipping load.
NOTICE: This capacity chart is for reference only and must not be used for lifting purposes.



Luffing jib load charts

Liftcrane Luffing Jib Capacities - Series 3 Luffing Jib No. 149 on Boom No. 82

99 609 kg (219,600 lb) Upperworks Counterweight 36 288 kg (80,000 lb) Carbody Counterweight
360° Rating kg (lb) x 1 000

75° Boom Angle

Luffing Jib Length 21,3 m (70 ft)	Boom m (ft) Radius	24,4 (80)	36,6 (120)	42,7 (140)	54,9 (180)	61,0 (200)
	19,8 (65)	— (100.4)				
22,0 (70)	39,8 (91.4)					
26,0 (80)	32,3 (77.3)	30,8 (73.7)	30,0 (71.7)			
30,0 (100)		25,7 (55.6)	25,0 (54.1)	23,3 (50.5)	22,4 (48.5)	
34,0 (120)				19,8 (39.7)	19,0 (38.2)	
38,0 (130)					16,4 —	
42,0 (140)						
46,0 (150)						
48,0 (160)						
52,0 (170)						

Luffing Jib Length 36,6 m (120 ft)	Boom m (ft) Radius	24,4 (80)	36,6 (120)	42,7 (140)	54,9 (180)	61,0 (200)
	19,8 (65)					
22,0 (70)						
26,0 (80)	31,5 —					
30,0 (100)	26,2 (56.7)	24,8 (53.6)	— (51.9)			
34,0 (120)	22,3 (44.8)	21,1 (42.3)	20,4 (40.9)	18,8 (37.7)	— (35.9)	
38,0 (130)	19,3 (40.3)	18,2 (38.0)	17,6 (36.7)	16,2 (33.8)	15,4 (32.1)	
42,0 (140)	16,8 (36.4)	15,9 (34.3)	15,3 (33.2)	14,1 (30.5)	13,4 (29.0)	
46,0 (150)		14,0 (31.2)	13,5 (30.1)	12,4 (27.6)	11,7 (26.2)	
48,0 (160)			12,7 (27.4)	11,6 (25.1)	11,0 (23.9)	
52,0 (170)				— (22.9)	9,7 (21.7)	

Fixed Jib Length 18,3 m (60 ft)	Boom m (ft) Radius	24,4 (80)	36,6 (120)	42,7 (140)	54,9 (180)	61,0 (200)
	34,0 (110)	21,5 (48.3)				
40,0 (115)	17,2 (45.5)	16,1 —	15,5 —			
46,0 (125)	14,1 (40.7)	13,2 (38.0)	12,6 (36.6)	11,4 —	10,7 —	
52,0 (140)	11,2 (34.7)	11,0 (32.5)	10,5 (31.2)	9,4 (28.3)	8,8 (26.7)	
58,0 (160)	9,0 (28.0)	9,2 (26.7)	8,8 (25.6)	7,9 (23.1)	7,3 (21.7)	
64,0 (190)	— (20.0)	— (20.4)	7,4 (19.5)	6,6 (17.5)	6,1 (16.3)	
70,0 (230)						
76,0 (260)						
82,0 (280)						
88,0 (290)						

Luffing Jib Length 73,2 m (240 ft)	Boom m (ft) Radius	24,4 (80)	36,6 (120)	42,7 (140)
	34,0 (110)			
40,0 (115)				
46,0 (125)	12,9 —	11,8 —		
52,0 (140)	9,9 (32.0)	9,6 —	9,1 —	
58,0 (160)	7,7 (25.2)	8,0 (23.8)	7,5 (22.6)	
64,0 (190)	5,9 (17.1)	6,6 (17.7)	6,2 (16.7)	
70,0 (230)	4,6 (10.1)	5,5 (12.1)	5,0 (11.2)	
76,0 (260)	3,4 (6.4)	4,5 (9.0)	4,2 (8.3)	
82,0 (280)		3,7 —	3,3 (6.6)	
88,0 (290)				

Meets ANSI B30.5 Requirements - Capacities do not exceed 75% of static tipping load.
NOTICE: This capacity chart is for reference only and must not be used for lifting purposes.



Luffing jib load charts

Liftcrane Luffing Jib Capacities - Series 3 Luffing Jib No. 149 on Boom No. 82

99 609 kg (219,600 lb) Upperworks Counterweight 36 288 kg (80,000 lb) Carbody Counterweight
360° Rating kg (lb) x 1 000

65° Boom Angle

Luffing Jib Length 21,3 m (70 ft)	Boom m (ft) Radius	24,4 (80)	36,6 (120)	42,7 (140)	54,9 (180)	61,0 (200)
	25,9 (85)	— (67.3)				
30,0 (90)	25,3 (62.6)					
32,0 (100)	23,3 (54.8)	21,2 —				
36,0 (110)	— (48.3)	18,2 (44.2)	17,2 (41.8)			
40,0 (120)		— (39.4)	14,9 (37.3)	12,9 —		
44,0 (140)				11,2 (26.0)	10,2 (23.7)	
48,0 (160)					8,9 (19.2)	
52,0 (180)						
56,0 (200)						
60,0 (210)						

Luffing Jib Length 36,6 m (120 ft)	Boom m (ft) Radius	24,4 (80)	36,6 (120)	42,7 (140)	54,9 (180)	61,0 (200)
	25,9 (85)					
30,0 (90)						
32,0 (100)						
36,0 (110)		19,2 —				
40,0 (120)		16,7 (41.5)				
44,0 (140)		14,6 (33.7)	13,0 (30.0)	12,1 (28.0)		
48,0 (160)		12,9 (27.8)	11,4 (24.8)	10,7 (23.1)	— (19.1)	
52,0 (180)			10,1 —	9,4 (19.2)	7,8 (15.7)	6,8 (13.7)
56,0 (200)				8,3 —	6,8 (12.9)	6,0 (11.2)
60,0 (210)					6,0 —	5,2 (10.1)

Luffing Jib Length 51,8 m (170 ft)	Boom m (ft) Radius	24,4 (80)	36,6 (120)	42,7 (140)	54,9 (180)
	46,0 (145)	12,9 (30.2)			
50,0 (150)	11,3 (28.8)				
54,0 (160)	10,1 (26.1)	8,7 —	7,9 —		
58,0 (170)	9,0 (23.8)	7,7 (20.6)	7,0 (18.9)	54,9 (180)	
62,0 (190)	8,0 (20.0)	6,8 (17.1)	6,2 (15.6)	5,4 —	
68,0 (220)		5,7 (13.0)	5,1 (11.8)	4,7 (12.0)	
74,0 (250)				3,8 (8.8)	
80,0 (280)				3,0 (6.2)	
84,0 (290)					
88,0 (295)					

Luffing Jib Length 73,2 m (240 ft)	Boom m (ft) Radius	24,4 (80)	36,6 (120)
	46,0 (145)		
50,0 (150)			
54,0 (160)			
58,0 (170)		7,7 —	
62,0 (190)		6,8 (17.1)	36,6 (120)
68,0 (220)		5,6 (12.8)	4,4 (10.1)
74,0 (250)		4,5 (9.1)	3,5 (7.2)
80,0 (280)		3,3 (5.6)	2,8 (4.9)
84,0 (290)		2,7 —	2,3 (4.2)
88,0 (295)			1,9 —

Meets ANSI B30.5 Requirements - Capacities do not exceed 75% of static tipping load.
NOTICE: This capacity chart is for reference only and must not be used for lifting purposes.



Fixed jib on luffing jib range diagram

No. 138 Fixed Jib on No. 135 Luffing Jib on No. 82 or No. 22EL Main Boom

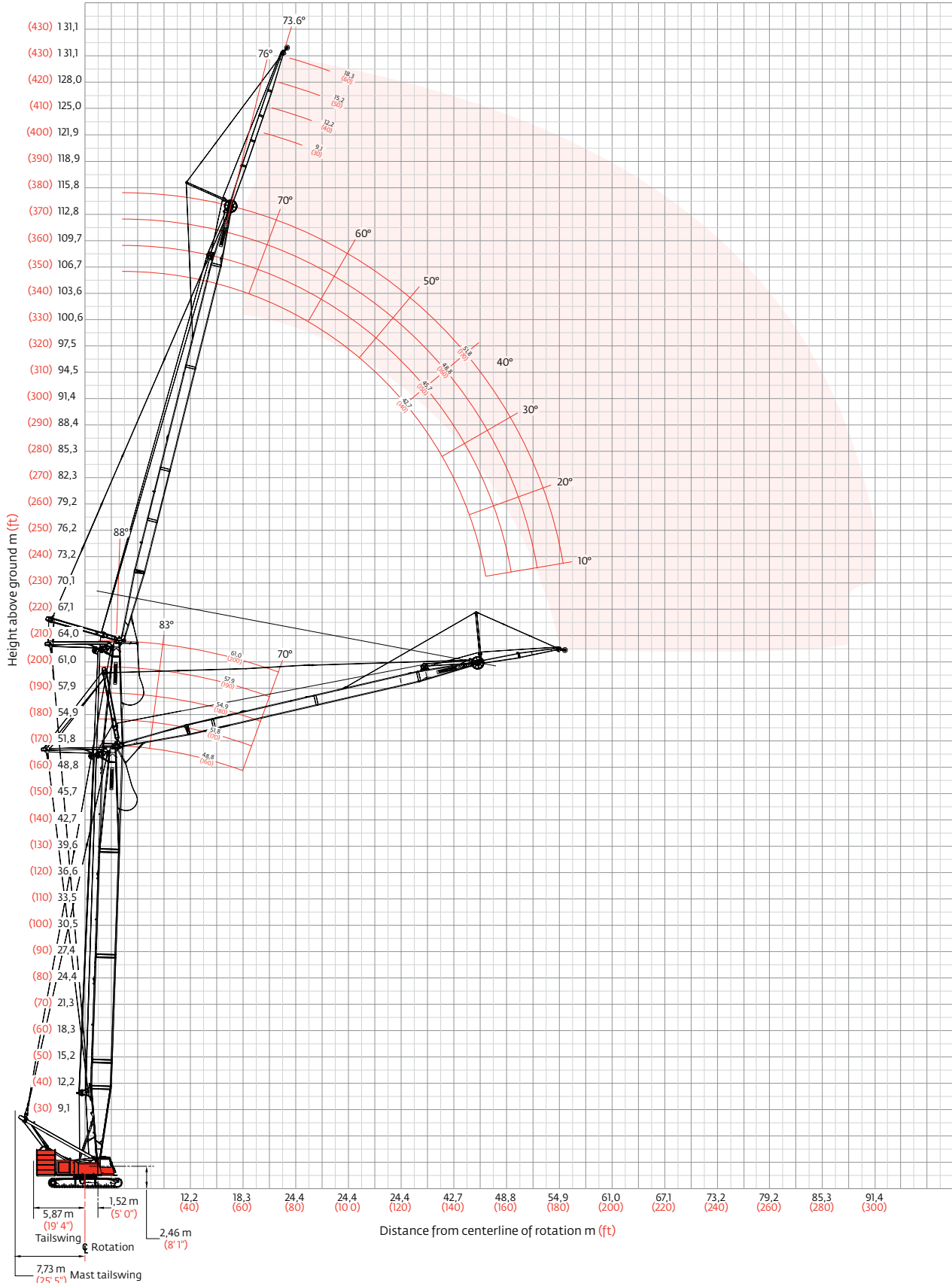



Fixed jib on luffing jib load charts

Liftcrane Fixed Jib on Luffing Capacities - Series 3

Fixed Jib No. 138 at 3 Degree Angle on Luffing Jib No. 135 on Boom No. 82 or No. 22EL

99 609 kg (219,600 lb) Upperworks Counterweight 36 288 kg (80,000 lb) Carbody Counterweight
360° Rating kg (lb) x1 000

88° Boom Angle

Luffing Jib m (ft)	42,7 (140)				45,7 (150)			48,8 (160)			51,8 (170)		
	48,8 (160)	54,9 (180)	61,0 (200)	39,6 (130)	45,7 (150)	51,8 (170)	57,9 (190)	64,0 (210)	70,1 (230)	76,2 (250)	82,3 (270)	88,4 (290)	
Boom m (ft) Radius													
18,3 (60)	12,4 (27.5)	12,3 (27.2)	12,1 (26.8)	12,2 (27.0)	12,0 (26.6)								
22,0 (70)	12,1 (26.9)	12,0 (26.6)	11,8 (26.3)	11,9 (26.4)	11,7 (26.1)	11,6 (25.7)	11,6 (25.8)	11,3 (25.2)	10,9 (24.4)	10,6 (23.7)	10,2 (22.8)	9,8 (21.7)	
28,0 (90)	11,5 (25.8)	11,5 (25.6)	11,4 (25.3)	11,3 (25.3)	11,3 (25.2)	11,1 (24.8)	11,0 (24.7)	10,9 (24.2)	10,5 (23.3)	10,0 (22.3)	9,7 (21.6)	9,3 (20.8)	
34,0 (110)	10,0 (22.3)	10,0 (22.4)	10,0 (22.4)	9,8 (22.0)	9,8 (22.0)	9,8 (22.0)	9,6 (21.6)	9,7 (21.6)	9,6 (21.5)	9,4 (21.1)	9,3 (20.7)	8,9 (19.9)	
40,0 (130)	8,8 (19.7)	8,9 (19.8)	8,9 (19.9)	8,7 (19.5)	8,7 (19.5)	8,8 (19.6)	8,6 (19.2)	8,6 (19.2)	8,5 (19.1)	8,4 (18.8)	8,4 (18.8)	8,0 (17.9)	
48,0 (150)	7,8 (17.8)	7,8 (17.9)	7,6 (17.9)	7,7 (17.6)	7,7 (17.6)	7,4 (17.4)	7,6 (17.4)	7,5 (17.4)	7,1 (16.7)	7,4 (17.1)	7,2 (16.8)	6,8 (15.9)	
52,0 (170)	7,4 (16.4)	7,2 (16.0)	6,8 (15.2)	7,2 (16.1)	7,0 (15.7)	6,7 (14.9)	7,1 (15.9)	6,8 (15.2)	6,5 (14.5)	6,9 (15.4)	6,6 (14.7)	6,2 (13.9)	
58,0 (190)				— (14.0)	6,0 (13.4)	5,7 (12.8)	6,2 (13.7)	5,9 (13.1)	5,6 (12.5)	6,0 (13.4)	5,7 (12.8)	5,5 (12.2)	
64,0 (220)										5,3 —	5,1 —	4,8 —	
72,0 (240)													

Luffing Jib m (ft)	42,7 (140)				45,7 (150)			48,8 (160)			51,8 (170)		
	48,8 (160)	54,9 (180)	61,0 (200)	39,6 (130)	45,7 (150)	51,8 (170)	57,9 (190)	64,0 (210)	70,1 (230)	76,2 (250)	82,3 (270)	88,4 (290)	
Boom m (ft) Radius													
18,3 (60)													
22,0 (70)	7,3 (16.4)	7,2 (16.2)	7,1 (15.9)	7,1 (15.8)	7,0 (15.6)	6,9 (15.3)	6,8 (15.2)						
28,0 (90)	6,7 (15.0)	6,7 (14.9)	6,6 (14.7)	6,5 (14.6)	6,5 (14.5)	6,4 (14.3)	6,3 (14.1)	6,2 (13.9)	6,1 (13.7)	6,0 (13.5)	5,9 (13.3)	5,8 (13.1)	
34,0 (110)	6,2 (13.8)	6,1 (13.7)	6,1 (13.6)	6,0 (13.5)	6,0 (13.4)	5,9 (13.2)	5,8 (13.0)	5,8 (12.9)	5,7 (12.8)	5,6 (12.6)	5,6 (12.5)	5,5 (12.2)	
40,0 (130)	5,7 (12.8)	5,7 (12.7)	5,7 (12.8)	5,6 (12.5)	5,6 (12.5)	5,5 (12.3)	5,5 (12.2)	5,4 (12.1)	5,4 (12.0)	5,3 (11.8)	5,2 (11.7)	5,1 (11.5)	
48,0 (150)	5,0 (11.6)	5,0 (11.6)	5,0 (11.6)	4,9 (11.4)	4,9 (11.5)	5,0 (11.5)	4,8 (11.3)	4,9 (11.3)	4,9 (11.3)	4,8 (11.1)	4,8 (11.0)	4,8 (10.9)	
52,0 (170)	4,7 (10.4)	4,7 (10.4)	4,7 (10.5)	4,6 (10.2)	4,6 (10.3)	4,6 (10.3)	4,5 (10.1)	4,6 (10.2)	4,6 (10.2)	4,5 (10.0)	4,5 (10.0)	4,5 (10.0)	
58,0 (190)	4,3 (9.5)	4,3 (9.5)	4,3 (9.5)	4,2 (9.3)	4,2 (9.4)	4,2 (9.4)	4,1 (9.2)	4,2 (9.3)	4,2 (9.3)	4,1 (9.1)	4,1 (9.1)	4,1 (9.1)	
64,0 (220)	3,9 —	3,9 —	3,9 —	3,9 (8.4)	3,9 (8.4)	3,9 (8.4)	3,8 (8.2)	3,8 (8.2)	3,9 (8.3)	3,8 (8.1)	3,8 (8.1)	3,8 (8.1)	
72,0 (240)										3,4 (7.6)	3,4 (7.6)	3,4 (7.6)	

Meets ANSI B30.5 Requirements - Capacities do not exceed 75% of static tipping load.

NOTICE: This capacity chart is for reference only and must not be used for lifting purposes.



Fixed jib on luffing jib load charts

Liftcrane Fixed Jib on Luffing Capacities - Series 3

Fixed Jib No. 138 at 3 Degree Angle on Luffing Jib No. 135 on Boom No. 82 or No. 22EL

99 609 kg (219,600 lb) Upperworks Counterweight 36 288 kg (80,000 lb) Carbody Counterweight
360° Rating kg (lb) x 1 000

83° Boom Angle

Luffing Jib m (ft)	42,7 (140)			45,7 (150)			48,8 (160)			51,8 (170)			
	48,8 (160)	54,9 (180)	61,0 (200)	48,8 (160)	54,9 (180)	61,0 (200)	48,8 (160)	54,9 (180)	61,0 (200)	48,8 (160)	54,9 (180)	61,0 (200)	
Boom m (ft)	26,0 (85)												
Radius	26,0 (85)												
Fixed Jib Length 9,1 m (30 ft)	28,0 (90)	12,1 (26.8)	12,0 (26.6)	11,8 (26.2)	11,8 (26.2)								
	30,0 (95)	12,0 (26.6)	11,9 (26.4)	11,7 (26.0)	11,7 (26.0)	11,6 (25.8)	11,4 (25.4)	11,0 (24.6)	10,7 (23.7)		9,8 (21.9)		
	34,0 (110)	11,2 (25.0)	11,4 (25.4)	11,5 (25.5)	10,9 (24.5)	11,1 (24.9)	11,2 (25.0)	10,8 (24.0)	10,4 (23.2)	10,1 (22.3)	9,6 (21.3)	9,3 (20.7)	9,0 (19.9)
	38,0 (120)	10,2 (23.3)	10,4 (23.7)	10,5 (24.1)	10,0 (22.9)	10,2 (23.2)	10,3 (23.5)	9,8 (22.4)	10,0 (22.7)	9,9 (22.1)	9,3 (20.9)	9,1 (20.3)	8,8 (19.6)
	44,0 (140)	9,0 (20.5)	9,1 (20.8)	9,3 (21.1)	8,9 (20.2)	9,0 (20.5)	9,1 (20.8)	8,7 (19.9)	8,9 (20.2)	9,0 (20.4)	8,6 (19.5)	8,7 (19.7)	8,6 (19.1)
	52,0 (170)	7,9 (17.5)	8,0 (17.8)	8,1 (18.0)	7,8 (17.3)	7,9 (17.5)	8,0 (17.7)	7,7 (17.1)	7,8 (17.3)	7,9 (17.5)	7,6 (16.8)	7,6 (17.0)	7,7 (17.2)
	60,0 (200)		7,2 (15.9)	7,3 (16.0)	7,0 (15.4)	7,1 (15.5)	7,2 (15.7)	6,9 (15.2)	7,0 (15.4)	7,1 (15.5)	6,8 (15.0)	6,9 (15.1)	6,9 (15.2)
	72,0 (230)										5,3 —	—	—
	80,0 (260)												
	Fixed Jib Length 18,3 m (60 ft)	26,0 (85)											
		28,0 (90)											
		30,0 (95)											
34,0 (110)		6,5 (14.6)	6,4 (14.4)	6,4 (14.3)	6,3 (14.0)	6,3 (14.0)	6,2 (13.9)	6,1 (13.6)	6,0 (13.4)	6,0 (13.3)	5,8 (13.0)	5,7 (12.8)	5,7 (12.6)
38,0 (120)		6,1 (13.9)	6,1 (13.9)	6,1 (13.8)	6,0 (13.5)	6,0 (13.5)	5,9 (13.4)	5,8 (13.1)	5,8 (13.0)	5,7 (12.9)	5,6 (12.6)	5,5 (12.5)	5,4 (12.3)
44,0 (140)		5,7 (12.9)	5,7 (12.9)	5,7 (12.9)	5,6 (12.6)	5,6 (12.6)	5,5 (12.5)	5,5 (12.3)	5,4 (12.2)	5,4 (12.1)	5,3 (11.8)	5,2 (11.7)	5,2 (11.6)
52,0 (170)		5,1 (11.3)	5,1 (11.5)	5,2 (11.7)	5,0 (11.2)	5,1 (11.3)	5,2 (11.5)	4,9 (11.0)	5,0 (11.2)	5,0 (11.2)	4,8 (10.8)	4,8 (10.8)	4,8 (10.8)
60,0 (200)		4,4 (9.7)	4,5 (9.9)	4,6 (10.0)	4,4 (9.6)	4,4 (9.7)	4,5 (9.9)	4,3 (9.5)	4,4 (9.6)	4,4 (9.7)	4,2 (9.3)	4,3 (9.4)	4,4 (9.6)
72,0 (230)			— (8.7)	— (8.8)	— (8.5)	3,8 (8.6)	3,8 (8.7)	3,7 (8.4)	3,7 (8.5)	3,7 (8.6)	3,6 (8.3)	3,7 (8.3)	3,7 (8.4)
80,0 (260)											3,4 (7.6)	— (7.6)	— (7.6)

Meets ANSI B30.5 Requirements - Capacities do not exceed 75% of static tipping load.
NOTICE: This capacity chart is for reference only and must not be used for lifting purposes.



Fixed jib on luffing jib load charts

Liftcrane Fixed Jib on Luffing Capacities - Series 3

Fixed Jib No. 138 at 3 Degree Angle on Luffing Jib No. 135 on Boom No. 82 or No. 22EL

99 609 kg (219,600 lb) Upperworks Counterweight 36 288 kg (80,000 lb) Carbody Counterweight
360° Rating kg (lb) x 1 000

70° Boom Angle

Luffing Jib m (ft)	42,7 (140)			45,7 (150)			48,8 (160)			51,8 (170)		
	48,8 (160)	54,9 (180)	61,0 (200)	48,8 (160)	54,9 (180)	61,0 (200)	48,8 (160)	54,9 (180)	61,0 (200)	48,8 (160)	54,9 (180)	61,0 (200)
Boom m (ft)	48,8 (160)	54,9 (180)	61,0 (200)	48,8 (160)	54,9 (180)	61,0 (200)	48,8 (160)	54,9 (180)	61,0 (200)	48,8 (160)	54,9 (180)	61,0 (200)
Radius												
48,0 (155)	10,3 (23.2)											
50,0 (160)	9,9 (22.5)			9,7 (21.9)								
52,0 (170)	9,5 (21.2)	9,8 (21.9)	9,3 (20.7)	9,4 (20.8)	9,6 (21.4)		8,8 (19.6)					
58,0 (190)	8,6 (19.0)	8,4 (18.7)	7,9 (17.6)	8,4 (18.7)	8,4 (18.6)	7,9 (17.5)	8,3 (18.4)	8,2 (18.2)	7,7 (17.1)	7,6 (16.8)	7,3 (16.2)	6,9 (15.4)
64,0 (210)	7,8 (17.3)	7,3 (16.1)	6,8 (15.1)	7,7 (17.1)	7,2 (16.0)	6,8 (15.0)	7,6 (16.9)	7,0 (15.6)	6,6 (14.6)	7,4 (16.4)	6,9 (15.3)	6,4 (14.3)
72,0 (230)	— (15.0)	6,0 (14.0)	5,6 (13.1)	6,4 (15.0)	6,0 (13.9)	5,6 (13.0)	6,3 (14.6)	5,8 (13.5)	5,4 (12.6)	6,2 (14.4)	5,7 (13.2)	5,3 (12.3)
76,0 (250)					5,4 (12.0)	5,1 (11.2)	5,7 (12.7)	5,3 (11.7)	4,9 (10.9)	5,6 (12.5)	5,2 (11.5)	4,8 (10.6)
84,0 (270)											— (9.9)	— (9.2)
88,0 (290)												
92,0 (300)												

Luffing Jib m (ft)	42,7 (140)			45,7 (150)			48,8 (160)			51,8 (170)		
	48,8 (160)	54,9 (180)	61,0 (200)	48,8 (160)	54,9 (180)	61,0 (200)	48,8 (160)	54,9 (180)	61,0 (200)	48,8 (160)	54,9 (180)	61,0 (200)
Boom m (ft)	48,8 (160)	54,9 (180)	61,0 (200)	48,8 (160)	54,9 (180)	61,0 (200)	48,8 (160)	54,9 (180)	61,0 (200)	48,8 (160)	54,9 (180)	61,0 (200)
Radius												
48,0 (155)												
50,0 (160)												
52,0 (170)												
58,0 (190)	5,3 (11.9)	5,3 (11.9)	5,3 (11.8)	5,2 (11.5)	5,1 (11.4)		4,9 (11.0)	4,9 (10.9)		4,7 (10.5)		
64,0 (210)	5,0 (11.1)	5,1 (11.4)	5,1 (11.4)	4,9 (10.9)	5,0 (11.1)	4,9 (11.0)	4,8 (10.7)	4,8 (10.6)	4,7 (10.5)	4,6 (10.2)	4,5 (10.1)	4,5 (10.0)
72,0 (230)	4,4 (10.1)	4,6 (10.4)	4,7 (10.9)	4,3 (9.9)	4,5 (10.3)	4,6 (10.7)	4,3 (9.8)	4,4 (10.1)	4,6 (10.3)	4,2 (9.6)	4,3 (9.9)	4,3 (9.8)
76,0 (250)	4,1 (9.2)	4,3 (9.5)	4,5 (9.9)	4,1 (9.1)	4,2 (9.4)	4,4 (9.7)	4,0 (9.0)	4,2 (9.3)	4,3 (9.6)	4,0 (8.8)	4,1 (9.1)	4,2 (9.4)
84,0 (270)		— (8.9)	— (9.1)	— (8.5)	3,8 (8.7)	3,9 (8.9)	3,7 (8.3)	3,8 (8.6)	3,9 (8.8)	3,6 (8.2)	3,7 (8.4)	3,8 (8.7)
88,0 (290)								3,6 (8.0)	3,7 (8.2)	3,5 (7.7)	3,5 (7.9)	3,6 (8.1)
92,0 (300)											— (7.7)	3,3 (7.6)

Meets ANSI B30.5 Requirements - Capacities do not exceed 75% of static tipping load.

NOTICE: This capacity chart is for reference only and must not be used for lifting purposes.



Fixed jib on luffing jib range diagram

No. 134 Fixed Jib on No. 149 Luffing Jib on No. 82 Main Boom

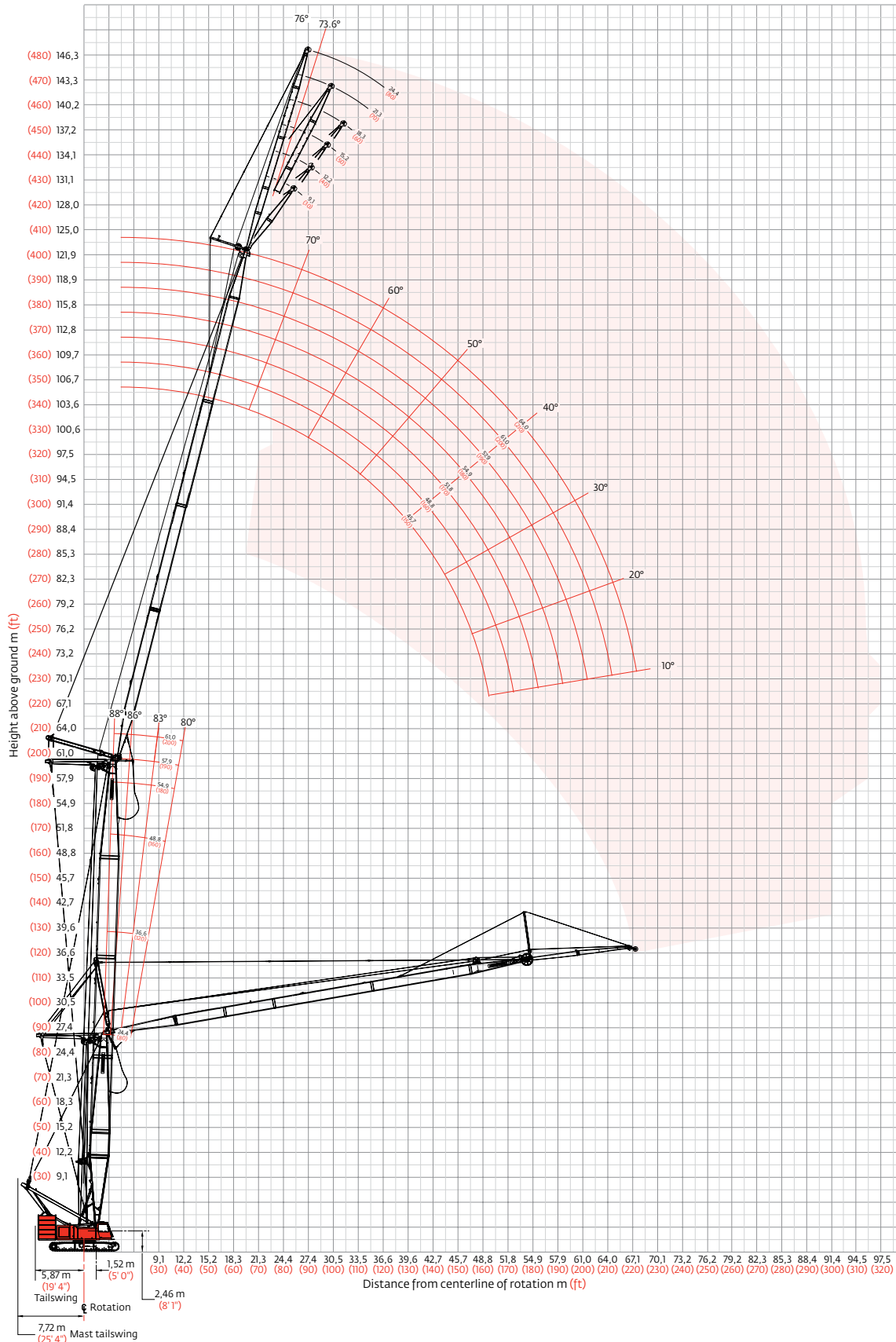



Fixed jib on luffing jib load charts

Liftcrane Fixed Jib on Luffing Capacities - Series 3

No. 134 Fixed Jib on No. 149 Luffing Jib on No. 82 Main Boom

99 609 kg (219,600 lb) Upperworks Counterweight 36 288 kg (80,000 lb) Carbody Counterweight
360° Rating kg (lb) x1 000

88° Boom Angle

Luffing Jib m (ft)	51,8 (170)			54,9 (180)			61,0 (200)			64,0 (210)			
	24,4 (80)	36,6 (120)	57,9 (190)	24,4 (80)	36,6 (120)	57,9 (190)	24,4 (80)	36,6 (120)	57,9 (190)	24,4 (80)	36,6 (120)	57,9 (190)	
Boom m (ft)	21,3 (70)	18,3 (60)	12,8 (42)	19,5 (64)	17,0 (56)								
Radius	22,0 (72)	28,0 (92)	34,0 (112)	40,0 (132)	48,0 (156)	52,0 (172)	58,0 (192)	64,0 (212)	72,0 (236)	76,0 (252)			
Fixed Jib Length 9,1 m (30 ft)	21,3 (70)	18,3 (60)	12,8 (42)	19,5 (64)	17,0 (56)								
	28,0 (90)	20,4 (67)	17,6 (58)	12,0 (39)	19,0 (62)	16,3 (53)	11,3 (37)	15,8 (47)	13,8 (42)	9,9 (30)	14,4 (44)	12,7 (38)	9,3 (28)
	34,0 (110)	17,4 (57)	14,5 (46)	10,1 (33)	16,6 (54)	14,1 (43)	9,8 (29)	15,2 (48)	13,2 (40)	9,1 (28)	13,8 (41)	12,2 (37)	8,7 (26)
	40,0 (130)	14,2 (46)	11,6 (37)	8,2 (25)	14,0 (43)	11,5 (36)	8,0 (24)	13,4 (40)	11,0 (34)	7,5 (23)	12,9 (39)	10,6 (32)	7,3 (22)
	48,0 (150)	10,4 (33)	8,6 (26)	6,2 (19)	10,2 (33)	8,6 (26)	6,0 (18)	9,8 (28)	8,5 (24)	5,8 (17)	9,6 (29)	8,4 (25)	5,7 (17)
	52,0 (170)	9,0 (27)	7,5 (23)	5,4 (16)	8,7 (25)	7,5 (22)	5,3 (16)	8,3 (24)	7,5 (22)	5,1 (15)	8,1 (23)	7,4 (21)	5,0 (15)
	58,0 (190)	7,2 (22)	6,1 (19)	4,5 (13)	7,0 (20)	6,2 (18)	4,4 (13)	6,6 (19)	6,2 (18)	4,2 (12)	6,4 (18)	6,2 (18)	4,2 (12)
	64,0 (220)	4,6 (14)	5,4 (16)	3,9 (11)	5,6 (16)	5,3 (15)	3,8 (11)	5,2 (15)	5,2 (15)	3,6 (11)	4,9 (14)	5,2 (15)	3,5 (10)
	72,0 (240)							3,2 (9)	4,3 (13)	3,0 (9)	3,4 (10)	4,3 (13)	2,8 (8)
	76,0 (250)										1,9 (6)	3,2 (10)	2,2 (7)
	Fixed Jib Length 18,3 m (60 ft)	24,0 (85)	—	—	—	—	—	—	—	—	—	—	—
		28,0 (90)	10,6 (33)	10,2 (32)	8,6 (26)	10,4 (32)	9,9 (30)	8,2 (25)	9,7 (29)	9,1 (28)	7,3 (22)	9,3 (28)	8,6 (25)
34,0 (110)		10,0 (30)	9,8 (29)	8,3 (25)	9,8 (29)	9,5 (28)	7,9 (23)	9,4 (28)	8,9 (26)	7,1 (21)	9,0 (26)	8,4 (24)	6,7 (20)
40,0 (130)		9,5 (28)	9,3 (28)	7,4 (22)	9,4 (28)	9,1 (26)	7,2 (21)	9,0 (26)	8,6 (24)	6,7 (20)	8,7 (25)	8,2 (23)	6,4 (19)
48,0 (150)		8,3 (25)	8,0 (23)	5,7 (16)	7,9 (23)	7,8 (22)	5,6 (16)	8,0 (23)	7,6 (22)	5,3 (15)	7,6 (22)	7,4 (21)	5,1 (15)
52,0 (170)		7,5 (22)	6,9 (20)	5,0 (14)	7,2 (21)	6,9 (20)	4,9 (14)	7,3 (21)	6,8 (19)	4,7 (13)	7,0 (19)	6,6 (19)	4,5 (13)
58,0 (190)		6,6 (19)	5,6 (16)	4,0 (11)	6,3 (19)	5,7 (16)	4,0 (11)	6,4 (19)	5,6 (16)	3,8 (11)	6,1 (17)	5,6 (16)	3,8 (11)
64,0 (220)		5,8 (16)	4,6 (13)	3,3 (9)	5,6 (16)	4,7 (13)	3,3 (9)	5,5 (15)	4,7 (13)	3,2 (9)	5,3 (15)	4,7 (13)	3,1 (9)
72,0 (240)		4,3 (13)	3,7 (11)	2,6 (8)	4,3 (12)	3,7 (10)	2,6 (7)	3,9 (11)	3,7 (10)	2,5 (7)	3,7 (10)	3,7 (10)	2,5 (7)
84,0 (280)											2,7 (8)		

Meets ANSI B30.5 Requirements - Capacities do not exceed 75% of static tipping load.
NOTICE: This capacity chart is for reference only and must not be used for lifting purposes.



Fixed jib on luffing jib load charts

Liftcrane Fixed Jib on Luffing Capacities - Series 3

No. 134 Fixed Jib on No. 149 Luffing Jib on No. 82 Main Boom

99 609 kg (219,600 lb) Upperworks Counterweight 36 288 kg (80,000 lb) Carbody Counterweight
360° Rating kg (lb) x1 000

83° Boom Angle

Luffing Jib m (ft)	51,8 (170)			54,9 (180)			61,0 (200)			64,0 (210)		
	24,4 (80)	36,6 (120)	57,9 (190)	24,4 (80)	36,6 (120)	57,9 (190)	24,4 (80)	36,6 (120)	57,9 (190)	24,4 (80)	36,6 (120)	57,9 (190)
Boom m (ft)												
Radius												
28,0 (90)	21,8 (49.0)											
30,0 (95)	20,7 (47.0)	20,9 (46.3)		20,0 (45.5)								
34,0 (110)	18,6 (41.7)	19,1 (42.8)	14,4 (31.9)	18,1 (40.5)	18,6 (41.5)	13,4 (29.7)	17,4 (38.8)	15,8 (35.0)		16,0 (35.6)	14,5 (32.0)	
38,0 (120)	17,0 (38.9)	17,2 (39.5)	13,6 (31.1)	16,2 (37.2)	16,5 (38.0)	12,9 (29.2)	16,0 (36.4)	15,7 (34.8)	11,4 (25.4)	14,9 (34.0)	14,3 (31.7)	10,6 (23.5)
44,0 (140)	13,3 (31.0)	14,6 (33.6)	11,4 (26.2)	13,0 (30.4)	14,0 (32.1)	11,0 (25.4)	12,6 (29.5)	13,5 (31.0)	10,3 (23.6)	12,4 (29.1)	13,2 (30.1)	9,9 (22.5)
52,0 (170)	9,7 (21.7)	11,6 (25.9)	8,7 (19.4)	9,5 (21.2)	11,4 (25.4)	8,6 (19.2)	9,1 (20.3)	11,0 (24.5)	8,3 (18.5)	8,9 (19.8)	10,7 (23.9)	8,1 (18.0)
60,0 (200)	7,2 (15.5)	8,6 (18.4)	6,6 (14.3)	7,0 (15.0)	8,5 (18.3)	6,6 (14.3)	6,6 (14.1)	8,2 (17.5)	6,5 (14.1)	6,4 (13.6)	7,9 (17.0)	6,4 (13.9)
72,0 (230)			— (11.2)		— (13.1)	4,7 (11.0)	4,0 (9.7)	5,2 (12.4)	4,4 (10.6)	3,8 (9.2)	5,0 (12.0)	4,2 (10.1)
76,0 (250)								4,4 (9.6)	3,8 (8.3)	3,1 (6.9)	4,2 (9.4)	3,5 (7.8)
80,0 (260)									— (7.3)		— (8.0)	2,9 (6.8)

Fixed Jib Length 9,1 m (30 ft)

Luffing Jib m (ft)	51,8 (170)			54,9 (180)			61,0 (200)			64,0 (210)		
	24,4 (80)	36,6 (120)	57,9 (190)	24,4 (80)	36,6 (120)	57,9 (190)	24,4 (80)	36,6 (120)	57,9 (190)	24,4 (80)	36,6 (120)	57,9 (190)
Boom m (ft)												
Radius												
32,0 (105)	11,8 (26.2)											
38,0 (120)	11,3 (25.2)	11,1 (24.7)	9,8 (21.8)	11,1 (24.8)	10,8 (24.1)	9,3 (20.7)	10,5 (23.6)	10,1 (22.4)		— (22.7)		
44,0 (140)	9,9 (22.7)	10,2 (23.4)	9,6 (21.4)	9,5 (21.8)	9,8 (22.4)	9,2 (20.4)	9,5 (21.8)	9,7 (22.0)	8,2 (18.2)	9,0 (20.7)	9,3 (21.0)	7,7 (17.1)
52,0 (170)	8,1 (18.0)	8,2 (18.3)	8,1 (18.0)	7,8 (17.3)	7,9 (17.6)	7,9 (17.6)	7,9 (17.5)	8,0 (17.8)	7,4 (16.6)	7,4 (16.6)	7,6 (16.9)	7,2 (16.0)
60,0 (200)	6,8 (14.8)	6,8 (14.8)	6,2 (13.4)	6,5 (14.2)	6,6 (14.3)	6,2 (13.4)	6,6 (14.4)	6,7 (14.5)	6,0 (13.1)	6,3 (13.6)	6,4 (13.8)	5,9 (12.8)
72,0 (230)	5,0 (11.8)	5,4 (12.3)	4,2 (9.9)	4,7 (11.3)	5,1 (11.8)	4,2 (10.0)	4,3 (10.4)	5,3 (12.2)	4,2 (10.0)	4,1 (9.9)	5,0 (11.5)	4,2 (9.9)
80,0 (260)			— (7.6)	— (5.6)	4,1 (10.0)	3,2 (7.6)	3,0 (6.9)	4,1 (9.3)	3,3 (7.6)	2,8 (6.5)	3,8 (8.8)	3,1 (7.2)
82,0 (275)							— (5.5)	3,8 (7.7)	3,1 (6.3)	2,5 (5.0)	3,5 (7.3)	2,8 (5.8)
86,0 (285)								2,9 (5.2)	2,5 (5.5)	2,0 (4.2)	2,9 (6.3)	2,3 (5.0)
88,0 (290)									2,3 (5.0)		2,6 (5.8)	2,1 (4.6)

Fixed Jib Length 18,3 m (60 ft)

Meets ANSI B30.5 Requirements - Capacities do not exceed 75% of static tipping load.
NOTICE: This capacity chart is for reference only and must not be used for lifting purposes.



Fixed jib on luffing jib load charts

Liftcrane Fixed Jib on Luffing Capacities - Series 3

Fixed Jib No. 138 at 3 Degree Angle on Luffing Jib No. 135 on Boom No. 82 or No. 22EL

99 609 kg (219,600 lb) Upperworks Counterweight 36 288 kg (80,000 lb) Carbody Counterweight
360° Rating kg (lb) x1 000

80° Boom Angle

Luffing Jib m (ft)	51,8 (170)			54,9 (180)			61,0 (200)			64,0 (210)		
	24,4 (80)	36,6 (120)	57,9 (190)	24,4 (80)	36,6 (120)	57,9 (190)	24,4 (80)	36,6 (120)	57,9 (190)	24,4 (80)	36,6 (120)	57,9 (190)
Radius												
32,0 (105)	20,3 (44.9)											
38,0 (130)	17,6 (37.1)	18,1 (37.7)	— (31.4)	16,9 (35.8)	17,7 (37.3)	— (29.0)	16,5 (35.3)	— (33.8)		15,4 (32.9)	— (30.7)	
48,0 (155)	11,9 (27.1)	12,9 (29.3)	11,6 (26.3)	11,6 (26.6)	12,7 (28.8)	11,2 (25.5)	11,2 (25.7)	12,4 (28.1)	10,8 (24.4)	11,0 (25.2)	12,2 (27.7)	10,2 (22.7)
50,0 (160)	11,0 (25.6)	12,2 (28.0)	10,8 (25.0)	10,8 (25.0)	11,9 (27.5)	10,5 (24.2)	10,4 (24.1)	11,6 (26.7)	10,0 (23.1)	10,2 (23.7)	11,4 (26.3)	9,8 (22.5)
52,0 (170)	10,2 (22.7)	11,5 (25.5)	10,1 (22.5)	9,9 (22.2)	11,2 (25.0)	9,8 (21.8)	9,5 (21.3)	10,9 (24.3)	9,3 (20.7)	9,4 (20.9)	10,7 (23.9)	9,0 (20.1)
58,0 (190)	8,1 (18.1)	9,6 (21.4)	8,3 (18.4)	7,9 (17.6)	9,4 (20.9)	8,0 (17.7)	7,5 (16.7)	9,1 (20.2)	7,5 (16.7)	7,3 (16.3)	8,9 (19.8)	7,2 (16.1)
64,0 (210)	6,5 (14.5)	8,2 (18.1)	6,8 (15.1)	6,3 (14.0)	7,9 (17.6)	6,5 (14.4)	5,9 (13.1)	7,5 (16.7)	6,0 (13.4)	5,7 (12.6)	7,3 (16.2)	5,8 (12.9)
72,0 (230)		— (13.6)	5,2 (12.4)	— (11.0)	5,9 (14.2)	4,9 (11.7)	4,2 (10.2)	5,6 (13.3)	4,5 (10.7)	4,0 (9.7)	5,4 (12.9)	4,2 (10.2)
76,0 (250)						4,2 (9.4)	3,5 (7.8)	4,8 (10.6)	3,8 (8.4)	3,3 (7.3)	4,6 (10.1)	3,6 (7.9)
84,0 (270)									— (6.4)		— (6.9)	2,4 (6.0)

Fixed Jib Length 9,1 m (30 ft)

Luffing Jib m (ft)	51,8 (170)			54,9 (180)			61,0 (200)			64,0 (210)	
	24,4 (80)	36,6 (120)	57,9 (190)	24,4 (80)	36,6 (120)	57,9 (190)	24,4 (80)	36,6 (120)	57,9 (190)	24,4 (80)	36,6 (120)
Radius											
38,0 (125)	11,2 (24.8)										
48,0 (130)	9,3 (24.5)	9,7 (24.1)	9,1 (—)	8,9 (24.1)	9,3 (23.5)	9,1 (—)	8,9 (22.8)	9,4 (—)	8,0 (—)	8,5 (—)	8,9 (—)
50,0 (160)	8,9 (20.2)	9,2 (21.1)	9,0 (21.0)	8,5 (19.4)	8,8 (20.2)	9,0 (20.1)	8,5 (19.5)	8,9 (20.3)	8,0 (17.8)	8,1 (18.5)	8,4 (19.3)
52,0 (170)	8,4 (18.8)	8,8 (19.5)	9,0 (20.7)	8,1 (18.0)	8,4 (18.7)	9,0 (20.0)	8,2 (18.2)	8,5 (18.9)	8,0 (17.8)	7,7 (17.2)	8,0 (17.9)
58,0 (190)	7,4 (16.4)	7,6 (16.9)	7,7 (17.9)	7,1 (15.7)	7,3 (16.2)	7,7 (17.2)	7,1 (15.9)	7,4 (16.4)	7,7 (17.1)	6,8 (15.1)	7,0 (15.6)
64,0 (210)	6,5 (14.4)	6,7 (14.8)	6,7 (15.4)	6,2 (13.8)	6,4 (14.2)	6,7 (14.8)	6,3 (14.0)	6,5 (14.4)	6,2 (13.8)	6,0 (13.3)	6,2 (13.7)
72,0 (230)	5,2 (12.4)	5,7 (13.3)	5,1 (12.8)	5,0 (11.8)	5,4 (12.5)	5,1 (12.1)	4,5 (10.9)	5,6 (12.8)	4,6 (11.1)	4,3 (10.5)	5,3 (12.1)
76,0 (250)	4,5 (9.9)	— (11.6)	4,4 (10.5)	4,2 (9.3)	5,0 (11.2)	4,4 (9.8)	3,8 (8.4)	5,1 (11.3)	4,0 (8.8)	3,6 (8.0)	4,9 (10.8)
84,0 (270)			3,2 (8.4)		— (9.3)	3,2 (7.8)	2,6 (6.3)	3,7 (8.9)	2,8 (6.8)	2,4 (5.9)	3,5 (8.4)
90,0 (300)									— (4.3)		2,6 (5.0)

Fixed Jib Length 18,3 m (60 ft)

Meets ANSI B30.5 Requirements - Capacities do not exceed 75% of static tipping load.

NOTICE: This capacity chart is for reference only and must not be used for lifting purposes.



Manitowoc Crane Care

Crane Care is Manitowoc's comprehensive service and support program. It includes classroom and on-site training, prompt parts availability, expert field service, technical support and documentation – for every one of the more than 7,000 Manitowoc cranes currently in use throughout the world.

That's commitment you won't find anywhere else.

That's Crane Care.

Service training

Manitowoc specialists work with you in our training centers and in the field to make sure you know how to get maximum performance, reliability and life from your cranes.

Manitowoc Cranes Technical Training Centers provide valuable multi-level training, which is available for all models and attachments, in the following format:

- **Intro to Canbus and Canbus 1, 2, 3**
- **Intro to EPIC and EPIC 1, 2, 3**
- **Small Crawler 1**
- **Canbus 1 and 2 assembly, operation and maintenance**
- **EPIC 1 and 2 assembly, operation and maintenance**

Refer to www.manitowoc.com for course descriptions.

Parts availability

Genuine Manitowoc replacement parts are accessible through your distributor 24 hours a day, 7 days a week, 365 days a year.

Service interval kits

200 hour kit

1,000 hour kit

2,000 hour kit

Hydraulic test kit

U.S. standard tools kit

Field service

Factory-trained service experts are always ready to help maintain your crane's peak performance.

For a worldwide listing of dealer locations, please consult our website at: www.manitowoc.com

Technical support

Manitowoc's dealer network and factory personnel are available 24 hours a day, 7 days a week, 365 days a year to answer your technical questions and more,

with the help of computerized programs that simplify crane selection, lift planning, and ground-bearing calculations.

For a worldwide listing of dealer locations, please consult our website at: www.manitowoc.com

Technical documentation

Manitowoc has the industry's most extensive documentation; available in major languages and formats that include print, videotape, and DVD/CD.

Additional copies available through your Authorized Manitowoc Distributor.

- Crane Operator's Manual
- Crane Parts Manual
- Crane Capacity Manual
- Crane Vendor Manual
- Crane Service Manual
- Luffing Jib Operator's/Parts Manual
- Capacity Chart Manual - Attachments

CD rom versions of the Operator's and Parts Manuals are shipped with each crane. Also available are the following CDs:

- Crane Care Owner CD –
- Ground Bearing Pressure Estimator CD
- Crane Selection and Planning Software (CompuCRANE®)
- EPIC® Crane Library CD consisting of capacity charts, range diagrams, wire rope specifications, travel specifications, crane weights, counterweight arrangements, luffing jib raising procedures, operating range diagrams, drum and lagging charts, boom rigging drawings, jib rigging drawings, outline dimensions and wind condition charts.

Available from your Authorized Manitowoc Cranes Distributor, these videos are available in NTSC, PAL, SECAM, and DVD formats.

- Your Capacity Chart Video
- Respect the Limits Video
- Crane Safety Video
- Boom Inspection/Repair Video

Crane Care Package

Manitowoc has assembled all of the available literature, CD's and videos listed above plus several Manitowoc premiums into one complete Crane Care Package.



Notes



Regional headquarters

Manitowoc - Americas

Manitowoc, Wisconsin, USA

Tel: +1 920 684 6621

Fax: +1 920 683 6277

Shady Grove, Pennsylvania, USA

Tel: +1 717 597 8121

Fax: +1 717 597 4062

Manitowoc - Europe, Middle East, Africa

Ecully, France

Tel: +33 (0)4 72 18 20 20

Fax: +33 (0)4 72 18 20 00

Manitowoc - Asia - Pacific

Shanghai, China

Tel: +86 21 6457 0066

Fax: +86 21 6457 4955

Regional offices

Americas

Brazil

Alphaville

Mexico

Monterrey

Chile

Santiago

Portugal

Baltar

Russia

Moscow

U.A.E.

Dubai

U.K.

Gawcott

Europe, Middle East,

Africa

Czech Republic

Netvorice

France

Baudemont

Cergy

Decines

Germany

Langenfeld

Hungary

Budapest

Italy

Parabiago

Netherlands

Breda

Poland

Warsaw

Asia - Pacific

Australia

Brisbane

Melbourne

Sydney

China

Beijing

Xi'an

India

Hyderabad

Pune

Korea

Seoul

Philippines

Makati City

Singapore

Factories

Brazil

Alphaville

China

TaiAn

Zhangjiagang

France

Charlieu

La Clayette

Moulins

Germany

Wilhelmshaven

India

Pune

Italy

Niella Tanaro

Portugal

Baltar

Fânzeres

Slovakia

Saris

USA

Manitowoc

Port Washington

Shady Grove

This document is non-contractual. Constant improvement and engineering progress make it necessary that we reserve the right to make specification, equipment, and price changes without notice. Illustrations shown may include optional equipment and accessories and may not include all standard equipment.