

60 ton All-Terrain Crane Demag AC 155

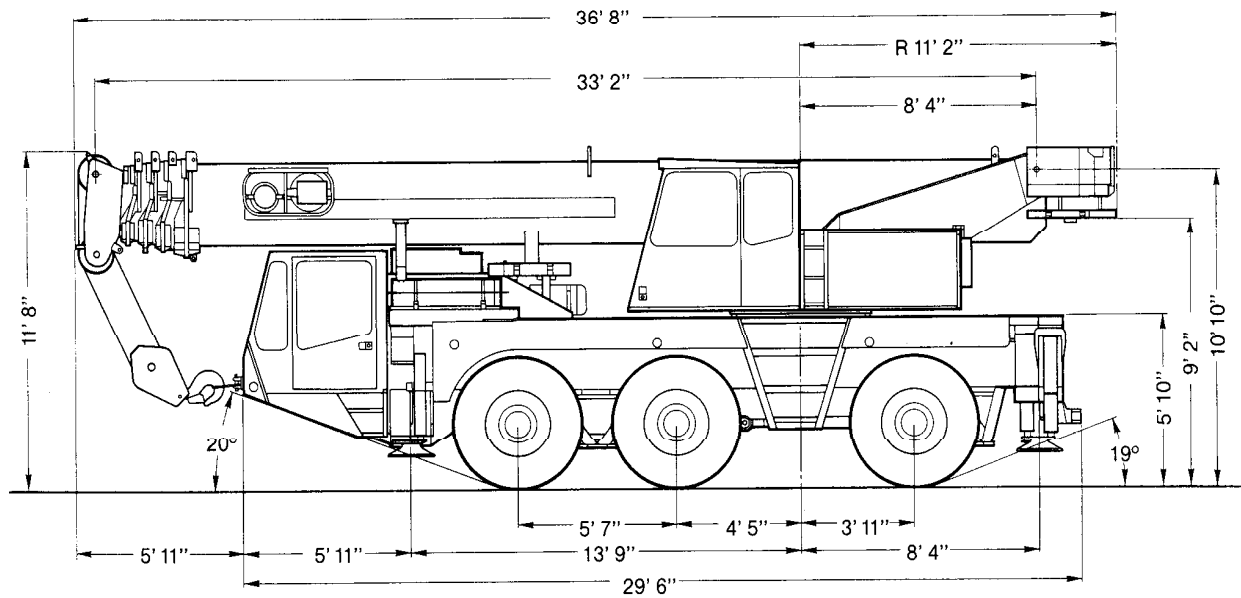

Dimensions



Dimensions

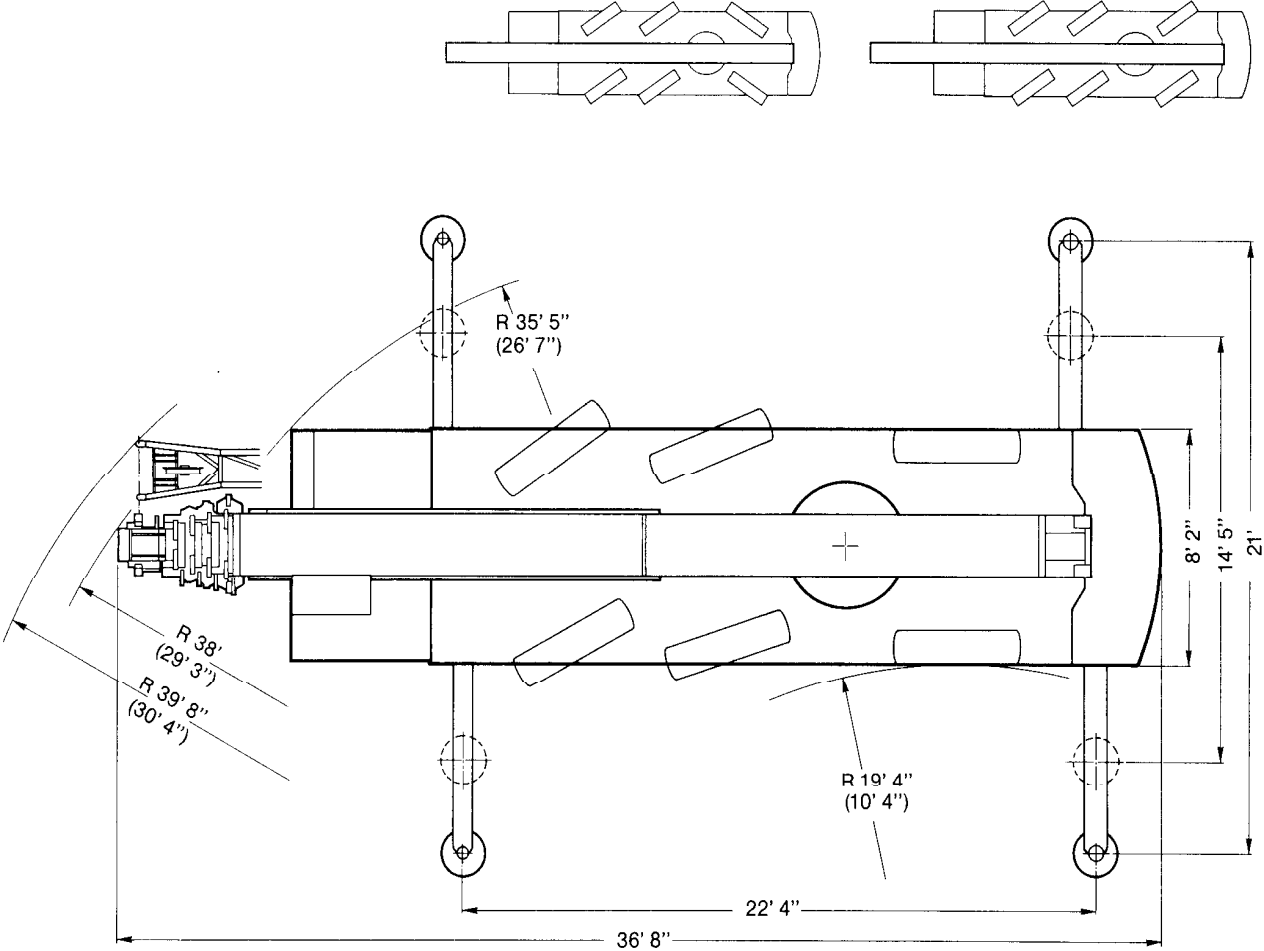

() with independent rear axle steering

Specifications

Axle loads

Crane with main boom, 58.4 ft main boom extension, hook block type 16, 13,250 lb counterweight	
Axles	3 x 26,400 lb
Total	79,200 lb

Working speeds (infinitely variable)

Units	Normal speed	High speed	Max. permissible line pull ¹⁾	Length of hoist rope
Hoist I	174 ft/min	361 ft/min	9,500 lb	590 ft
Hoist II	174 ft/min	361 ft/min	9,500 lb	590 ft
Slewing				max. 2 rpm
Telescoping speed	33.1 - 131.2 ft: 90 s			
Boom elevation	-1,5° - +81,5°: 45 s			

Carrier performance

Travel speed	0..7.5 mph
Reverse	0..4.4 mph
Forward	max. 62%
Gradeability in travel order	1'1"
Ground clearance	

Hook block/Single line hook

Type	Possible load ²⁾	Number of sheaves	Number of lines	Weight	"D"
63*)	110,000 lb	6	12	1,056 lb	6' 7"
32	66,220 lb	3	7	814 lb	5' 11"
16	28,380 lb	1	3	550 lb	5' 11"
5	9,460 lb	Single line hook	1	286 lb	5' 7"

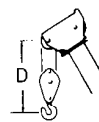

*) heavy-lift attachment is required, without heavy-lift attachment: capacity 75,680 lb (8 lines)

¹⁾ varies depending on national regulations

²⁾ varies depending on line pull permissible under different national regulations

Notes to lifting capacity

Lifting capacities do not exceed 85% of tipping load.

Weight of hook blocks and slings is part of the load, and is to be deducted from the capacity ratings.

Crane operation is permissible up to a

wind speed of 32 ft/s



Consult operation manual for further details on wind speed.

All capacities above the parting line are based on structural competence. Capacities below the parting line are based on machine stability.

Crane operation subject to computer charts, only!

For crane operation consult operation manual first!

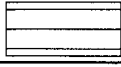

Lifting capacities main boom in 1,000 lb

19,850 lb   **22' 4" x 21' 360°** **85%**

Radius ft	Main boom											0° over rear	
	33.1 ft	52.8 ft	52.8 ft	72.5 ft	72.5 ft	91.9 ft	91.9 ft	106.6 ft	111.5 ft	121.4 ft	131.2 ft	33.1 ft	52.8 ft
	1,000 lb											1,000 lb	
9	120.0*	-	-	-	-	-	-	-	-	-	-	-	-
10	106.4	-	-	-	-	-	-	-	-	-	-	27.2	-
11	100.5	67.9	38.8	-	-	-	-	-	-	-	-	25.2	26.1
13	90.9	67.9	50.0	50.0	50.0	-	-	-	-	-	-	21.0	22.9
15	81.8	67.9	38.8	38.8	36.3	31.5	26.6	-	-	-	-	19.0	20.2
16	78.1	67.9	38.8	38.8	36.3	31.5	26.6	16.9	22.9	-	-	17.7	19.0
19	66.2	62.1	38.8	38.4	36.3	31.5	26.6	16.9	22.9	19.4	-	14.9	16.0
23	50.5	47.9	38.8	37.9	33.9	29.9	25.1	16.9	22.4	19.1	15.8	11.8	12.9
26	-	38.6	38.8	37.3	31.7	28.5	23.9	16.9	21.8	18.7	15.8	-	11.1
29	-	31.8	35.2	34.6	29.4	26.9	22.5	16.9	21.2	18.3	15.5	-	9.7
33	-	24.9	28.8	28.6	26.9	25.0	20.8	16.9	20.2	17.6	15.1	-	7.8
39	-	18.6	22.2	21.8	22.9	21.8	18.6	15.5	19.0	16.5	14.7	-	5.8
46	-	-	-	16.4	17.6	16.7	16.2	13.6	16.7	15.4	13.8	-	-
52	-	-	-	13.2	14.5	13.4	14.6	12.0	13.4	13.8	12.6	-	-
59	-	-	-	10.6	11.9	10.6	12.1	10.1	10.8	10.8	11.2	-	-
65	-	-	-	-	-	8.9	10.3	9.1	9.2	9.2	9.2	-	-
72	-	-	-	-	-	7.1	8.8	7.9	7.3	7.3	7.3	-	-
79	-	-	-	-	-	5.6	7.2	7.0	5.6	6.1	6.1	-	-
85	-	-	-	-	-	-	-	6.6	4.8	4.9	4.9	-	-
92	-	-	-	-	-	-	-	5.4	3.9	3.9	3.9	-	-
98	-	-	-	-	-	-	-	-	2.9	3.1	3.1	-	-
105	-	-	-	-	-	-	-	-	-	2.2	2.4	-	-
111	-	-	-	-	-	-	-	-	-	-	1.8	-	-
Boom extension sequence %													
Tele 1	0	80	0	40	0	60	0	0	80	90	100	0	0
Tele 2	0	0	27	40	54	60	80	100	80	90	100	0	27
Tele 3	0	0	27	40	54	60	80	100	80	90	100	0	27
Tele 4	0	0	27	40	54	60	80	100	80	90	100	0	27

*) over rear

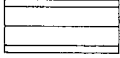
Lifting capacities main boom in 1,000 lb

19,850 lb   **22'4" x 14'5" 360°** **85%**

Radius ft	Main boom										
	33.1 ft	52.8 ft	52.8 ft	72.5 ft	72.5 ft	91.9 ft	91.9 ft	106.6 ft	111.5 ft	121.4 ft	131.2 ft
10	93.6	-	-	-	-	-	-	-	-	-	-
11	88.0	67.9	38.8	-	-	-	-	-	-	-	-
13	77.9	67.9	38.8	38.8	36.3	-	-	-	-	-	-
15	66.2	63.4	38.8	38.8	36.3	31.5	26.6	-	-	-	-
16	58.1	55.6	38.8	38.8	36.3	31.5	26.6	16.9	22.9	-	-
19	42.1	39.9	38.8	38.4	36.3	31.5	26.6	16.9	22.9	19.4	-
23	29.2	27.2	31.2	31.0	32.3	29.9	25.1	16.9	22.4	19.1	15.8
26	-	21.8	25.3	25.1	26.4	25.2	23.9	16.9	21.8	18.7	15.8
29	-	17.8	21.3	20.8	22.3	21.0	22.3	16.9	20.9	18.3	15.5
33	-	13.9	17.0	16.8	18.1	16.8	18.5	16.8	17.0	17.2	15.1
39	-	9.9	12.8	12.6	13.5	12.6	14.1	14.2	12.8	13.0	12.9
46	-	-	-	9.2	10.3	9.4	10.5	10.7	9.4	9.6	9.6
52	-	-	-	7.2	8.3	7.4	8.5	8.9	7.4	7.6	7.6
59	-	-	-	5.5	6.6	5.5	6.8	7.0	5.7	5.7	5.7
65	-	-	-	-	-	4.5	5.6	5.8	4.7	4.7	4.7
72	-	-	-	-	-	3.1	4.6	4.8	3.3	3.5	3.5
79	-	-	-	-	-	2.1	3.9	3.9	2.3	2.6	2.6
85	-	-	-	-	-	-	-	3.3	1.7	1.8	1.8
92	-	-	-	-	-	-	-	2.6	-	-	-

Boom extension sequence %

Tele 1	0	80	0	40	0	60	0	0	80	90	100
Tele 2	0	0	27	40	54	60	80	100	80	90	100
Tele 3	0	0	27	40	54	60	80	100	80	90	100
Tele 4	0	0	27	40	54	60	80	100	80	90	100

Lifting capacities main boom in 1,000 lb

13,250 lb

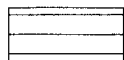

22' 4" x 21' 360°

85%



Radius ft	Main boom											0° over rear	
	33.1 ft	52.8 ft	52.8 ft	72.5 ft	72.5 ft	91.9 ft	91.9 ft	106.6 ft	111.5 ft	121.4 ft	131.2 ft	33.1 ft	52.8 ft
	1,000 lb											1,000 lb	
9	120.0*	-	-	-	-	-	-	-	-	-	-	-	-
10	105.8	-	-	-	-	-	-	-	-	-	-	26.1	-
11	100.1	67.9	38.8	-	-	-	-	-	-	-	-	24.1	24.9
13	89.9	67.9	38.8	38.8	36.3	-	-	-	-	-	-	21.1	22.2
15	81.3	67.9	38.8	38.8	36.3	31.5	26.6	-	-	-	-	18.4	19.5
16	76.8	67.9	38.8	38.8	36.3	31.5	26.6	16.9	22.9	-	-	17.0	18.5
19	62.0	58.3	38.8	38.4	36.3	31.5	26.6	16.9	22.9	19.4	-	14.4	15.6
23	43.7	41.3	38.7	37.9	33.9	29.9	25.1	16.9	22.4	19.1	15.8	11.4	12.5
26	-	32.8	36.7	36.2	31.7	28.5	23.9	16.9	21.8	18.7	15.8	-	10.7
29	-	27.0	31.0	30.6	29.4	26.9	22.5	16.9	21.2	18.3	15.5	-	9.2
33	-	21.1	24.9	24.5	26.0	24.7	20.8	16.9	20.2	17.6	15.1	-	7.6
39	-	15.3	19.1	18.6	19.9	18.8	18.6	15.5	18.8	16.5	14.7	-	5.6
46	-	-	-	14.0	15.1	14.0	15.4	13.6	14.2	14.3	13.8	-	-
52	-	-	-	11.0	12.3	11.4	12.7	12.0	11.4	11.6	11.6	-	-
59	-	-	-	8.8	9.9	8.8	10.1	10.1	9.0	9.0	9.0	-	-
65	-	-	-	-	-	7.0	8.5	8.9	7.2	7.4	7.4	-	-
72	-	-	-	-	-	5.3	7.0	7.3	5.5	5.5	5.5	-	-
79	-	-	-	-	-	4.3	5.6	6.1	4.3	4.3	4.3	-	-
85	-	-	-	-	-	-	-	5.1	3.3	3.3	3.3	-	-
92	-	-	-	-	-	-	-	4.1	2.4	2.6	2.6	-	-
98	-	-	-	-	-	-	-	-	1.8	1.8	1.8	-	-

Boom extension sequence %

Tele 1	0	80	0	40	0	60	0	0	80	90	100	0	0
Tele 2	0	0	27	40	54	60	60	100	60	90	100	0	27
Tele 3	0	0	27	40	54	60	80	100	80	90	100	0	27
Tele 4	0	0	27	40	54	60	80	100	80	90	100	0	27

*) over rear

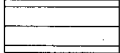
Lifting capacities main boom in 1,000 lb

13,250 lb   **22'4" x 14'5" 360°** **85%**

Radius ft	Main boom										
	33.1 ft	52.8 ft	52.8 ft	72.5 ft	72.5 ft	91.9 ft	91.9 ft	106.6 ft	111.5 ft	121.4 ft	131.2 ft
	1,000 lb										
10	92.3	-	-	-	-	-	-	-	-	-	-
11	86.8	67.9	38.8	-	-	-	-	-	-	-	-
13	75.8	67.9	38.8	38.8	36.3	-	-	-	-	-	-
15	55.8	53.0	38.8	38.8	36.3	31.5	26.6	-	-	-	-
16	48.9	46.2	38.8	38.8	36.3	31.5	26.6	16.9	22.9	-	-
19	35.0	32.7	35.3	35.1	36.0	31.5	26.6	16.9	22.9	19.4	-
23	24.1	21.9	26.1	25.7	27.2	26.1	25.1	16.9	22.4	19.1	15.8
26	-	17.3	21.1	20.6	22.2	21.1	22.4	16.9	21.0	18.7	15.8
29	-	14.2	17.5	17.1	18.4	17.3	19.1	16.9	17.6	17.2	15.5
33	-	10.4	13.9	13.7	14.8	13.7	15.3	15.7	13.9	13.9	14.2
39	-	7.2	10.3	9.9	11.0	10.1	11.6	11.9	10.3	10.3	10.3
46	-	-	-	7.2	8.1	7.2	8.7	9.0	7.4	7.4	7.4
52	-	-	-	5.4	6.5	5.4	6.9	7.2	5.6	5.6	5.6
59	-	-	-	3.9	4.8	4.1	5.3	5.5	4.2	4.4	4.4
65	-	-	-	-	-	2.9	4.2	4.5	3.1	3.2	3.2
72	-	-	-	-	-	2.0	3.3	3.5	2.0	2.2	2.2
79	-	-	-	-	-	-	2.6	2.8	-	-	-
85	-	-	-	-	-	-	-	2.2	-	-	-

Boom extension sequence %

Tele 1	0	80	0	40	0	60	0	0	80	90	100
Tele 2	0	0	27	40	54	60	80	100	80	90	100
Tele 3	0	0	27	40	54	60	80	100	80	90	100
Tele 4	0	0	27	40	54	60	80	100	80	90	100

LIFTING CAPACITIES MAIN BOOM IN 1,000 LB

6,600 lb

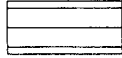



22'4" x 21' 360°

85%

Radius ft	Main boom											0° over rear		
	33.1 ft	52.8 ft	52.8 ft	72.5 ft	72.5 ft	91.9 ft	91.9 ft	106.6 ft	111.5 ft	121.4 ft	131.2 ft	33.1 ft	52.8 ft	
1,000 lb													1,000 lb	
10	104.5	-	-	-	-	-	-	-	-	-	-	25.0	-	
11	99.4	67.9	38.8	-	-	-	-	-	-	-	-	23.0	23.7	
13	89.6	67.9	38.8	38.8	36.3	-	-	-	-	-	-	20.0	21.1	
15	78.2	67.8	38.8	38.8	36.3	31.5	26.6	-	-	-	-	17.3	18.4	
16	72.7	67.7	38.8	38.8	36.3	31.5	26.6	16.9	22.9	-	-	15.9	17.4	
19	52.9	50.2	38.8	38.4	36.3	31.5	26.6	16.9	22.9	19.4	-	13.6	14.8	
23	35.8	33.4	38.2	37.8	33.9	29.9	25.1	16.9	22.4	19.1	15.8	10.5	11.8	
26	-	26.3	30.6	30.1	31.5	28.6	23.9	16.9	21.8	18.7	15.8	-	10.0	
29	-	21.1	25.3	24.9	26.6	24.9	22.5	16.9	21.2	18.3	15.5	-	8.6	
33	-	16.3	20.1	19.8	21.2	19.9	20.8	16.9	20.1	17.5	15.1	-	6.9	
39	-	11.1	15.0	14.6	16.1	14.8	16.5	15.5	15.0	15.1	14.7	-	5.1	
46	-	-	-	10.5	11.8	10.5	12.3	12.7	10.7	11.2	10.7	-	-	
52	-	-	-	7.9	9.4	8.1	9.9	10.1	8.3	8.3	8.3	-	-	
59	-	-	-	5.7	7.2	5.7	7.7	7.9	6.1	6.4	6.4	-	-	
65	-	-	-	-	-	4.6	6.3	6.5	4.7	4.7	4.7	-	-	
72	-	-	-	-	-	3.1	4.8	5.1	3.3	3.3	3.3	-	-	
79	-	-	-	-	-	2.1	3.9	3.9	2.1	2.3	2.3	-	-	
85	-	-	-	-	-	-	-	3.1	1.5	1.5	1.7	-	-	
92	-	-	-	-	-	-	-	2.4	-	-	-	-	-	
Boom extension sequence %														
Tele 1	0	80	0	40	0	60	0	0	80	90	100	0	0	
Tele 2	0	0	27	40	54	60	80	100	80	90	100	0	27	
Tele 3	0	0	27	40	54	60	80	100	80	90	100	0	27	
Tele 4	0	0	27	40	54	60	80	100	80	90	100	0	27	

*) over rear

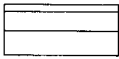
Lifting capacities main boom in 1,000 lb

6,600 lb   **22' 4" x 14' 5" 360°** **85%**

Radius ft	Main boom										
	33.1 ft	52.8 ft	52.8 ft	72.5 ft	72.5 ft	91.9 ft	91.9 ft	106.6 ft	111.5 ft	121.4 ft	131.2 ft
10	91.2	-	-	-	-	-	-	-	-	-	-
11	85.6	71.6	38.8	-	-	-	-	-	-	-	-
13	60.4	56.2	38.8	38.8	36.3	-	-	-	-	-	-
15	43.2	40.4	38.7	38.6	36.3	31.5	26.6	-	-	-	-
16	37.7	35.1	38.4	38.1	36.3	31.5	26.6	16.9	22.9	-	-
19	26.7	24.5	29.1	28.8	29.9	27.6	26.6	16.9	22.9	19.4	-
23	17.7	16.0	20.0	19.5	21.1	19.7	21.7	16.9	20.0	19.1	15.8
26	-	12.2	15.7	15.5	17.0	15.7	17.5	16.9	16.1	16.1	15.8
29	-	9.6	13.0	12.6	14.1	12.8	14.6	14.7	13.0	13.2	13.2
33	-	6.9	10.0	9.8	11.1	10.0	11.5	11.8	10.0	10.2	10.2
39	-	4.1	7.2	7.0	7.9	7.0	8.3	8.5	7.2	7.4	7.4
46	-	-	-	4.6	5.7	4.8	6.1	6.3	4.8	5.0	4.8
52	-	-	-	3.2	4.3	3.4	4.7	4.9	3.4	3.4	3.4
59	-	-	-	1.9	3.0	1.9	3.3	3.5	2.2	2.2	2.2
65	-	-	-	-	-	-	2.5	2.7	-	-	-
72	-	-	-	-	-	-	1.7	2.0	-	-	-

Boom extension sequence %

Tele 1	0	80	0	40	0	60	0	0	80	90	100
Tele 2	0	0	27	40	54	60	80	100	80	90	100
Tele 3	0	0	27	40	54	60	80	100	80	90	100
Tele 4	0	0	27	40	54	60	80	100	80	90	100

Working range main boom

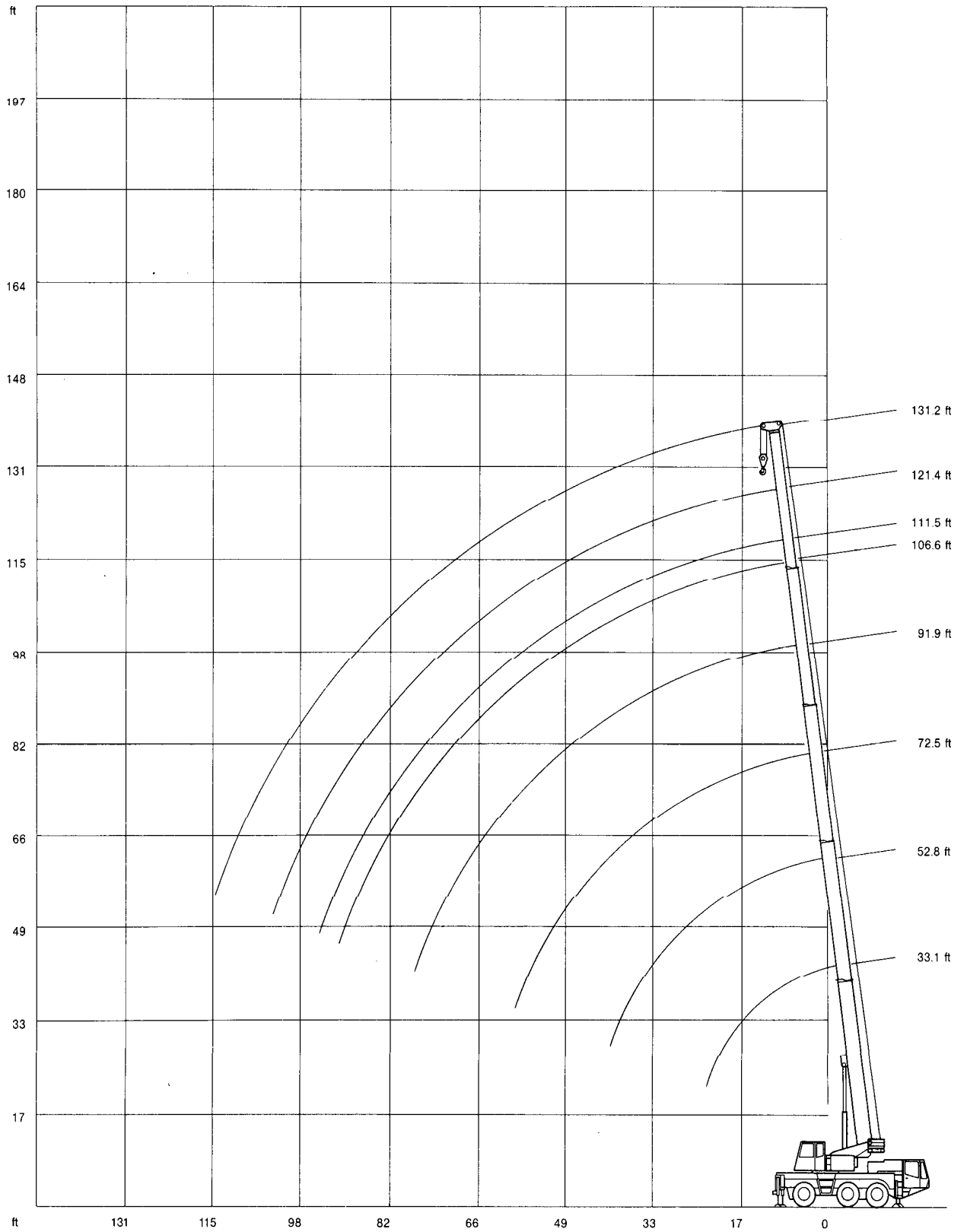

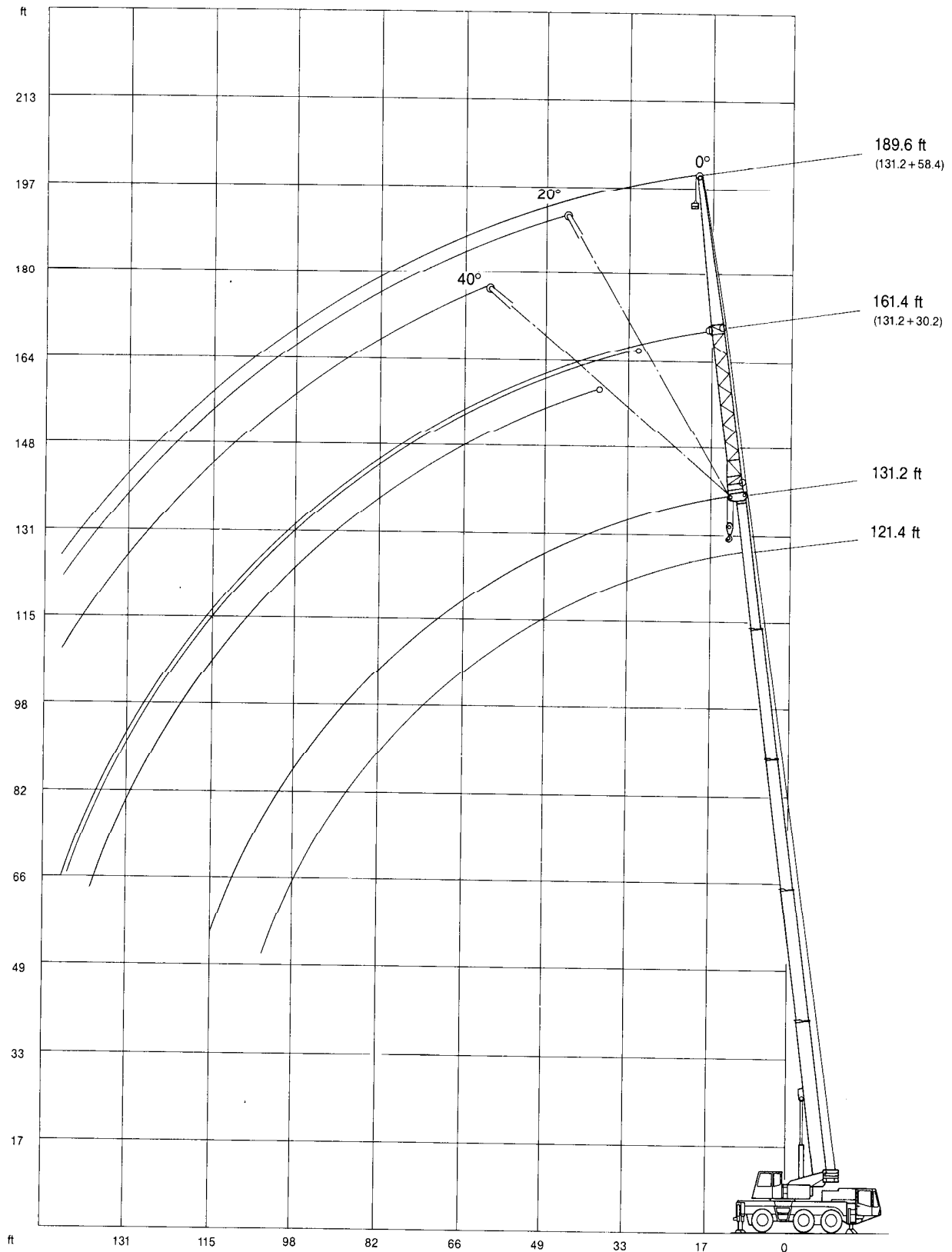

Working range main boom extension





Lifting capacities main boom extension in 1,000 lb

Main boom: 121.4 ft



19,850 lb   22'4"x21' 360° 85%

Radius	Extension					
	30.2 ft			58.4 ft		
	0°	20°	40°	0°	20°	40°
ft	1,000 lb					
26	9.7	-	-	-	-	-
29	9.7	-	-	-	-	-
33	9.6	-	-	4.1	-	-
39	9.4	8.3	-	4.1	-	-
46	9.0	8.3	7.7	4.1	-	-
52	8.8	7.9	7.5	4.1	3.9	-
59	8.1	7.7	7.2	4.1	3.9	-
65	7.9	7.3	6.8	3.9	3.9	-
72	7.5	7.0	6.8	3.9	3.5	3.3
79	6.1	6.7	6.5	3.5	3.5	3.3
85	5.1	5.5	6.1	3.5	3.3	3.3
92	4.1	4.6	4.8	3.3	3.3	3.0
98	3.1	3.5	4.2	3.3	3.1	3.0
105	2.6	2.8	3.0	2.8	3.0	2.8
111	2.0	2.2	2.4	2.2	2.8	2.8
118	1.5	1.7	-	1.7	2.4	2.6
124	-	-	-	-	2.0	2.4
131	-	-	-	-	1.5	1.7



13,250 lb   22'4"x21' 360° 85%

Radius	Extension					
	30.2 ft			58.4 ft		
	0°	20°	40°	0°	20°	40°
ft	1,000 lb					
26	9.7	-	-	-	-	-
29	9.7	-	-	-	-	-
33	9.6	-	-	4.1	-	-
39	9.4	8.3	-	4.1	-	-
46	9.0	8.3	7.7	4.1	-	-
52	8.8	7.9	7.5	4.1	3.9	-
59	8.1	7.7	7.2	4.1	3.9	-
65	7.3	7.3	6.8	3.9	3.9	-
72	5.7	6.8	6.8	3.9	3.5	3.3
79	4.5	5.2	6.1	3.5	3.5	3.3
85	3.5	4.4	4.9	3.5	3.3	3.3
92	2.6	3.2	3.5	3.0	3.3	3.0
98	2.2	2.4	2.9	2.4	3.1	3.0
105	1.5	1.9	2.2	1.9	2.6	2.8
111	-	-	1.5	-	2.2	2.6
118	-	-	-	-	1.5	1.9
124	-	-	-	-	-	1.5

Main boom: 131.2 ft

19,850 lb   22'4"x21' 360° 85%

Radius	Extension					
	30.2 ft			58.4 ft		
	0°	20°	40°	0°	20°	40°
ft	1,000 lb					
29	7.2	-	-	-	-	-
33	7.2	-	-	2.4	-	-
39	7.2	7.2	-	2.4	-	-
46	7.2	7.2	-	2.4	-	-
52	7.2	7.2	6.8	2.4	2.4	-
59	7.0	6.8	6.6	2.4	2.4	-
65	6.8	6.6	6.2	2.4	2.4	-
72	6.6	6.3	5.7	2.4	2.4	2.4
79	6.1	5.7	5.5	2.4	2.4	2.4
85	4.9	5.5	5.3	2.4	2.4	2.4
92	3.9	4.6	4.8	2.4	2.4	2.4
98	3.1	3.5	4.0	2.4	2.4	2.4
105	2.4	2.8	3.0	2.4	2.4	2.4
111	2.0	2.2	2.4	2.2	2.4	2.2
118	1.5	1.7	1.9	1.7	2.4	2.2
124	-	-	-	-	2.0	2.2
131	-	-	-	-	-	1.7

13,250 lb   22'4"x21' 360° 85%

Radius	Extension					
	30.2 ft			58.4 ft		
	0°	20°	40°	0°	20°	40°
ft	1,000 lb					
29	7.2	-	-	-	-	-
33	7.2	-	-	2.4	-	-
39	7.2	7.2	-	2.4	-	-
46	7.2	7.2	-	2.4	-	-
52	7.2	7.2	6.8	2.4	2.4	-
59	7.0	6.8	6.6	2.4	2.4	-
65	6.8	6.6	6.2	2.4	2.4	-
72	5.7	6.3	5.7	2.4	2.4	2.4
79	4.5	5.2	5.4	2.4	2.4	2.4
85	3.5	4.2	4.6	2.4	2.4	2.4
92	2.6	3.2	3.5	2.4	2.4	2.4
98	2.0	2.4	2.9	2.2	2.4	2.4
105	1.5	1.7	2.2	1.7	2.4	2.4
111	-	-	1.5	-	2.0	2.2
118	-	-	-	-	1.6	1.9
124	-	-	-	-	-	1.5

Lifting capacities main boom extension in 1,000 lb

Main boom: 121.4 ft

19,850 lb  22'4"x14'5" 360° 85%

Radius	Extension					
	30.2 ft			58.4 ft		
	0°	20°	40°	0°	20°	40°
ft	1,000 lb					
26	9.7	-	-	-	-	-
29	9.7	-	-	-	-	-
33	9.6	-	-	4.1	-	-
39	9.4	8.3	-	4.1	-	-
46	9.0	8.3	7.7	4.1	-	-
52	7.6	7.9	7.5	4.1	3.9	-
59	6.1	6.8	7.2	4.1	3.9	-
65	4.7	5.4	5.8	3.9	3.9	-
72	3.5	4.4	4.8	3.9	3.5	3.3
79	2.6	3.2	3.5	2.8	3.5	3.3
85	2.0	2.4	2.8	2.2	3.3	3.3
92	-	1.7	2.1	1.5	2.6	3.0
98	-	-	1.5	-	2.0	2.6
105	-	-	-	-	1.5	2.2
111	-	-	-	-	-	1.5

13,250 lb  22'4"x14'5" 360° 85%

Radius	Extension					
	30.2 ft			58.4 ft		
	0°	20°	40°	0°	20°	40°
ft	1,000 lb					
26	9.7	-	-	-	-	-
29	9.7	-	-	-	-	-
33	9.6	-	-	4.1	-	-
39	9.4	8.3	-	4.1	-	-
46	7.6	8.3	7.7	4.1	-	-
52	5.8	6.9	7.5	4.1	3.9	-
59	4.4	5.3	5.7	4.1	3.9	-
65	3.4	4.2	4.7	3.3	3.9	-
72	2.2	3.1	3.5	2.4	3.5	3.3
79	1.5	2.1	2.6	1.5	2.8	3.2
85	-	1.5	2.0	-	2.2	3.0
92	-	-	-	-	1.5	2.4
98	-	-	-	-	-	1.8

Main boom: 131.2 ft

19,850 lb  22'4"x14'5" 360° 85%

Radius	Extension					
	30.2 ft			58.4 ft		
	0°	20°	40°	0°	20°	40°
ft	1,000 lb					
29	7.2	-	-	-	-	-
33	7.2	-	-	2.4	-	-
39	7.2	7.2	-	2.4	-	-
46	7.2	7.2	-	2.4	-	-
52	7.2	7.2	6.8	2.4	2.4	-
59	5.7	6.8	6.6	2.4	2.4	-
65	4.7	5.4	5.8	2.4	2.4	-
72	3.5	4.2	4.6	2.4	2.4	2.4
79	2.6	3.2	3.5	2.4	2.4	2.4
85	2.0	2.4	2.8	2.0	2.4	2.4
92	-	1.7	2.1	-	2.4	2.4
98	-	-	1.5	-	1.8	2.4
105	-	-	-	-	-	1.9
111	-	-	-	-	-	1.5

13,250 lb  22'4"x14'5" 360° 85%

Radius	Extension					
	30.2 ft			58.4 ft		
	0°	20°	40°	0°	20°	40°
ft	1,000 lb					
29	7.2	-	-	-	-	-
33	7.2	-	-	2.4	-	-
39	7.2	7.2	-	2.4	-	-
46	7.2	7.2	-	2.4	-	-
52	5.8	6.8	6.9	2.4	2.4	-
59	4.2	5.3	5.7	2.4	2.4	-
65	2.9	4.0	4.7	2.4	2.4	-
72	2.0	2.8	3.5	1.9	2.4	2.4
79	-	1.9	2.3	-	2.4	2.4
85	-	-	1.7	-	2.0	2.4
92	-	-	-	-	-	2.1
98	-	-	-	-	-	1.5



Carrier

Drive/steering	6 x 4 x 6.
Frame	Monobox main frame with outrigger boxes integral, of high-grade close-grained structural steel.
Outriggers	Four hydraulically telescoping outrigger beams with hydraulic jack legs.
Engine	Daimler-Benz OM 401 LA water-cooled 6-cylinder diesel engine. Output to DIN: 213 kW (290 HP). Max. torque: 1180 Nm at 1100-1600 rpm. Fuel tank capacity: 300 l.
Transmission	ZF powershift transmission with torque converter and electr. gearshifting, transfer case with off-road range.
Axles	1st: non-drive, steering. 2nd: steering. 3rd: steering. Axles 2 and 3 with planetary hubs. Differential lock-out control: 2nd axle: longitudinal and transverse. 3rd axle: transverse.
Suspension	Hydropneumatic suspension, all axles hydraulically blockable.
Wheels and tyres	6 x 14.00 R 25 on 9.5-25 rims; tubeless road-tread tyres. All axles single-wheeled.
Steering	Dual-circuit semiblock mechanical steering with hydraulic booster.
Brakes	Service brake: dual-line air system, acting on all wheels. Parking brake: spring-loaded type. Sustained action brake: engine exhaust brake + constant decompression and butterfly valve.
Electrical equipment	24-volt system.
Cab	Rubber-mounted steel-plate 2-man cab with safety glazing and all controls.

Superstructure

Hydraulic system	Driven off carrier engine, 1 variable-displacement axial piston pump and separate fixed-displacement pump for 4 simultaneous, independent working movements.
Hoist	Fixed-displacement axial-piston motor, hoist drum with planetary reduction integral and spring-loaded holding brake.
Slew unit	Hydraulic motor with planetary reduction, foot-pedal operated brake and spring-loaded holding brake.
Derricking unit	One differential cylinder with pilot-controlled lowering brake valve.
Crane cab	Spacious all-steel comfortable cab with sliding door, large folding-out windscreen, armoured-glass roof window, controls and instrumentation for all crane movements, working light. Self-contained air heater and 7-day programmable timer, thermostat controlled. Windscreen washer and intermittent-control wiper.
Main boom	Boom base and 4 telescopic sections, telescoping with partial load, fabricated from high-grade close-grained structural steel, featuring the familiar DEMAG ovaloid design.
Counterweight	13,250 lb
Safety devices	Electronic safe load indicator with digital read-out for hook load, rated load, boom length, boom angle, load radius, analogous display to indicate the capacity utilization, limit switches on hoist and lowering motions, pressure-relief and safety holding valves.
Hydraulic servo control	Hydraulic pilot control through self-centering control levers.

Optional Equipment

Drive	6 x 6
Tyres	Optional 16.00 R 25 on 11.25-25 rims, off-road tread, tubeless.
Tow coupling	26,400 lb capacity, air-brake hook-up.
Secondary hoist	Fixed displacement axial-piston motor, hoist drum with planetary reduction integral and spring-loaded holding brake (avoids re-reeving of hoist line when using the optional jib).
Main boom extension	1- or 2-part fold-away jib, 30.2 ft or 58.4 ft, 0°, 20° and 40° offset.
Additional counterweight	6,600 lb, connects to standard counterweight, mounts hydraulically without auxiliary crane.
Heavy-lift attachment	Additional sheaves at boom head for duties over 75,680 lb.

