



80 t metric



186 kW

683 HD

Teleskopkran
Telescopic Crane



SENEBOGEN®

- Traglasten 80 t
- Motorleistung 186 kW (253 PS)
- Modernste Load Sensing Hydraulikanlage
- Robuste, sehr servicefreundliche Konzeption
- Starkes B7 Traktoren-Laufwerk
- Kontinuierlich ausschiebbarer Teleskopausleger

Technische Daten



Motor

Deutz-Dieselmotor TCD2013L062V, mit Direkteinspritzung, wassergekühlt. Leistung nach DIN/ISO: 186 kW (253 PS) bei 2000 min⁻¹.

Trockenluftfilter mit Zyklonvorabscheider, Sicherheitselement und Verschmutzungsanzeige im Fahrerhaus. Kraftstoffvolumen: 550 l.

Elektrische Anlage: 24 Volt
2 Kaltstart-Hochleistungsbatterien



Hydraulik

Load-Sensing-Hydrauliksystem mit lastdruckunabhängiger Volumenstromsteuerung, Druckabschneidung und energiesparender Bedarfsstromsteuerung.

Durch die unabhängige und proportionale Zuteilung des Pumpenförderstroms können mehrere Arbeitsfunktionen gleichzeitig und unabhängig voneinander präzise gesteuert werden.

Geringe Strömungsverluste durch große Leitungsquerschnitte und großdimensionierte Steuerventile.

Load-Sensing-Leistungsregelung. Eigener, separater Hydraulikkreis für den Drehantrieb. Individuelle, feinfühligere Drehwerkssteuerung und optimale Bewegungsharmonie.

Axialkolbenpumpen mit Fördermenge 1 x 520 l/min, 1x 80 l/min Betriebsdruck 330 bar Hydrauliktankvolumen 1350/1150 l

Hydraulikölfilter mit Langzeitwechselintervall. Gesunde Öltemperatur durch großdimensionierte Hydraulikkühlung. Zentrales Servicetableau zum einfachen und schnellen Überprüfen der gesamten Hydraulikanlage. Servokreuzschalthebel für Arbeitsbewegungen und Zusatzfunktionen nach ISO-System.



Drehantrieb

Separater Hydraulikkreis, Axialkolbenmotor, federbelastete, hydraulisch löfbbare Sicherheitslamellenbremse, Planetengetriebe und Drehwerksritzel. Großdimensionierter Drehkranz. Drehgeschwindigkeit 0 bis 2,0 min⁻¹, stufenlos regelbar. Im Motor integrierte Bremsventile sorgen für eine verschleißfreie Abbremsung.



Unterwagen 683 HD

Stabile Schweißkonstruktion in verwindungssteifer Bauweise. Hydraulischer Fahrtrieb je Fahrwerksseite durch einen Axialkolbenmotor über ein Kompaktplanetengetriebe im Fahrwerksrahmen integriert und zusätzlich durch Abdeckungen geschützt. Federbelastete hydraulisch löfbbare Lamellenbremsen als Sicherheitsfeststellbremsen.

Version I:

Unterwagen hydraulisch teleskopierbar Tele 83/390.

Version II:

Starlifter Unterwagen R87/440 in Breitspurversion, Spurbreite 4,4 m, 4 Unterwagen Abstützzylinder, abnehmbare Laufwerke für den Transport.

Wartungsfreies Traktorenlaufwerk B7 mit 3-Steg-Bodenplatten und hydraulischer Kettenspannung. Fahrgeschwindigkeit 0 – 2,5 km/h, 2-Stufen-Hydraulikfahrmotore. Sehr gute Geländegängigkeit durch hohe Zugleistung und gute Bodenfreiheit. Auf Wunsch: 900 mm Flachbodenplatten.



Oberwagen

Verwindungssteifer Oberrahmen mit durchgehenden Lagerschilden für optimierte Krafteinleitung, präzisionsbearbeitet. Stahlbüchsen im Bereich der Auslegeranlenkungspunkte. Spezialschalldämmung für den Motor. Ausgezeichnetes Design.



Fahrerkabine

MAXcab

SENNEBOGEN maXcab mit Schiebetüre, exzellente Ergonomie, Heiz-Klimaautomatik mit Temperaturvorwahl und Frischluft / Umluftfilter, Komfortsitz luftgedefert optional einstellbar, ausgezeichnete Rundumsicht, SENNEBOGEN Diagnostic System



Arbeitsausrüstung

Teleskopausleger 5-teilig mit Rollenkopf, hydr. teleskopierbar. Hubzylinder und Teleskopzylinder mit Rohrbruchsicherheitsventilen.

Antrieb der Hubwinde über Axialkolbenmotor mit angebautelem Bremsventil und Planetengetriebe mit Sicherheitslamellenbremse im Ölbad. Zugkraft (1. Lage) max. 72 kN, Seilgeschwindigkeit max. 0 – 95 m/min, Seildurchmesser 20 mm,

Spitzenausleger neigbar (0°/20°/40°), sehr schnell und einfach ohne Hilfsgerät aufrüstbar, bei Nichteinsatz wird dieser seitlich am Grundausleger verriegelt. Komplette Sicherheitseinrichtung entsprechend den deutschen und europäischen Vorschriften. Elektronische Lastmomentbegrenzung (LMB) mit Klartextanzeige von Winkel, Auslegerlänge und Ausladung, Hubendschalter, Seilablaufsicherung.

Zertifiziert nach Richtlinien.



Einsatzgewicht 683 HD

Einsatzgewicht mit Teleskopausleger 42 m, Spitzenausleger, 20 t Haken und Laufwerk B7 mit 700 mm 3 Steg- Bodenplatten, 1 Hubwinde

683 HD mit hydr. teleskopierbarem Unterwagen, Ballast 20,5 t und 13 t Unterwagenballast

ca.: **83,5 t**

683 HD Star-Lifter mit Breitspurunterwagen, Ballast 25,9 t und 6 t Unterwagenballast, 1 Hubwinde

ca.: **84,3 t**

Achtung:

Die angegebenen Gewichte können sich durch verschiedene Ausstattungen ändern.

Technische Änderungen vorbehalten!

- Lifting Capacity 80 t
- Engine output 186 kW (253 HP)
- State-of-art load-sensing hydraulic system
- Robust, very service-friendly design
- Strong B7 tractor tracks
- Continuously extension of the telescopic boom

Specifications



Engine

Deutz Diesel engine TDC2013L062V, with direct injection, water-cooled. Output as per DIN/ISO: 186 kW (253 HP) at 2000 rpm.
Dry air filter with cyclone preliminary filter, safety element and pollution indicator.
Fuel tank capacity: 550 l.

Electric system 24 Volt
2 highly efficient cold starting batteries



Hydraulic System

Load-sensing hydraulic-system.
The variable displacement piston pump is equipped with pressure cut-off function and with a energy-saving flow-on-demand control.
Through the independent and proportional feed of the oil flow all working functions can be operated parallelly, independently and very precisely.
High efficiency through well designed hydraulic valves and lines.
Separate hydraulic circuit for the swing drive. Individually and precisely swing operation.

Axial piston pumps
Flow rates 1 x 520 l/min, 1 x 80 l/min working pressure 330 bar
Hydraulic tank capacity 1350/1150 l

Hydraulic oil filter with long time change interval. Healthy oil temperature through high dimensioned hydraulic oil cooler. Central service board for easy and rapid check of complete hydraulic-system.
Servo joy sticks for operating movements and additional functions as per ISO-System.



Swing System

The swing operation is driven independently through an axial piston motor, spring-loaded hydraulically releasable multiple-disk brake, planetary gear and pinion shaft.
Large dimensioned swing bearing.
Swing speed 0 – 2.0 rpm, infinitely controllable.
Hydraulic motor with integrated brake valves for reduction of wear in braking system to a minimum.



Undercarriage 683 HD

Each track is independently driven by an axial piston motor through planetary final drive. The drives are integrated into the track frames and protected by covers. Spring loaded hydraulically releasable multiple-disk brakes as safety parking brakes for reliable stopping.

Version I:
Undercarriage hydraulically extendable
Tele 83/390.
Version II:
Starlifter undercarriage R87/440 in wide gauge version, gauge width 4.4 m, 4 hydr. cylinders, removable side frames for transport.

Maintenance-free track-type B7 with triple-bar-grouser track pads and hydraulic track-tensioning device.
Travel speed 0-2.5 km/h, 2-speed travel motors. High traction force and good ground clearance to ensure excellent rough terrain travel.
Option: 900 mm flat track shoes



Upper Structure

Torsion-free upper frame with continuous bearing-plates for optimal power introduction, precision machined. Steel-bushes for the boom-pivot. Special sound insulation for the engine. Excellent design.



Operator's Cab maXcab

SENNEBOGEN maXcab with sliding door, excellent ergonomics, automatic heating/air conditioning with temperature pre-select and fresh air/recirculation filter, air suspended comfort seat optionally adjustable, excellent 360° visibility, SENNEBOGEN Diagnostics System



Working Equipment

Telescopic five-section boom, hydr. extend- and retractable.
Boom hoist cylinder and telescopic cylinder with safety check valves. Hoist winch via hydraulic motor with safety valve and planetary gear with safety multi-disk-brake in the oil bath.
Line pull (1st layer) max. 72 kN, hoist speed max. 0 – 95 m/min, rope dia. 20 mm. Jib, adjustable (0°/20°/40°), it can be mounted very fast and very easily without any helping devices.

If fly jib is not used, it can be locked on the side of the main boom.
Safety equipment according German and European regulations.
Safe load indicator (SLI) with clear text indication of boom angle, boom length and radius, hoist end switch.

Certification according to  regulations.



Service Weight 683 HD

Service weight with 42 m telescopic boom, jib, 20 t hook and track-type B7 with 700 mm triple-bar track shoes, 1 hoist winch

683 HD with hydraulically extendable undercarriage, counterweight 20,5 t, carbody counterweight 13 t

approx.: **83.5 t**

683 HD Star-Lifter with wide gauge undercarriage, counterweight 25.9 t, carbody counterweight 6 t, 1 hoist winch

approx.: **84.3 t**

Note:
The shown weights may vary with different equipment!

Subject to technical modification!

683 HD mit hydraulisch teleskopierbarem Unterwagen Tele 83/390, Laufwerk B7
683 HD with hydraulically extendable undercarriage Tele 83/390, B7 tracks

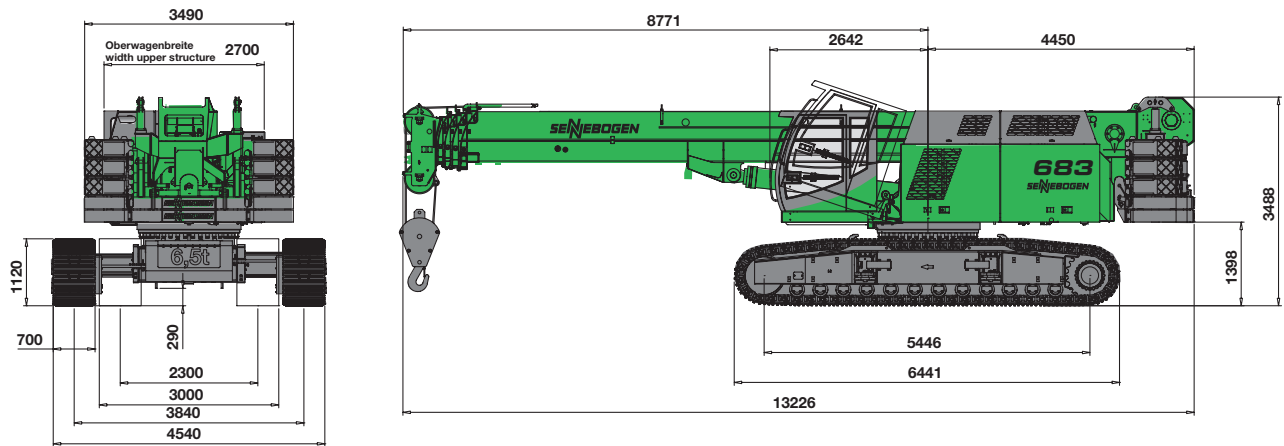

Grundmaschine mit Gegengewicht 20 t + 13 t Unterwagenballast
base machine with counterweight 20 t + 13 t carbody counterweight

683 HD mit Starlifter Unterwagen Tele 87/440, Laufwerk B7
683 HD with Star-Lifter undercarriage Tele 87/440, B7 tracks

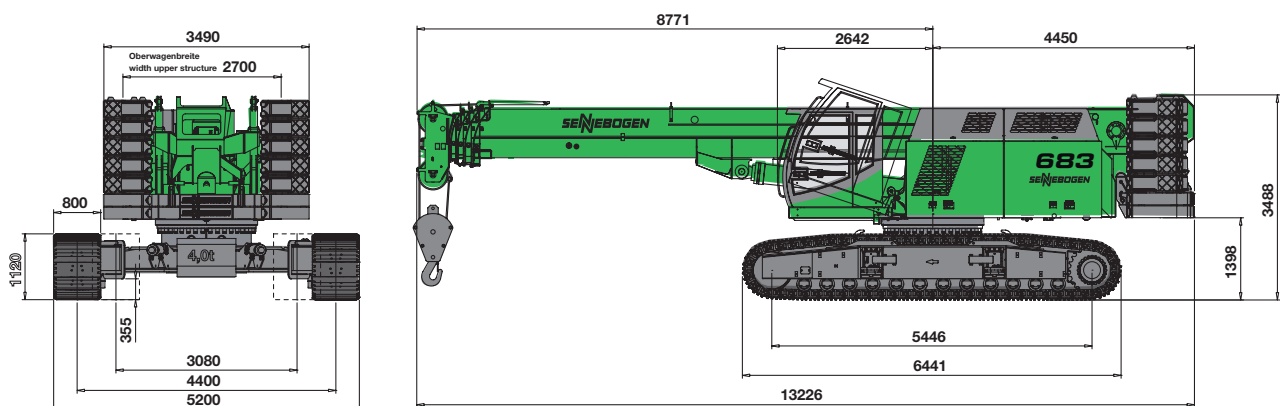

Grundmaschine mit Gegengewicht 25,9 t + 6 t Unterwagenballast
base machine with counterweight 25.9 t + 6 t carbody counterweight

Min. Unterwagenbreite bei Spurbreite von 3080 mm = 4050 mm
Min. width of undercarriage at gauge width of 3080 mm = 4050 mm

Kranausrüstung (Teleskopausleger 42 m)
crane equipment (telescopic boom 42 m)

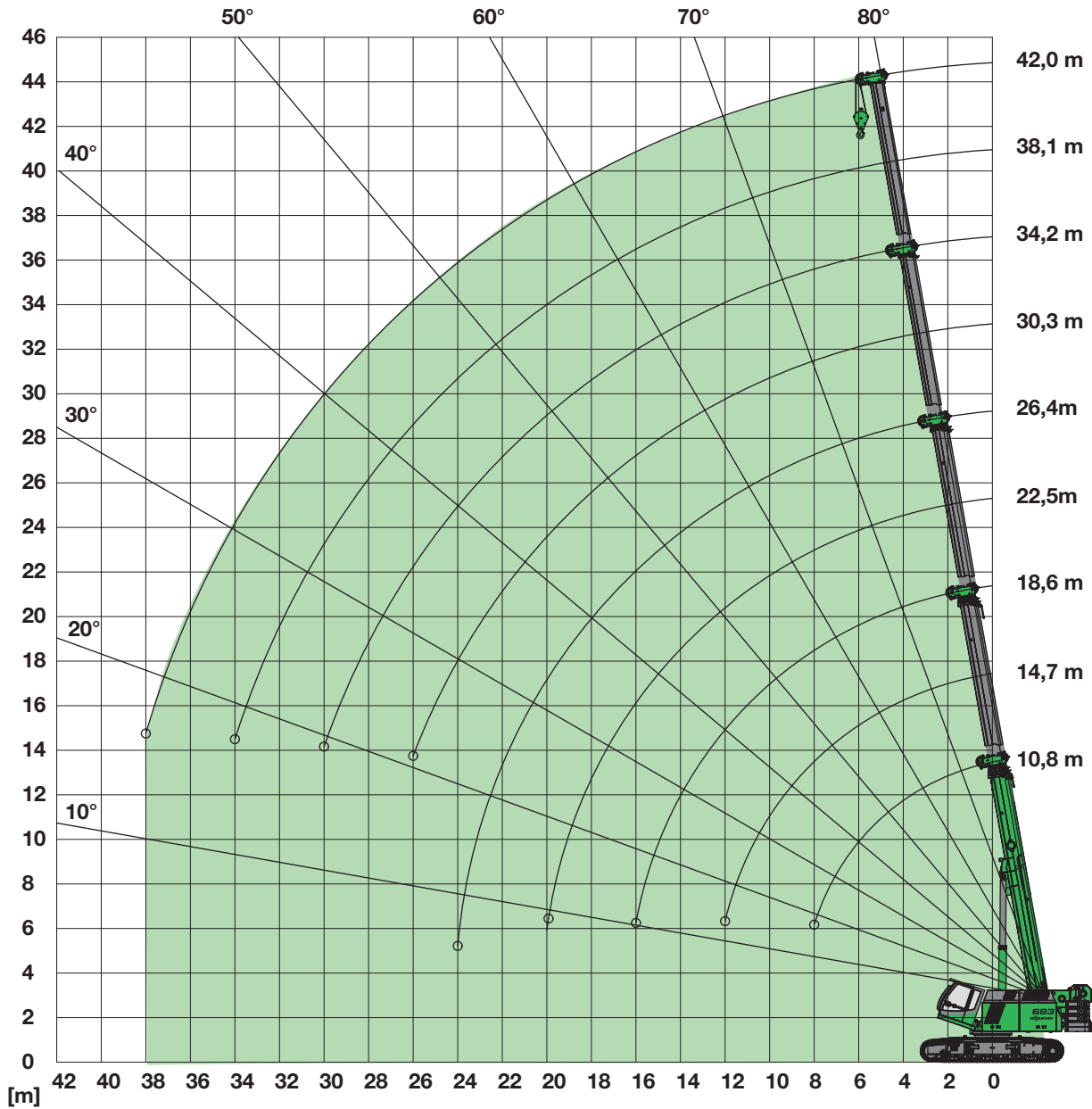

Haken
hooks

Kapazität capacity	Gewicht weight	Seileinscherung und max. Traglast - no. of hoist reeving and max. rated load							
		8	7	6	5	4	3	2	1
10 t	200 kg								7.200 kg
20 t 1-rollig	325 kg						20.000 kg	14.400 kg	7.200 kg
50 t 3-rollig	675 kg		50.000 kg	43.200 kg	36.000 kg	28.800 kg	21.600 kg	14.400 kg	7.200 kg

Kran-Traglasten mit Teleunterwagen crane load chart with extendable undercarriage

Gegengewicht 20,5 t
Unterwagenballast 13 t

counterweight 20,5 t
carbody counterweight 13 t

Ausladung radius [m]	Auslegerlänge / boom length [m]								
	10,8	14,7	18,6	22,5	26,4	30,3	34,2	38,1	42,0
2,5	80,0*								
3,0	72,5	50,0	40,0						
3,5	67,1	50,0	40,0						
4,0	62,4	50,0	40,0	31,5					
5,0	53,8	47,4	36,9	31,4	26,0				
6,0	40,4	37,6	32,9	28,6	24,6	19,0			
7,0	31,5	30,7	28,3	26,0	23,0	19,0	14,0		
8,0	25,6	24,8	23,9	22,7	21,3	18,9	14,0	12,0	9,5
9,0		20,7	20,2	19,6	18,8	17,8	14,0	12,0	9,5
10,0		17,5	17,1	17,0	16,4	16,1	14,0	12,0	9,5
11,0		15,1	14,7	14,9	14,4	14,3	13,8	12,0	9,5
12,0		13,1	12,7	12,9	12,8	12,7	12,6	11,8	9,5
13,0			11,1	11,3	11,4	11,4	11,3	11,3	9,5
14,0			9,7	9,9	10,0	10,2	10,2	10,3	9,5
15,0			8,5	8,7	8,8	9,2	9,2	9,4	9,4
16,0			7,5	7,7	7,8	8,2	8,4	8,6	8,7
17,0				6,9	7,0	7,3	7,6	7,8	8,0
18,0				6,1	6,2	6,6	6,9	7,2	7,3
19,0				5,4	5,5	5,9	6,2	6,6	6,7
20,0				4,8	4,9	5,3	5,6	6,0	6,2
21,0					4,4	4,8	5,0	5,4	5,7
22,0					3,9	4,3	4,5	4,9	5,3
23,0					3,5	3,8	4,1	4,5	4,8
24,0					3,1	3,4	3,7	4,1	4,4
25,0						3,1	3,3	3,7	4,0
26,0						2,7	3,0	3,4	3,7
27,0							2,7	3,1	3,4
28,0							2,4	2,8	3,1
29,0							2,1	2,5	2,8
30,0							1,9	2,3	2,6
32,0								1,8	2,1
34,0								1,4	1,7
36,0									1,4
38,0	Tab.-Nr.: 683R-75/1997/20.5/06.04 HA42								
Strangzahl / parts reeving	12	7	6	5	4	3	2	2	2
I	0%	50%	100%	100%	100%	100%	100%	100%	100%
II	0%	0%	0%	50%	100%	100%	100%	100%	100%
III	0%	0%	0%	0%	0%	50%	100%	100%	100%
IV	0%	0%	0%	0%	0%	0%	0%	50%	100%
Bei angebautem Spitzenanleger am Grundkörper müssen die Traglastwerte reduziert werden. When the jib is mounted at the basic main boom the rated loads have to be reduced.									
Traglastreduzierung reduction of load	1030kg	760kg	600kg	500kg	420kg	370kg	320kg	290kg	270kg

Anmerkung:

- Die angegebenen Traglastwerte gelten für ebenen und festen Stand der Maschine.
- Traglastwerte sind in Tonnen angegeben und gelten für 360 Grad.
- Die Traglasten berücksichtigen die Normen DIN 15019/2 und ISO 4305
- Das Gewicht der Lastaufnahmemittel (Haken, Gehänge) ist von den Traglasten abzuziehen.
- Die Traglastwerte gelten für maximale Unterwagenspurbreite.
- Lastwerte müssen begrenzt oder vermindert werden, um ungünstige Bedingungen zu berücksichtigen, wie weichen oder unebenen Boden, schräge Gefälle, Wind, Seitenlasten, schwingende Lasten, Rucken oder plötzliches Stoppen der Ladungen, Unerfahrenheit des Personals, Fahren mit Last.
- Zulässiger Seilzug je Strang bei Kranbetrieb ist bei Seildurchmesser 20 mm - 7.200 kg
- Die angegebenen Traglastwerte sind nur zur Orientierung. Die jeweils gültigen Traglastwerte entnehmen Sie bitte den Tabellen in der Betriebsanleitung.
- Die Werte, die mit * gekennzeichnet sind, gelten nur mit Sonderausstattung.

Kran-Traglasten Star-Lifter crane load chart Star-Lifter

Gegengewicht	25,9 t	counterweight	25,9 t
Unterwagenballast	6 t	carbody counterweight	6 t

Ausladung radius [m]	Auslegerlänge / boom length [m]									
	10,8	14,7	18,6	22,5	26,4	30,3	34,2	38,1	42,0	
2,5	80,0*									
3,0	72,5	50,0	40,0							
3,5	67,1	50,0	40,0							
4,0	62,4	50,0	40,0	31,5						
5,0	54,7	50,0	36,9	31,4	26,0					
6,0	48,3	45,1	32,9	28,6	24,6	19,0				
7,0	41,7	40,1	29,3	26,0	23,0	19,0	14,0			
8,0	33,4	32,6	26,2	23,6	21,3	18,9	14,0	12,0	9,5	
9,0		26,8	23,6	21,5	19,6	17,8	14,0	12,0	9,5	
10,0		22,6	21,5	19,6	18,0	16,7	14,0	12,0	9,5	
11,0		19,4	19,0	17,8	16,5	15,5	13,8	12,0	9,5	
12,0		16,9	16,5	16,3	15,1	14,3	13,1	11,8	9,5	
13,0			14,5	14,7	13,8	13,2	12,4	11,3	9,5	
14,0			12,8	13,0	12,7	12,2	11,7	10,8	9,5	
15,0			11,4	11,5	11,7	11,3	11,0	10,3	9,4	
16,0			10,1	10,3	10,4	10,5	10,3	9,8	9,1	
17,0				9,2	9,3	9,7	9,6	9,3	8,7	
18,0				8,3	8,4	8,8	9,0	8,9	8,3	
19,0				7,4	7,6	7,9	8,2	8,4	8,0	
20,0				6,7	6,8	7,2	7,5	7,9	7,6	
21,0					6,2	6,5	6,8	7,2	7,2	
22,0					5,6	6,0	6,2	6,6	6,9	
23,0					5,1	5,4	5,7	6,1	6,4	
24,0					4,6	4,9	5,2	5,6	5,9	
25,0						4,5	4,8	5,2	5,5	
26,0						4,1	4,4	4,8	5,1	
27,0							4,0	4,4	4,7	
28,0							3,6	4,0	4,4	
29,0							3,3	3,7	4,0	
30,0							3,0	3,4	3,7	
32,0								2,9	3,2	
34,0								2,4	2,7	
36,0									2,3	
38,0	Tab.-Nr.: 683R-75/2277/25.9/11.09HA42									2,0
Strangzahl / parts reeving	12	7	6	5	4	3	2	2	2	
I	0%	50%	100%	100%	100%	100%	100%	100%	100%	
II	0%	0%	0%	50%	100%	100%	100%	100%	100%	
III	0%	0%	0%	0%	0%	50%	100%	100%	100%	
IV	0%	0%	0%	0%	0%	0%	0%	50%	100%	
	Bei angebautem Spitzenanleger am Grundkörper müssen die Traglastwerte reduziert werden. When the jib is mounted at the basic main boom the rated loads have to be reduced.									
Traglastreduzierung reduction of load	1030kg	760kg	600kg	500kg	420kg	370kg	320kg	290kg	270kg	

Notes:

- The rated loads shown are based on the machine on firm level ground without travelling.
- The rated loads shown are in metric tons valid for 360 degrees swing.
- Liftcrane capacities are calculated to comply with DIN 15019/2 and ISO 4305
- The rated loads shown include the weight of all lifting attachments, such as hook and bucket.
- In operation crawler must be extended.
- The users must derate or limit the lifted loads to allow for adverse conditions such as soft or uneven ground, out of level conditions, wind, side loads, pendulum action, jerking or sudden stopping of loads, inexperience of personnel and travelling with a load.
- Max. single line pull for crane operation with rope diameter 20 mm - 7.200 kg
- The lifting capacities above are for reference only.
For actual lifting capacities please refer to load chart in operator's manual.
- The values marked with * are valid with special equipment.

Spitzenausleger 10 m / 16 m

jib 10 m / 16 m

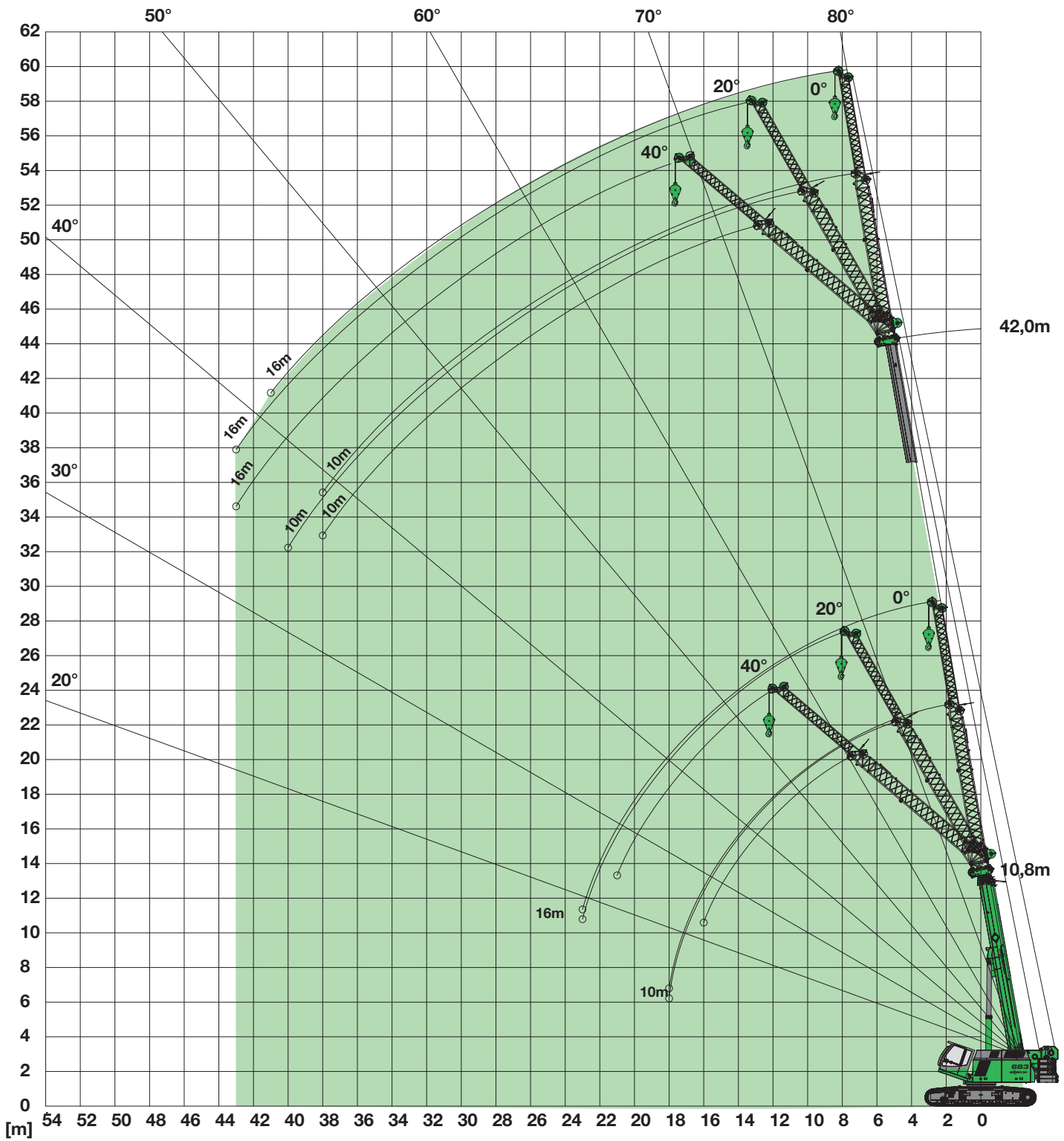

Kran-Traglasten crane load chart

Spitzenausleger / jib 10 m

Ausladung / radius [m]	Auslegerlänge - boom length [m]														
	10,8			18,6			26,4			34,2			42,0		
	0°	20°	40°	0°	20°	40°	0°	20°	40°	0°	20°	40°	0°	20°	40°
3,0	13,7														
4,0	12,2														
5,0	10,9			12,3											
6,0	9,7	6,9		11,5											
7,0	8,7	6,4		10,7			10,9								
8,0	7,9	6,0	5,0	9,9	6,7		10,4								
9,0	7,2	5,7	4,8	9,2	6,3		10,0			8,5					
10,0	6,6	5,4	4,6	8,6	6,1	4,9	9,5	6,4		8,5					
12,0	5,7	4,9	4,3	7,4	5,6	4,6	8,7	6,0	4,7	8,3	6,1		5,2		
14,0	5,0	4,4	4,1	6,5	5,2	4,4	7,8	5,6	4,6	7,8	5,7	4,6	5,2	5,2	
16,0	4,5	4,2	4,0	5,8	4,8	4,2	7,1	5,3	4,4	7,3	5,4	4,5	5,2	5,2	4,4
18,0		4,1	4,0	5,3	4,5	4,1	6,4	5,0	4,3	6,8	5,2	4,4	5,2	5,2	4,2
20,0				4,9	4,3	4,0	5,8	4,8	4,2	5,7	5,0	4,3	5,2	5,0	4,2
22,0				4,6	4,1		4,8	4,5	4,0	4,7	4,7	4,2	4,9	4,8	4,1
24,0				4,2	4,0		3,9	4,3	3,9	3,9	4,4	4,1	4,1	4,5	4,1
26,0					3,4		3,2	3,5	3,5	3,2	3,6	3,8	3,4	3,9	4,0
28,0							2,6	2,8		2,6	2,9	3,1	2,8	3,3	3,5
30,0							2,0	2,2		2,1	2,3	2,4	2,3	2,7	2,9
32,0							1,6	1,7		1,5	1,8	1,9	1,9	2,2	2,3
34,0								1,2		1,1	1,3		1,5	1,7	1,7
36,0										0,8	0,9		1,2	1,3	1,4
38,0													0,8	0,9	1,0
40,0															
Tab.-Nr.: 683R-75/1997/20.5/06.04SA10															
Strangzahl parts reeving	2	1	1	2	1	1	2	1	1	2	1	1	1	1	1
I		0%		100%			100%			100%			100%		
II		0%		0%			100%			100%			100%		
III		0%		0%			0%			100%			100%		
IV		0%		0%			0%			0%			100%		

Anmerkung:

- Die angegebenen Traglastwerte gelten für ebenen und festen Stand der Maschine.
- Traglastwerte sind in Tonnen angegeben und gelten für 360 Grad.
- Die Traglasten berücksichtigen die Normen DIN 15019/2 und ISO 4305
- Das Gewicht der Lastaufnahmemittel (Haken, Gehänge) ist von den Traglasten abzuziehen.
- Die Traglastwerte gelten für maximale Unterwagenspurbreite.
- Lastwerte begrenzt oder vermindert werden, um ungünstige Bedingungen zu berücksichtigen, wie weichen oder unebenen Boden, schräge Gefälle, Wind, Seitenlasten, schwingende Lasten, Rucken oder plötzliches Stoppen der Ladungen, Unerfahrenheit des Personals, Fahren mit Last.
- Zulässiger Seilzug je Strang bei Kranbetrieb ist bei Seildurchmesser 20 mm - 7.200 kg
- Die angegebenen Traglastwerte sind nur zur Orientierung. Die jeweils gültigen Traglastwerte entnehmen Sie bitte den Tabellen in der Betriebsanleitung.

Notes:

- The rated loads shown are based on the machine on firm level ground without travelling.
- The rated loads shown are in metric tons valid for 360 degrees swing.
- Liftcrane capacities are calculated to comply with DIN 15019/2 and ISO 4305
- The rated loads shown include the weight of all lifting attachments, such as hook and bucket.
- In operation crawler must be extended.
- The users must derate or limit the lifted loads to allow for adverse conditions such as soft or uneven ground, out of level conditions, wind, side loads, pendulum action, jerking or sudden stopping of loads, inexperience of personnel and travelling with a load.
- Max. single line pull for crane operation with rope diameter 20 mm - 7.200 kg
- The lifting capacities above are for reference only. For actual lifting capacities please refer to load chart in operator's manual.

Spitzenausleger / jib 16 m

Ausladung radius [m]	Auslegerlänge - boom length [m]														
	10,8			18,6			26,4			34,2			42,0		
	0°	20°	40°	0°	20°	40°	0°	20°	40°	0°	20°	40°	0°	20°	40°
4,0	6,1														
5,0	5,6														
6,0	5,1			5,6											
7,0	4,7			5,2											
8,0	4,3			4,9											
9,0	4,0			4,6			4,9								
10,0	3,7	3,0		4,3			4,6								
12,0	3,2	2,7		3,9	2,8		4,2			4,2					
14,0	2,9	2,5	2,2	3,5	2,7		3,9	2,8		4,0			3,4		
16,0	2,6	2,3	2,0	3,1	2,5	2,1	3,6	2,7		3,7	2,7		3,4		
18,0	2,4	2,1	1,9	2,9	2,4	2,0	3,3	2,5	2,1	3,5	2,6		3,3		
20,0	2,2	2,0	1,8	2,7	2,2	2,0	3,0	2,4	2,0	3,3	2,5	2,1	3,2	2,5	
22,0	2,0	1,9	1,8/21m	2,5	2,1	1,9	2,8	2,3	2,0	3,1	2,4	2,0	3,0	2,4	2,0
24,0	1,9/22m	1,8/23m		2,3	2,0	1,8	2,7	2,2	1,9	2,9	2,3	2,0	2,9	2,3	2,0
26,0				2,1	1,9	1,8	2,5	2,1	1,9	2,8	2,2	1,9	2,8	2,2	1,9
28,0				2,0	1,9	1,8/27m	2,4	2	1,8	2,6	2,1	1,9	2,7	2,2	1,9
30,0				1,9	1,8		2,2	1,9	1,8	2,5	2,1	1,8	2,6	2,1	1,9
32,0					1,8/31m	1,8/31m	2,1	1,9	1,8/31m	2,4	2,0	1,8	2,5	2,1	1,8
34,0							2,0	1,8		2,0	1,9	1,8	2,2	2,0	1,8
36,0							1,6	1,8		1,6	1,9	1,8	1,8	2,0	1,8
38,0							1,3	1,5/37m		1,3	1,6	1,8/37m	1,5	1,9	1,8
40,0								1,0/39m					1,3	1,6	1,8
42,0										1,0/41m			1,0/41m	1,3	1,5
44,0														1,0/43m	1,2/43m
Tab.-Nr.: 683R-75/1997/20.5/12.07SA16															
Strangzahl parts reeving	1	1	1	1	1	1	1	1	1	1	1	1	1	1	1
I		0%		100%			100%			100%			100%		
II		0%		0%			100%			100%			100%		
III		0%		0%			0%			100%			100%		
IV		0%		0%			0%			0%			100%		

Kran-Traglasten mit Teleunterwagen crane load chart with extendable undercarriage

Gegengewicht 20,5 t
Unterwagenballast 13 t

counterweight 20,5 t
carbody counterweight 13 t

Position 1

Ausladung Radius[m]	Auslegerlänge / boom length [m]								
	10,8	14,7	18,6	22,5	26,4	30,3	34,2	38,1	42,0
3,0	14,4								
3,5	14,4								
4,0	14,4	14,4							
5,0	14,4	14,4							
6,0	14,4	14,4	14,4						
7,0	14,4	14,4	14,4	14,4					
8,0	14,4	14,4	14,4	14,4	14,4				
9,0	14,4	14,4	14,4	14,4	14,4				
10,0	14,4 / 9,5	14,4	14,4	14,4	14,4	14,4			
11,0		14,4	14,4	14,4	14,4	14,3	13,2		
12,0		13,1	12,7	12,9	12,8	12,7	12,6	11,0	
13,0		11,5	11,1	11,3	11,4	11,4	11,3	10,8	
14,0		10,1 / 13,5	9,7	9,9	10,0	10,2	10,2	10,3	9,0
15,0			8,5	8,7	8,8	9,2	9,2	9,4	8,9
16,0			7,5	7,7	7,8	8,2	8,4	8,6	8,7
17,0			6,6	6,9	7,0	7,3	7,6	7,8	8,0
18,0			5,8 / 17,5	6,1	6,2	6,6	6,9	7,2	7,3
19,0				5,4	5,5	5,9	6,2	6,6	6,7
20,0				4,8	4,9	5,3	5,6	6,0	6,2
21,0				4,3	4,4	4,8	5,0	5,4	5,7
22,0				3,7 / 21,5	3,9	4,3	4,5	4,9	5,3
23,0					3,5	3,8	4,1	4,5	4,8
24,0					3,1	3,4	3,7	4,1	4,4
25,0					2,7	3,1	3,3	3,7	4,0
26,0					2,4 / 25,5	2,7	3,0	3,4	3,7
27,0						2,4	2,7	3,1	3,4
28,0						2,1 / 27,5	2,4	2,8	3,1
29,0							2,1	2,5	2,8
30,0							1,9	2,3	2,6
32,0							1,4	1,8	2,1
34,0								1,4	1,7
36,0								1,0 / 35,5	1,4
38,0									1,1
40,0									1,1

Tab.-Nr.: 683R-75/1997/20.5/02.05 S1

Strangzahl / parts reeving	2	2	2	2	2	2	2	2	2
I	0%	50%	100%	100%	100%	100%	100%	100%	100%
II	0%	0%	0%	50%	100%	100%	100%	100%	100%
III	0%	0%	0%	0%	0%	50%	100%	100%	100%
IV	0%	0%	0%	0%	0%	0%	0%	50%	100%

Schnabelausleger 14,4 t jib 14,4 t

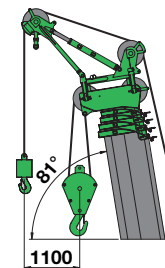
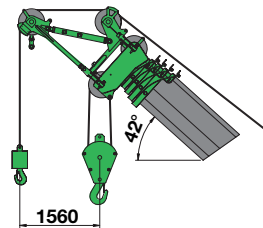

Position 1

Position 2

Position 2

Ausladung Radius[m]	Auslegerlänge / boom length [m]								
	10,8	14,7	18,6	22,5	26,4	30,3	34,2	38,1	42,0
3,0	14,4	14,4	14,4						
3,5	14,4	14,4	14,4						
4,0	14,4	14,4	14,4	14,4					
5,0	14,4	14,4	14,4	14,4					
6,0	14,4	14,4	14,4	14,4	14,4				
7,0	14,4	14,4	14,4	14,4	14,4	14,4			
8,0	14,4	14,4	14,4	14,4	14,4	14,4	14,0		
9,0	14,4	14,4	14,4	14,4	14,4	14,4	14,0	11,0	9,0
10,0	14,4 / 9,5	14,4	14,4	14,4	14,4	14,4	13,9	11,0	9,0
11,0		14,4	14,4	14,4	14,4	14,3	13,8	11,0	9,0
12,0		13,1	12,7	12,9	12,8	12,7	12,6	11,0	9,0
13,0		11,5	11,1	11,3	11,4	11,4	11,3	10,8	9,0
14,0		10,1 / 13,5	9,7	9,9	10,0	10,2	10,2	10,3	9,0
15,0			8,5	8,7	8,8	9,2	9,2	9,4	8,9
16,0			7,5	7,7	7,8	8,2	8,4	8,6	8,7
17,0			6,6	6,9	7,0	7,3	7,6	7,8	8,0
18,0			5,8 / 17,5	6,1	6,2	6,6	6,9	7,2	7,3
19,0				5,4	5,5	5,9	6,2	6,6	6,7
20,0				4,8	4,9	5,3	5,6	6,0	6,2
21,0				4,3	4,4	4,8	5,0	5,4	5,7
22,0				3,7 / 21,5	3,9	4,3	4,5	4,9	5,3
23,0					3,5	3,8	4,1	4,5	4,8
24,0					3,1	3,4	3,7	4,1	4,4
25,0					2,7	3,1	3,3	3,7	4,0
26,0					2,4 / 25,5	2,7	3,0	3,4	3,7
27,0						2,4	2,7	3,1	3,4
28,0						2,1 / 27,5	2,4	2,8	3,1
29,0							2,1	2,5	2,8
30,0							1,9	2,3	2,6
32,0							1,4	1,8	2,1
34,0								1,4	1,7
36,0								1,0 / 35,5	1,4
38,0									1,1

Tab.-Nr.: 683R-75/1997/20.5/02.05 S2

Strangzahl / parts reeving	2	2	2	2	2	2	2	2	2
I	0%	50%	100%	100%	100%	100%	100%	100%	100%
II	0%	0%	0%	50%	100%	100%	100%	100%	100%
III	0%	0%	0%	0%	0%	50%	100%	100%	100%
IV	0%	0%	0%	0%	0%	0%	0%	50%	100%

Anmerkung:

- Die angegebenen Traglastwerte gelten für ebenen und festen Stand der Maschine.
- Traglastwerte sind in Tonnen angegeben und gelten für 360 Grad.
- Die Traglasten berücksichtigen die Normen DIN 15019/2 und ISO 4305
- Das Gewicht der Lastaufnahmemittel (Haken, Gehänge) ist von den Traglasten abzuziehen.
- Die Traglastwerte gelten für maximale Unterwagenpurbreite.
- Lastwerte müssen begrenzt oder vermindert werden, um ungünstige Bedingungen zu berücksichtigen, wie weichen oder unebenen Boden, schräge Gefälle, Wind, Seitenlasten, schwingende Lasten, Rucken oder plötzliches Stoppen der Ladungen, Unerfahrenheit des Personals, Fahren mit Last.
- Zulässiger Seilzug je Strang bei Kranbetrieb ist bei Seildurchmesser 20 mm - 7.200 kg
- Die angegebenen Traglastwerte sind nur zur Orientierung. Die jeweils gültigen Traglastwerte entnehmen Sie bitte den Tabellen in der Betriebsanleitung.

Alle Angaben vorläufig. Änderungen vorbehalten.

Kran-Traglasten Star-Lifter crane load chart Star-Lifter

Gegengewicht 25,9 t
Unterwagenballast 6 t

counterweight 25,9 t
carbody counterweight 6 t

Position 1

Ausladung Radius[m]	Auslegerlänge / boom length [m]								
	10,8	14,7	18,6	22,5	26,4	30,3	34,2	38,1	42,0
3,0	14,4								
3,5	14,4								
4,0	14,4	14,4							
5,0	14,4	14,4							
6,0	14,4	14,4	14,4						
7,0	14,4	14,4	14,4	14,4					
8,0	14,4	14,4	14,4	14,4	14,4				
9,0	14,4	14,4	14,4	14,4	14,4				
10,0	14,4 / 9,5	14,4	14,4	14,4	14,4	14,4			
11,0		14,4	14,4	14,4	14,4	14,4	13,2		
12,0		14,4	14,4	14,4	14,4	14,3	12,6	11,0	
13,0		14,4	14,4	14,4	14,4	13,8	13,2	11,9	10,8
14,0		13,2 / 13,5	12,8	13,0	12,7	12,2	11,3	10,4	9,0
15,0			11,4	11,5	11,7	11,3	10,7	10,0	8,9
16,0			10,1	10,3	10,4	10,5	10,1	9,6	8,7
17,0			9,0	9,2	9,3	9,7	9,6	9,1	8,4
18,0			8,1 / 17,5	8,3	8,4	8,8	9,0	8,7	8,1
19,0				7,4	7,6	7,9	8,2	8,2	7,8
20,0				6,7	6,8	7,2	7,5	7,8	7,4
21,0				6,1	6,2	6,5	6,8	7,2	7,0
22,0				5,5 / 21,5	5,6	6,0	6,2	6,6	6,6
23,0					5,1	5,4	5,7	6,1	6,4
24,0					4,6	4,9	5,2	5,6	5,9
25,0					4,2	4,5	4,8	5,2	5,5
26,0					3,8 / 25,5	4,1	4,4	4,8	5,1
27,0						3,7	4,0	4,4	4,7
28,0						3,3 / 27,5	3,6	4,0	4,4
29,0							3,3	3,7	4,0
30,0							3,0	3,4	3,7
32,0							2,5 / 31,5	2,9	3,2
34,0								2,4	2,7
36,0								1,9 / 35,5	2,3
38,0									2,0
40,0									1,7 / 39,5
Tab.-Nr.: 683R-75/2277/25.9/02.07 S1									
Strangzahl / parts reeving	2	2	2	2	2	2	2	2	2
I	0%	50%	100%	100%	100%	100%	100%	100%	100%
II	0%	0%	0%	50%	100%	100%	100%	100%	100%
III	0%	0%	0%	0%	0%	50%	100%	100%	100%
IV	0%	0%	0%	0%	0%	0%	0%	50%	100%

Schnabelausleger 14,4 t jib 14,4 t

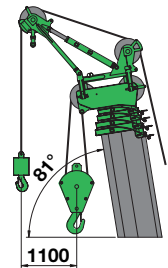
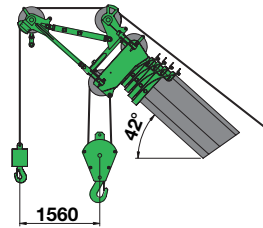

Position 1

Position 2

Position 2

Ausladung Radius[m]	Auslegerlänge / boom length [m]								
	10,8	14,7	18,6	22,5	26,4	30,3	34,2	38,1	42,0
3,0	14,4	14,4	14,4						
3,5	14,4	14,4	14,4						
4,0	14,4	14,4	14,4	14,4					
5,0	14,4	14,4	14,4	14,4					
6,0	14,4	14,4	14,4	14,4	14,4				
7,0	14,4	14,4	14,4	14,4	14,4	14,4			
8,0	14,4	14,4	14,4	14,4	14,4	14,4	14,0		
9,0	14,4	14,4	14,4	14,4	14,4	14,4	14,0	11,0	9,0
10,0	14,4 / 9,5	14,4	14,4	14,4	14,4	14,4	13,9	11,0	9,0
11,0		14,4	14,4	14,4	14,4	14,4	13,2	11,0	9,0
12,0		14,4	14,4	14,4	14,4	14,3	12,6	11,0	9,0
13,0		14,4	14,4	14,4	13,8	13,2	11,9	10,8	9,0
14,0		13,2 / 13,5	12,8	13,0	12,7	12,2	11,3	10,4	9,0
15,0			11,4	11,5	11,7	11,3	10,7	10,0	8,9
16,0			10,1	10,3	10,4	10,5	10,1	9,6	8,7
17,0			9,0	9,2	9,3	9,7	9,6	9,1	8,4
18,0			8,1 / 17,5	8,3	8,4	8,8	9,0	8,7	8,1
19,0				7,4	7,6	7,9	8,2	8,2	7,8
20,0				6,7	6,8	7,2	7,5	7,8	7,4
21,0				6,1	6,2	6,5	6,8	7,2	7,0
22,0				5,5 / 21,5	5,6	6,0	6,2	6,6	6,6
23,0					5,1	5,4	5,7	6,1	6,4
24,0					4,6	4,9	5,2	5,6	5,9
25,0					4,2	4,5	4,8	5,2	5,5
26,0					3,8 / 25,5	4,1	4,4	4,8	5,1
27,0						3,7	4,0	4,4	4,7
28,0						3,3	3,6	4,0	4,4
29,0							3,3	3,7	4,0
30,0							3,0	3,4	3,7
32,0							2,5 / 31,5	2,9	3,2
34,0								2,4	2,7
36,0								1,9 / 35,5	2,3
38,0									2,0
40,0									1,7 / 39,5
Tab.-Nr.: 683R-75/2277/25.9/02.07 S2									
Strangzahl / parts reeving	2	2	2	2	2	2	2	2	2
I	0%	50%	100%	100%	100%	100%	100%	100%	100%
II	0%	0%	0%	50%	100%	100%	100%	100%	100%
III	0%	0%	0%	0%	0%	50%	100%	100%	100%
IV	0%	0%	0%	0%	0%	0%	0%	50%	100%

Notes:

- The rated loads shown are based on the machine on firm level ground without travelling.
- The rated loads shown are in metric tons valid for 360 degrees swing.
- Liftcrane capacities are calculated to comply with DIN 15019/2 and ISO 4305
- The rated loads shown include the weight of all lifting attachments, such as hook and bucket.
- In operation crawler must be extended.
- The users must derate or limit the lifted loads to allow for adverse conditions such as soft or uneven ground, out of level conditions, wind, side loads, pendulum action, jerking or sudden stopping of loads, inexperience of personnel and travelling with a load.
- Max. single line pull for crane operation with rope diameter 20 mm - 7.200 kg
- The lifting capacities above are for reference only. For actual lifting capacities please refer to load chart in operator's manual.

All informations are subject to be changed without prior notice.

Hubarbeitsbühne - Arbeitsbereich

Access platform - working area

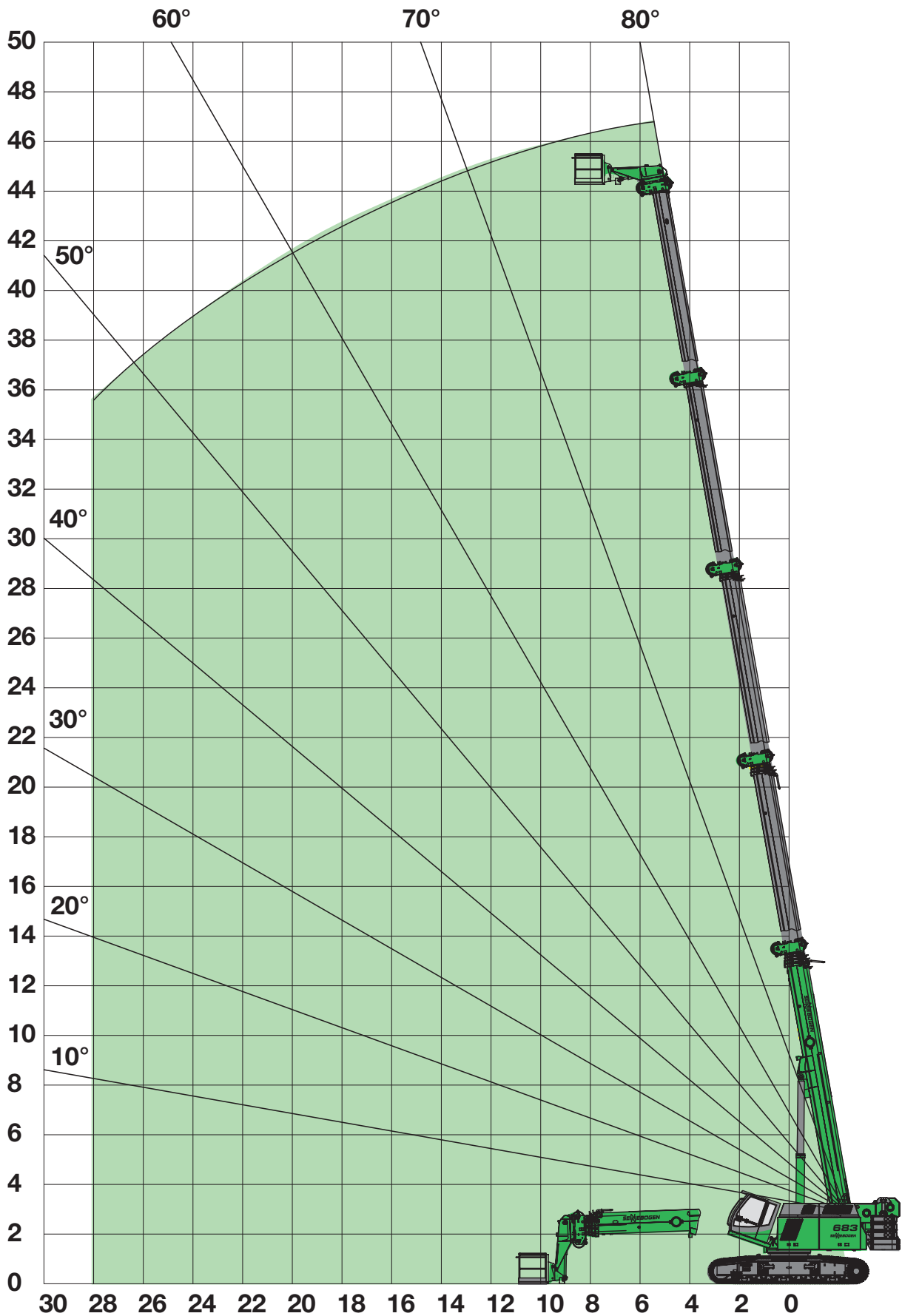

Transportmaße und Gewichte / transport dimensions and weights

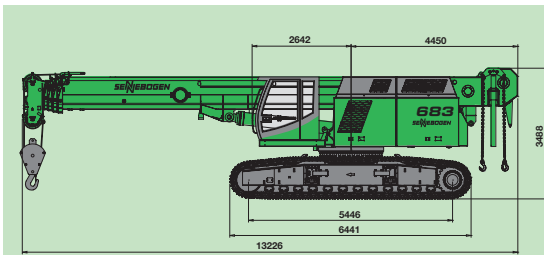

683 Grundmaschine mit Teleskopunterwagen Tele 83/390 und 700 mm 3-Steg Bodenplatten
683 basic machine with extendable undercarriage Tele 83/390 and 700 mm triple-bar-shoes

Gewicht / Weight kg 48.600 - 52.400

Transportbreite Grundmaschine - transport width of base machine
Bodenplatten/ width of tracks shoes 700 mm 800 mm 900 mm 1000 mm
Min.Transportbreite / min. transport width 3000 mm 3300 mm 3400 mm 3600 mm

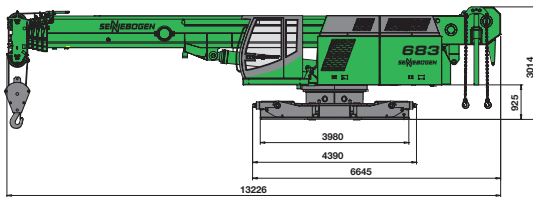

683 Grundmaschine mit Star-Lifter Unterwagen R87/440
683 basic machine with Star-Lifter undercarriage R87/440

Gewicht/ weight kg 32.400 - 36.200

Breite / width mm 3.000

Achtung: Die angegebenen Gewichte können sich durch verschiedene Ausstattungen ändern.

Note: The shown weights may vary with different equipment!

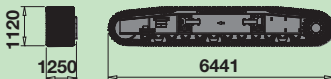

Raupenlaufwerk

Crawler

Gewicht: 9.300 - 10.500 kg (2x)
weight: 9.300 - 10.500 kg

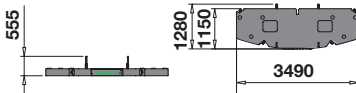

Ballastgrundplatte

Counterweight base plate

Gewicht: 5200 kg (1x)
weight: 5200 kg

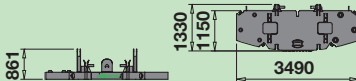

Ballastgrundplatte

Counterweight base plate

Gewicht: 5400 kg (1x)
weight: 5400 kg



Gegengewicht 10 Stück

Counterweight 10 pieces

Gewicht: 1500 kg (10x)
weight: 1500 kg (10x)

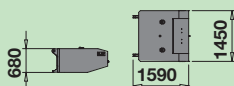

Unterwagenballast

Carbody Counterweight

Gewicht: 6500 kg / 3000kg (2x)
weight: 6500 kg / 3000kg

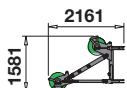

Schnabelausleger

auxiliary jib

Gewicht: 290 kg
weight: 290 kg

Breite: 650 mm
width: 650 mm

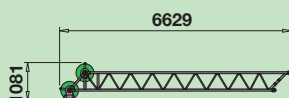

6m Verlängerung für Klappspitze

6m extension for jib

Gewicht: 400 kg
weight: 400 kg

Breite: 650 mm
width: 650 mm

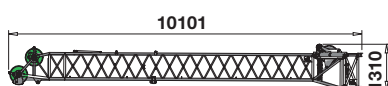

10m Klappspitze

10m jib

Gewicht: 1100 kg
weight: 1100 kg

Breite: 900 mm
width: 900 mm

Selbstmontagesystem self assembly system

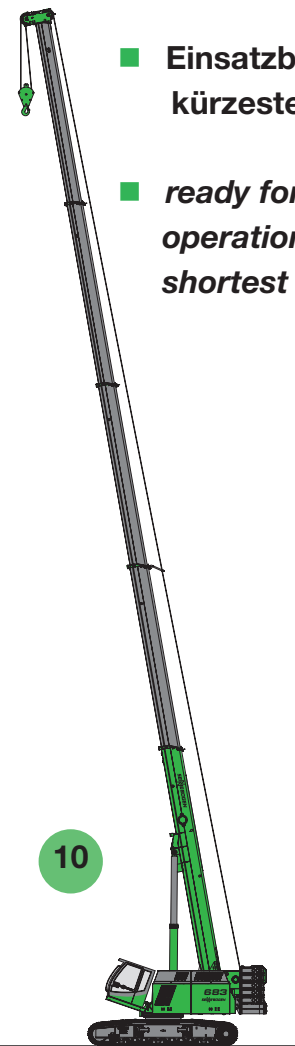
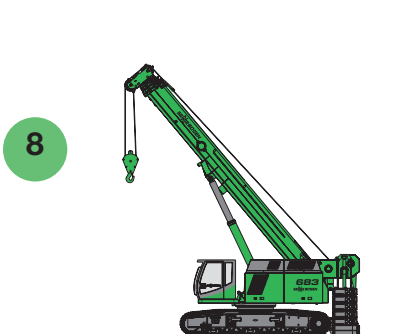
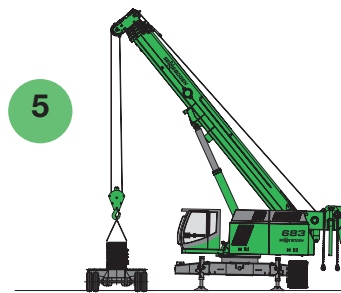
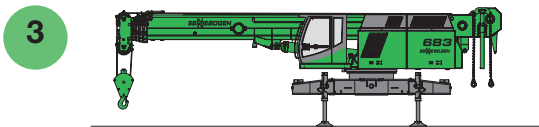
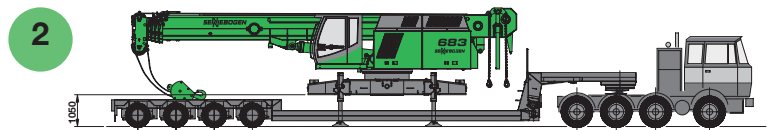

■ Einsatzbereit in
kürzester Zeit

■ ready for
operation in
shortest time



Notizen / Notes

A large grid of graph paper for taking notes, consisting of 20 columns and 30 rows of small squares.

Neue Großraum-Komfortkabine mit Schiebetür

New king-sized comfort cabin with sliding door

MAX CAB

Luftfederter Komfortsitz

mehrfach verstellbar mit Bandscheibenstütze und Sitzheizung, einstellbare Armlehnen

Air suspended comfort seat
adjustable with lumbar support and seat heating, adjustable armrests



Beste Ergonomie

Sitz ergonomisch komplett individuell zu den Steuerhebeln und separat zu den Fußpedalen einstellbar

Best ergonomics

Ergonomic operator's seat, individually adjustable in height and angle for optimum working environment and operator's comfort



Schiebetür

erleichtert sicheres und bequemes Ein- und Aussteigen

Sliding door

Simplified and safe access to the operator's cab



Hydraulisch neigbare Kabine

mit getöntem Sicherheitsglas, hydraulisch gedämpft und schwingungsgedämpft gelagert

Hydraulically tiltable cab

with safety glass tinted, hydraulically damped, resiliently mounted

Trittrost mit Geländer

serienmäßig = Sicherheit beim Auf- und Abstieg

Step with railing

Standard - safety in entering and exiting



SENNEBOGEN Diagnostic-System

zur Überwachung aller wichtigen Maschinen- und Motorfunktionen

SENNEBOGEN Diagnostic system

for monitoring of all essential machine and engine functions



Heiz-Klimaautomatik

mit Temperatursteuerung, 8 einstellbare Lüfterdüsen sorgen für wohliges Klima, starke Defrosterfunktion, Frischluft/ Umluftsteuerung mit Partikelfilter

Automatic regulation

of heating and air condition according to temperature setting, 8 adjustable air vents provide excellent defrosting, air/circulation function, particle filter for outside and circulation air

Vorsprung durch Innovation
Leading through Innovation

SENNEBOGEN Maschinenfabrik GmbH
Hebbelstrasse 30 · D-94315 Straubing
Tel: +49(0)94 21/5 40-144/145 Fax: 540-340
E-Mail: cranedivision@sennebogen.de

Technische Änderungen ohne Vorankündigung und Verpflichtung gegenüber früher gelieferten Geräten vorbehalten!
Die abgebildeten Geräte können Sonderausrüstungen haben! Irrtum und Druckfehler vorbehalten.
Technical specifications are subject to change without notice and without incurring responsibility for machines previously sold! The shown machines may have special equipment! Errors and misprints reserved.