

# KOMATSU®

## D65EX-17 D65PX-17 D65WX-17 Tier 4 Interim Engine

D  
65

### NET HORSEPOWER

205 HP @ 1950rpm  
153 kW @ 1950rpm

### OPERATING WEIGHT

DX65EX-17 20120 kg **44,355 lb**    DX65WX-17 20840 kg **45,945 lb**  
DX65PX-17 21470 kg **47,335 lb**



PHOTOS MAY INCLUDE OPTIONAL EQUIPMENT

D65-17

# WALK-AROUND

D65-17



Photos may include optional equipment

# D65-17

## Tier 4 Interim Engine

### NET HORSEPOWER

153 kW @ 1950 rpm  
205 HP @ 1950 rpm

### OPERATING WEIGHT

D65EX-17 20120 kg **44,355 lb**  
D65PX-17 21470 kg **47,335 lb**  
D65WX-17 20840 kg **45,945 lb**

### BLADE CAPACITY

**SIGMADOZER**  
D65EX-17 5.61 m<sup>3</sup> **7.34 yd<sup>3</sup>**  
D65WX-17 5.90 m<sup>3</sup> **7.72 yd<sup>3</sup>**

### Straight Tilt Dozer

D65EX-17 3.89 m<sup>3</sup> **5.09 yd<sup>3</sup>**  
D65PX-17 3.69 m<sup>3</sup> **4.83 yd<sup>3</sup>**

### Power Angle Tilt Dozer

D65EX-17 4.25 m<sup>3</sup> **5.56 yd<sup>3</sup>**  
D65PX-17 4.42 m<sup>3</sup> **5.78 yd<sup>3</sup>**  
D65WX-17 4.42 m<sup>3</sup> **5.78 yd<sup>3</sup>**



## OUTSTANDING PRODUCTIVITY & FUEL ECONOMY

**Innovative SIGMADOZER** reduces digging resistance and smoothly rolls material up for increased blade loads.

**Automatic transmission** with lockup torque converter improves fuel consumption.

Blade capacity:  
5.6 m<sup>3</sup> **7.3 yd<sup>3</sup>** (for EX)  
5.9 m<sup>3</sup> **7.7 yd<sup>3</sup>** (for WX)

**SAA6D114E-5 variable geometry turbocharged and aftercooled 8.85 liter diesel engine** provides excellent fuel economy. This engine is EPA Tier 4 Interim and EU Stage 3B emissions certified.

**Komatsu Variable Geometry Turbocharger (KVG T)** uses a hydraulic actuator to provide optimum air flow under all speed and load conditions.

**Komatsu Diesel Particulate Filter (KDPF)** captures 90% of particulate matter and provides automatic regeneration that does not interfere with daily operation.

**Rear hydraulics (standard)**

**Rear view monitoring system (standard)**

**Advanced diagnostic system** continuously monitors machine operation and vital systems to identify machine issues and assist with troubleshooting.

### Integrated ROPS cab features:

- Large, quiet, and pressurized cab
- Excellent visibility with integrated ROPS structure
- New heated air-ride seat with 15% higher capacity
- Interior noise level 75 dB(A)

**Parallel Link Undercarriage System (PLUS)** provides up to double the wear life and lower repair & maintenance costs.

**Hydrostatic Steering System (HSS)** provides smooth, quick, and powerful control in various ground conditions. (Counter-rotation is available when in neutral.)

**Self-adjusting idler** support provides constant and even idler tension, reducing vibrations and increasing undercarriage life.

**Power Angle Tilt (PAT)** dozer with manually adjustable blade pitch expands productivity in a variety of applications.

### Complete operator control

- Palm Command Control System (PCCS)
- Automatic/manual shift selectable mode
- Shift pattern preset function

**Extra-low machine profile** provides excellent machine balance and low center of gravity.

### Large color monitor

- Easy-to-read and use large 7" high-resolution multi-color monitor
- ECO guidance

**Enhanced provision for Topcon®** machine control (standard) Easy bolt-on finishing kit makes machine Topcon® plug-and-play.



## KOMTRAX®

Komtrax equipped machines can send location, SMR and operation maps to a secure website utilizing wireless technology. Machines also relay error codes, cautions, maintenance items, fuel levels, and much more.

# PRODUCTIVITY & ECOLOGY FEATURES

D65-17

## Environment-Friendly Engine

The Komatsu SAA6D114E-5 engine is EPA Tier 4 Interim and EU Stage 3B emissions certified and provides exceptional performance while reducing fuel consumption. Based on Komatsu proprietary technologies developed over many years, this new diesel engine reduces exhaust gas particulate matter (PM) by more than 90% and nitrogen oxide (NOx) by more than 45%, compared to Tier 3 levels. Through the in-house development and production of engines, electronics, and hydraulic components, Komatsu has achieved great advancements in technology providing high levels of performance and efficiency in virtually all applications.

## Komatsu Variable Geometry Turbocharger (KVGT)

Using Komatsu proprietary technology, a newly designed variable geometry turbocharger with a hydraulic actuator is used to manage and deliver optimum air flow to the combustion chamber under all speed and load conditions. The robust hydraulic actuator provides power and precision, resulting in cleaner exhaust gas and improved fuel economy while maintaining performance.

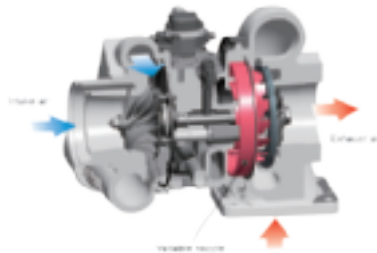

## Advanced Electronic Control System

The engine control system has been upgraded to effectively manage a variety of parameters such as the air flow rate, EGR gas flow rate, fuel injection parameters, and aftertreatment functions. The new control system also provides enhanced diagnostic capabilities.

## Cooled Exhaust Gas Recirculation (EGR)

Cooled EGR, a technology that has been well proven in Komatsu Tier 3 engines, reduces NOx emission to meet Tier 4 levels. The hydraulically-actuated EGR system has increased capacity and uses larger and more robust components to ensure reliability for demanding work conditions.

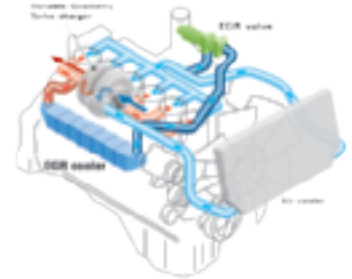

## Redesigned combustion chamber

The combustion chamber has a new shape designed to improve combustion and further reduce NOx, PM, fuel consumption, and noise levels.

## Closed Crankcase Ventilation (CCV)

Crankcase emissions (blow-by gas) are passed through a CCV filter. The CCV filter traps oil mist which is returned back to the crankcase while the filtered gas is returned to the air intake.



## High efficiency fuel filter

A new high efficiency fuel filter improves fuel system reliability. The dual-type filter offers twice the filtration capacity.

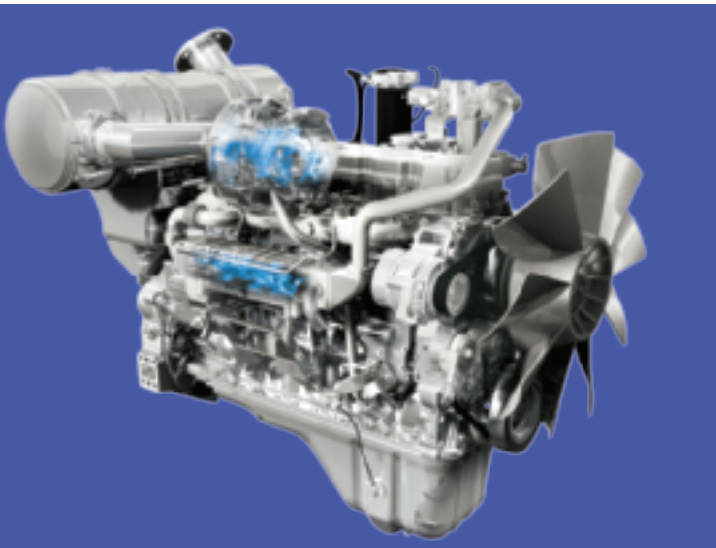

## WORKING ENVIRONMENT

### Komatsu Diesel Particulate Filter (KDPF)

Komatsu has developed a high efficiency diesel particulate filter that captures more than 90% of particulate matter. Both passive and active regeneration are automatically initiated by the engine controller depending on the soot level of the KDPF. A special oxidation catalyst with a fuel injection system is used to oxidize and remove particulate matter while the machine is running so the regeneration process will not interfere with daily operation. The operator can also initiate regeneration manually or disable regeneration depending on the work environment.

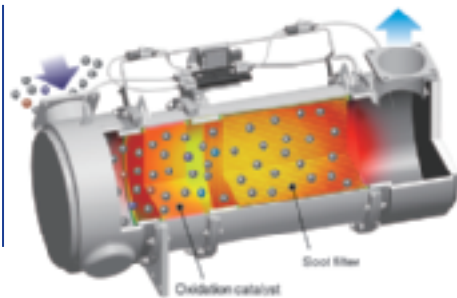

### KDPF Regeneration Notification

The LCD color monitor panel provides the operator with the status of the KDPF regeneration without interfering with daily operation. When the machine initiates active regeneration, an icon will notify the operator.



### Selectable Working Mode

Working mode E is for general dozing applications with adequate speed and power while reducing fuel consumption and CO<sub>2</sub>. Working mode P is aimed at powerful operation and maximum production. The working mode is easily switched on the monitor panel, depending on the work at hand.



### Manual Stationary Regeneration

Under most conditions, active regeneration will occur automatically with no effect on machine operation. In case the operator needs to disable active regeneration or initiate a manual stationary regeneration, such as in high-combustible applications, this can be easily accomplished through the monitor panel. The soot level indicator identifies how much soot is trapped in the KDPF.



#### ■ E mode (Economy mode)

With E mode, the engine outputs enough power for most general dozing applications without delivering unnecessary power. This mode allows for energy-saving operation and is suitable for work on ground where the machine may experience shoe slip or applications not requiring large power such as downhill dozing, leveling and light-load work.

#### ■ P mode (Power mode)

With P mode, the engine outputs its full power, allowing the machine to perform large production, heavy-load, or uphill work.

## Outstanding Productivity

### SIGMADOZER – The Next Generation Blade

Based on a completely new digging theory, SIGMADOZER dramatically improves dozing performance and increases productivity. A new frontal design concept adopted for digging and rolling material up at the center of the blade increases soil holding capacity while simultaneously reducing side spillage. It also reduces digging resistance, producing a smoother flow of earth, enabling the dozing of larger quantities of soil with less power.



SIGMADOZER (D65-17)



Semi-U blade (D65-15)

**Production Increased By 15%** (compared with a conventional Semi-U blade model)

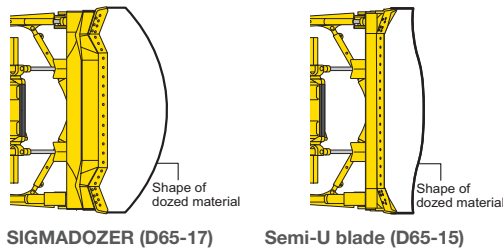

## Outstanding Fuel Economy

### Automatic Transmission with Lockup Torque Converter

A significant reduction in fuel consumption and greater power train efficiency are achieved by the new automatic transmission and lockup torque converter. The automatic transmission selects the optimal gear range depending on the working conditions and load placed on the machine. This means the machine is always operating at maximum efficiency.

The lockup mechanism of the torque converter is automatically actuated to transfer engine power directly to the transmission in travelling and usual dozing speed ranges. Locking up the torque converter results in 10% improved drive train efficiency. Because the electronically controlled Tier 4 Interim engine is extremely efficient, an additional 5% decrease in fuel consumption is realized while also maintaining machine power.

**Fuel Consumption Decreased By 15%** (compared with a conventional model)

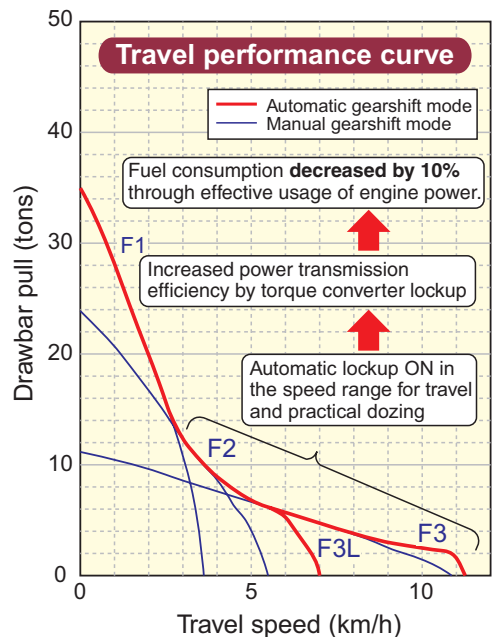
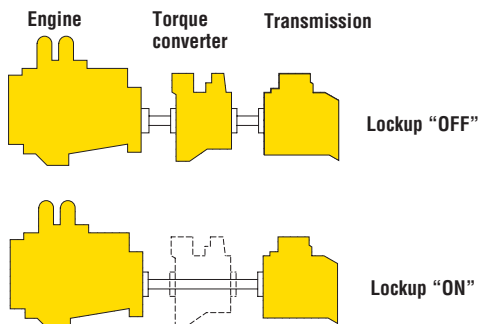

# WORKING ENVIRONMENT

## Other Features

### Power Angle Tilt (PAT) Dozer

A Power Angle Tilt dozer blade with highly durable box-structure frame is available for the EX, WX and PX machines. The hydraulic blade tilt and angling functions and manually adjustable blade pitch expand versatility and productivity in a variety of applications. This PAT dozer assembly is tested to the same stringent test standards as Komatsu's outside mounted blades.



### Secondary Engine Shutdown Switch

A new secondary switch has been added, at the side of the front console, to shut down the engine.



### New Shovel Holder

A convenient shovel holder is now standard. The holder is lockable and adjustable for many shovel types.



### ECO Guidance

In order to support to optimum operation, the following 5 recommendations are displayed to improve fuel saving operation:

- 1) Avoid Excessive Engine Idling
- 2) Use Economy Mode to Save Fuel
- 3) Avoid Hydraulic Relief Pressure
- 4) Avoid Overload
- 5) Use Automatic Shift Mode

The operator can access the ECO guidance menu to check the Operation Records, Eco Guidance Records, and Average Fuel Consumption logs.

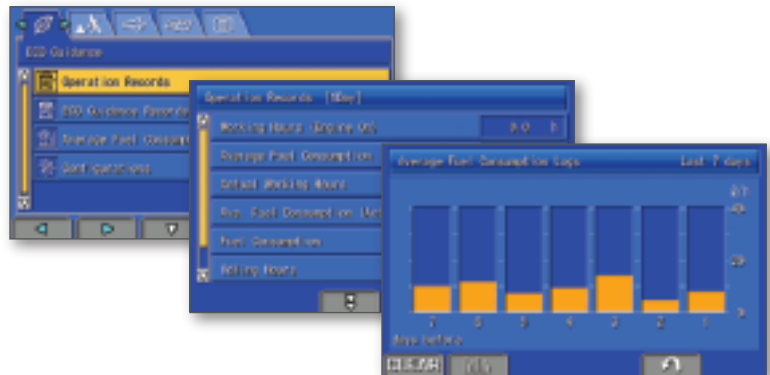
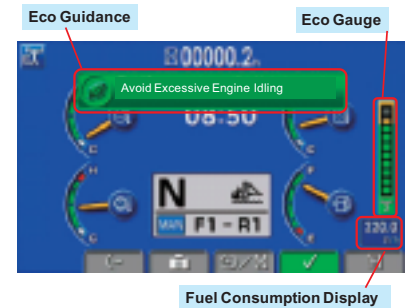

### Rear View Monitoring System

On the large LCD color monitor, the operator can view, through one camera, areas directly behind the machine. This camera can be synchronized with reverse operation.



# COMPLETE OPERATOR CONTROL

## Human-Machine Interface

### Palm Command Control System (PCCS) Travel Joystick

Palm command travel joystick provides the operator with a relaxed posture and superb fine control. Transmission shifting is simplified with thumb push buttons.

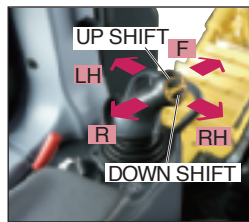

### Palm Command Proportional Pressure Control (PPC) Blade Control Joystick

Blade control joystick uses the PPC valve and joystick, similar to the travel control joystick. PPC control combined with the highly reliable Komatsu hydraulic system enables superb fine control. A switch is now used to angle the PAT blade.



## Power Train Electronic Control System

### Automatic/Manual Shift Selectable Mode

Automatic or manual shift modes can be selected with ease to suit the work at hand by simply pressing the switch on the multi-monitor (selection at neutral).

#### Automatic shift mode

Select for all general dozing. When a load is applied, the transmission automatically shifts down, and when the load is off, it automatically shifts up to a set maximum gear speed. This mode economizes both fuel and production further when the torque converter lockup mechanism is actuated according to load, providing a one-to-one drive.



### Shift Pattern Preset Function

When the shift pattern is set to either <F1-R2>, <F2-R1>, <F2-R2>, <F2-R3L> or <F3L-R3L> in the automatic mode, the transmission automatically shifts to the preset gear when the travel control joystick is set to Forward or Reverse position, reducing work cycle time and operator effort. Shift patterns <F2-R3L> and <F3L-R3L> are newly added for high-speed leveling operation.

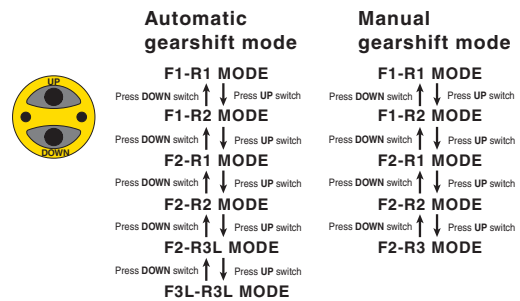

#### Manual shift mode

Select for dozing and ripping rough ground. When loaded, the transmission automatically shifts down, but does not shift up when the load is off.



### Electronic Controlled Modulation Valve (ECMV) Transmission

A controller automatically adjusts each clutch engagement depending on travel conditions, providing smooth shockless clutch engagement, improved component life and operator ride comfort.

### Hydrostatic Steering System (HSS) – Smooth, Powerful Turning

The engine power is transmitted to both tracks without power interruption on the inside track for smooth, powerful turns. Counter-rotation is available in neutral for minimum turning radius, enhancing maneuverability.



# WORKING ENVIRONMENT

## Newly Integrated ROPS Cab

A newly designed cab; wider, deeper and taller, is integrated with the ROPS. High rigidity and superb sealing performance greatly reduce noise and vibration for the operator and minimize dust entering the cab. The standard air-ride seat positions the operator 3" higher and 4" closer to the blade. The taller and narrower battery box and tanks plus larger glass area also improve visibility of the blade, sides, and rear of the machine. Cab meets OSHA/MSHA ROPS and FOPS Level 2 standards.



Photos may include optional equipment

## Large Multi-Lingual LCD Color Monitor

A large user-friendly color monitor enables accurate and smooth work. Excellent screen visibility is achieved by the use of a TFT liquid crystal display that can easily be read at various angles and lighting conditions. Simple and easy to operate switches. Function keys facilitate multi-function operations. Data can be displayed in 25 languages for local customization.



## Comfortable Ride with Cab Damper Mounting

The D65's cab mount uses a cab damper which provides excellent shock and vibration absorption capacity. The long stroke cab damper mounts soften shocks and vibration while traveling over adverse conditions, which conventional rubber mounting systems are unable to match. The cab damper spring isolates the cab from the machine body, suppressing vibration and providing a quiet, comfortable operating environment. Interior noise level is 75 dB(A).

## New Air Suspension Seat

A new higher capacity low-back heated seat with headrest and 12.5° swivel is now standard.



## Auxiliary Input Jack

By connecting an auxiliary device to this plug input, the operator can hear sound through the speakers installed in the cab.



# MAINTENANCE AND RELIABILITY FEATURES

## Multi-monitor with Troubleshooting Function to Help Prevent Critical Machine Trouble

Various meters, gauges and warning functions are centrally arranged on the multi-monitor. The monitor simplifies start-up inspection and promptly warns the operator with a lamp and buzzer if any abnormalities should occur. In addition, countermeasures are indicated in 4 levels to help prevent major problems. Replacement times for oil and filters are also indicated.



## Gull-wing Engine Side Covers

The engine side covers are gull-wing type with a gas spring, and the opening angle of the cover is further increased to facilitate engine maintenance and filter replacement.

## Maintenance Function

When the machine reaches the replacement interval for oil and filters, the monitor panel will display lights to inform the operator.



## Parallel Link Undercarriage System (PLUS)

Komatsu's innovative Parallel Link Undercarriage System features a rotary bushing that demonstrates high durability in any working conditions. Allowing the bushing to rotate virtually eliminates bushing wear, resulting in doubled service life of the undercarriage when compared with the conventional undercarriage. In addition, wear limits of the link and carrier roller are increased to balance with the extended service life of the bushing.

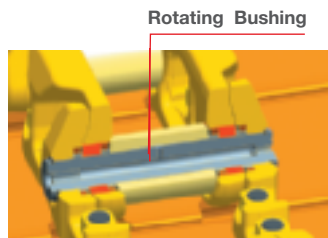

## Oil Pressure Check Ports

Pressure check ports for power train components are centralized to promote quick and simple diagnosis.

## Wide Core Cooling System

In addition to improved engine compartment sealing, a new wide core cooling system is standard. Radiator, oil cooler and charge air cooler use large square-wave fins spaced at 6 fins per inch. This allows more material to pass through, which helps self-cleaning and reduces maintenance.

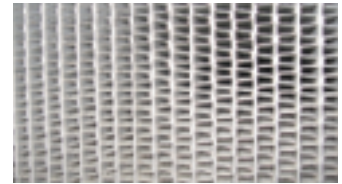

## Battery Disconnect Switch

A standard battery disconnect switch allows a technician to disconnect the power supply before servicing the machine.



## Self-adjusting Idler Support

Self-adjusting idler support applies a constant spring force to the wear plate of the idler guide to eliminate the play of the idler. This results in reduced noise and vibration as well as extended service life of the wear plate.

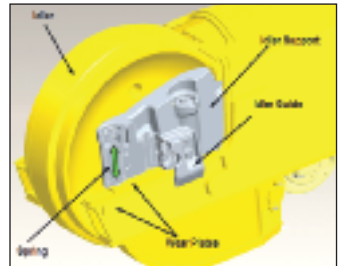

## Robust Guarding Package

Komatsu offers a full cab, tanks, and hood guarding package that was designed using extensive customer feedback. This lowers operating costs by minimizing machine damage.



## KOMTRAX EQUIPMENT WORKING ENVIRONMENT MONITORING



**KOMTRAX is Komatsu's remote equipment monitoring and management system.** KOMTRAX gathers critical machine and operation information and provides it in a user-friendly format so that you can make well-informed decisions. KOMTRAX gives you more control of your equipment and better control of your business!

KOMTRAX comes standard on all new Komatsu machines with complimentary manufacturer communications services throughout the entire ownership period. It is a powerful tool and makes Komatsu machines an even better purchase!

### Fleet Optimization

KOMTRAX tells you how your machines and operators are performing. KOMTRAX provides:

- Fuel consumption data and trends, by unit or fleet
- Machine fuel level
- Machine utilization
- Actual working hours/Machine idle hours
- Attachment usage hours
- Machine travel hours
- Machine load analysis
- Operating mode ratios

### Location and Asset Management

KOMTRAX tells you where your machines are and can help prevent unauthorized use. KOMTRAX provides:

- GPS location/Operation maps
- Out-of-area and movement alert with location and time
- Engine, nighttime, and calendar lock

### Maintenance Management

KOMTRAX monitors the health of your machines and provides critical information so that you, and your distributor, can take proactive maintenance measures and reduce downtime. KOMTRAX provides:

- Service Meter Reading (SMR)
- Cautions/Abnormality codes
- Maintenance replacement notifications

### Easy and Flexible Access to Information

With KOMTRAX, information about your machines is available through a convenient, internet-based portal. KOMTRAX provides:

- A user-friendly KOMTRAX website that provides customized access to your machine information
- E-mail and text alerts
- Web dial-up service
- Monthly fleet summary reports

For more information, including terms and conditions of the manufacturer complimentary KOMTRAX communication service, ask your distributor, pick up a KOMTRAX brochure, or go to [www.komatsuamerica.com/komtrax](http://www.komatsuamerica.com/komtrax).

## KOMTRAX®

For construction and compact equipment.

## KOMTRAX Plus

For production and mining class machines.

# KOMATSU PARTS & SERVICE SUPPORT



Komatsu is an industry leader in building reliable and technologically advanced machines. It is only fitting that we would provide superior Product Support. Komatsu and its distributors are focused on providing their customers unparalleled Product Support throughout the entire lifecycle of the machine. It's called Komatsu CARE.

## Komatsu CARE – Complimentary Scheduled Maintenance

Komatsu remains focused on lowering the customer's ownership costs by engineering machines with increased fuel efficiency and productivity. In addition, one Komatsu CARE program aimed at further reducing your owning and operating costs is Complimentary Scheduled Maintenance. Komatsu machine owners can now rely on their Komatsu Distributor to perform the preventative maintenance on their Komatsu Tier 4 machines.

- Complimentary scheduled maintenance for the earlier of 3 years or 2,000 hours is standard on all Komatsu Tier 4 construction machines and is available at all distributors in the U.S. and Canada.
- Service is performed by factory certified technicians using only Komatsu Genuine parts and fluids
- Significantly lowers your cost of ownership while maintaining high equipment uptime and reliability
- Increases resale value and provides detailed maintenance records

## Komatsu CARE – Extended Coverage

Komatsu equipment is built to withstand harsh operating environments, but our Extended Coverage can provide further peace of mind by protecting customers from unplanned expenses and impacts in cash flow. Purchasing Komatsu CARE's Extended Coverage locks-in the cost of covered parts and labor for the extended warranty period and helps to turn these variable expenses into a fixed cost.

- No Stop Loss or Loss Limits imposed, regardless of the coverage type or repair expense
- Any combination of months and hours out to five years and 10,000 engine hours – KOWA kits included
- Coverage premium can be rolled into the machine financing at time of sale or purchased any time before the expiration of the machine's standard warranty
- Coverage is fully transferable and honored by all Komatsu distributors throughout the U.S. and Canada

## Komatsu CARE – Total CARE

Total CARE combines the benefits of the Komatsu CARE Scheduled Maintenance and Extended Coverage programs on your Tier 4 machine. This ensures the use of Komatsu genuine parts and fluids during regular maintenance intervals as well as highly skilled and efficient technicians to perform any other warranty repair work that might be necessary to keep your Komatsu equipment running like new.



## Komatsu Parts Support

Because downtime can be costly, Komatsu maintains a strategic distribution network throughout the U.S. and Canada, to ensure superior parts availability and to keep your Komatsu machine up and running.

- Komatsu America has nine Parts Distribution Centers strategically located throughout the U.S. and Canada
- Komatsu America's Parts distribution network is accessible 24/7/365 to fulfill your parts needs
- Komatsu has a distributor network of over 325 locations across the U.S. and Canada
- Online parts ordering available through Komatsu eParts, 24/7/365. (See distributor for details)
- Komatsu offers a full line of factory Remanufactured products with same-as-new warranties at a significant cost reduction:
  1. Complete Engine Assemblies
  2. Transmissions
  3. Torque Converters
  4. Hydraulic components
  5. Starters, Alternators, turbochargers and circuit boards

## Komatsu Oil and Wear Analysis (KOWA)

The KOWA program uses independent laboratories across the United States to determine how your machine is performing based on a small sample of oil or other fluid. Just like a doctor will take a blood test to check on your personal health, KOWA allows you to check how your equipment is performing. Used with PM Clinic and PM Tune Up, KOWA is one of your best tools for proactively maintaining your Komatsu equipment and maximizing its availability and performance.

KOWA detects fuel dilution and coolant leaks, identifies contaminants, and measures wear-metals. Your distributor will help you interpret this information so you can identify potential problems and head them off before they lead to major repairs.

For more information of all of the manufacturer sponsored programs mentioned in this brochure, including terms and conditions of the individual programs, please speak with your distributor or go to [www.komatsuamerica.com](http://www.komatsuamerica.com)

## SPECIFICATIONS



### ENGINE

Model.....Komatsu SAA6D114E-5\*  
 Type..... 4-cycle, water-cooled, direct injection  
 Aspiration..... Komatsu variable geometry turbocharged, air-to-air aftercooled  
 Number of cylinders..... 6  
 Bore x stroke..... 114 mm x 144.5 mm **4.49" x 5.69"**  
 Piston displacement.....8.85 ltr **540 in<sup>3</sup>**  
 Governor.....All-speed and mid-range, electronic  
 Horsepower  
 SAE J1995.....Gross 155 kW **207 HP**  
 ISO 9249 / SAE J1349..... Net 153 kW **205 HP**  
 Rated rpm..... 1950 rpm  
 Fan drive type .....Hydraulic  
 Lubrication system  
 Method..... Gear pump, force lubrication  
 Filter..... Full-flow  
 \*EPA Tier 4 Interim and EU stage 3B emissions certified



### TORQFLOW TRANSMISSION

Komatsu TORQFLOW transmission consists of a water-cooled, 3-element, 1-stage, 2-phase, torque converter with lockup clutch, and a planetary gear, multiple-disc clutch transmission which is electronically controlled, hydraulically actuated and force-lubricated for optimum heat dissipation. Shift lock lever and neutral safety switch.

Travel speed	Forward	Reverse
<b>1st</b>	3.6 km/h <b>2.2 mph</b>	4.4 km/h <b>2.7 mph</b>
<b>2nd</b>	5.5 km/h <b>3.4 mph</b>	6.6 km/h <b>4.1 mph</b>
<b>3rd L</b>	7.2 km/h <b>4.5 mph</b>	8.6 km/h <b>5.3 mph</b>
<b>3rd</b>	11.2 km/h <b>7.0 mph</b>	13.4 km/h <b>8.3 mph</b>

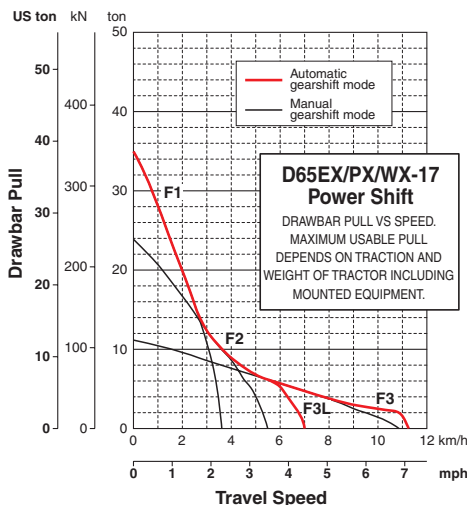

### STEERING SYSTEM

Palm Command Control System (PCCS) lever controls for all directional movements. Pushing the PCCS lever forward results in forward machine travel, while pulling it rearward reverses the machine. Simply tilt the PCCS lever to left to make a left turn. Tilt it to the right for a right turn.

Hydrostatic Steering System (HSS) is powered by steering planetary units and a hydraulic pump and motor. Counter-rotation turns are also available. Wet, multiple-disc, pedal-controlled service brakes are spring-actuated and hydraulically released. Gear shift lock lever also applies parking brake.

Minimum turning radius	
D65EX-17 .....	1.9 m <b>6'3"</b>
D65EX-17 with PAT .....	2.0 m <b>6'7"</b>
D65PX-17 .....	2.2 m <b>7'3"</b>
D65WX-17 .....	2.1 m <b>6'11"</b>



### UNDERCARRIAGE

Suspension..... Oscillating equalizer bar and pivot shaft  
 Track roller frame ..... Monocoque, large section, durable construction

Rollers and idlers ..... Lubricated

Track shoes

Parallel Link Undercarriage System (PLUS) with lubricated rotating bushings for extended system wear life and lower maintenance costs. Track tension is easily adjusted with grease gun.

#### Tractor for outside mounted blade (Straight Tilt, SIGMADOZER)\*

	D65EX-17	D65PX-17	D65WX-17
Number of track rollers (each side)	7	8	7
Type of shoes (standard)	Single grouser	Single grouser	Single grouser
Number of shoes (each side)	42	45	42
Grouser height	mm in 65 <b>2.6"</b>	65 <b>2.6"</b>	65 <b>2.6"</b>
Shoe width (standard)	mm in 610 <b>24"</b>	915 <b>36"</b>	760 <b>30"</b>
Ground contact area	cm <sup>2</sup> 36234	59935	45145
	in <sup>2</sup> <b>5,616</b>	<b>9,290</b>	<b>6,997</b>
Ground pressure (tractor)	kPa 48.0	31.7	39.8
	kgf/cm <sup>2</sup> 0.49	0.32	0.41
	psi <b>6.96</b>	<b>4.60</b>	<b>5.78</b>
Track gauge	mm ft.in 1880 <b>6'2"</b>	2050 <b>6'9"</b>	2050 <b>6'9"</b>
Length of track on ground	mm ft.in 2970 <b>9'9"</b>	3275 <b>10'9"</b>	2970 <b>9'9"</b>

#### Tractor for inside mounted blade (PAT)\*

	D65EX-17	D65PX-17	D65WX-17
Number of track rollers (each side)	7	8	7
Type of shoes (standard)	Single grouser	Single grouser	Single grouser
Number of shoes (each side)	42	45	42
Grouser height	mm in 65 <b>2.6"</b>	65 <b>2.6"</b>	65 <b>2.6"</b>
Shoe width (standard)	mm in 560 <b>22"</b>	760 <b>30"</b>	760 <b>30"</b>
Ground contact area	cm <sup>2</sup> 33265	49780	45145
	in <sup>2</sup> <b>5,156</b>	<b>7,716</b>	<b>6,997</b>
Ground pressure (tractor)	kPa 54.6	38.2	42.1
	kgf/cm <sup>2</sup> 0.56	0.39	0.43
	psi <b>7.91</b>	<b>5.54</b>	<b>6.11</b>
Track gauge	mm ft.in 2050 <b>6'9"</b>	2230 <b>7'4"</b>	2230 <b>7'4"</b>
Length of track on ground	mm ft.in 2970 <b>9'9"</b>	3275 <b>10'9"</b>	2970 <b>9'9"</b>

\*See page 12 for tractor/blade combinations.



## FINAL DRIVES

Double-reduction final drive of spur and planetary gear sets to increase tractive effort and reduce gear tooth stresses for long final drive life. Segmented sprocket teeth are bolt-on for easy replacement.



## HYDRAULIC SYSTEM

Closed-center load sensing system (CLSS) designed for precise and responsive control, and for efficient simultaneous operation.

Hydraulic control units:

All spool valves externally mounted beside the hydraulic tank. Piston type hydraulic pump with capacity (discharge flow) of 248 ltr/min **65.5 U.S. gal/min** at rated engine rpm.

Relief valve setting ..... 27.9 MPa 285 kg/cm<sup>2</sup> **4,050 psi**

Control valves:

Spool control valves for SIGMADOZER or straight tilt dozer

- Positions: Blade lift ..... Raise, hold, lower, and float
- Blade tilt ..... Right, hold, and left
- Rear attachment.....Raise, hold, and lower



## SERVICE REFILL CAPACITIES

Fuel tank .....	415 ltr	<b>109.6 U.S. gal</b>
Coolant .....	54 ltr	<b>14.3 U.S. gal</b>
Engine.....	25 ltr	<b>6.6 U.S. gal</b>
Torque converter, transmission, bevel gear, and steering system .....	48 ltr	<b>12.7 U.S. gal</b>
Final drive (each side)		
D65EX-17 .....	16.5 ltr	<b>4.4 U.S. gal</b>
D65EX-17 with PAT .....	16.5 ltr	<b>4.4 U.S. gal</b>
D65PX-17 .....	22 ltr	<b>5.8 U.S. gal</b>
D65WX-17 .....	22 ltr	<b>5.8 U.S. gal</b>

Spool control valves for Power Angle Tilt dozer

- Positions: Blade lift ..... Raise, hold, lower, and float
- Blade tilt ..... Right, hold, and left
- Blade angle ..... Right, hold, and left
- Rear attachment.....Raise, hold, and lower

Hydraulic cylinders.....Double-acting, piston

	Number of cylinders	Bore	
		SIGMADOZER Straight Tilt Dozer	Power Angle Power Tilt Dozer
Blade lift	2	85 mm <b>3.3"</b>	90 mm <b>3.5"</b>
Blade tilt	1	125 mm <b>4.9"</b>	130 mm <b>5.1"</b>
Blade angle	2	N/A	110 mm <b>4.3"</b>
Ripper lift	1	125 mm <b>4.9"</b>	125 mm <b>4.9"</b>
Pitch angle	1	39° - 53°	52° - 58°

Hydraulic oil capacity (refill):..... 55 ltr **14.5 U.S. gal**

Ripper equipment (additional volume):

Multi-shank ripper ..... 7 ltr **1.8 U.S. gal**



## DOZER EQUIPMENT

Blade capacities are based on the SAE recommended practice J1265.

Use of high tensile strength steel in moldboard for strengthened blade construction.

	Overall Length With Dozer mm ft.in	Blade Capacity m <sup>3</sup> yd <sup>3</sup>	Blade Width x Height mm ft.in	Max. Lift Above Ground mm ft.in	Max. Drop Below Ground mm ft.in	Max. Tilt Adjustment mm ft.in	Weight Dozer equipment kg lb	Ground Pressure* kPa kg/cm <sup>2</sup> psi
<b>D65EX-17</b> SIGMADOZER	5490 <b>18'0"</b>	5.61 <b>7.34</b>	3410 x 1425 <b>11'2" x 4'8"</b>	1135 <b>3'9"</b>	500 <b>1'8"</b>	870 <b>2'10"</b>	2390 <b>5,260</b>	54.5/0.56/ <b>7.90</b>
<b>D65EX-17</b> Straight Tilt Dozer	5330 <b>17'6"</b>	3.89 <b>5.09</b>	3415 x 1225 <b>11'2" x 4'0"</b>	1105 <b>3'8"</b>	430 <b>1'5"</b>	870 <b>2'10"</b>	2060 <b>4,540</b>	53.6/0.55/ <b>7.77</b>
<b>D65EX-17</b> Power Angle Tilt Dozer	5790 <b>19'0"</b>	4.25 <b>5.56</b>	3870 x 1235 <b>12'8" x 4'1"</b>	1170 <b>3'10"</b>	695 <b>2'3"</b>	500 <b>1'8"</b>	2960 <b>6,530</b>	63.3/0.65/ <b>9.18</b>
<b>D65PX-17</b> Straight Tilt Dozer	5680 <b>18'8"</b>	3.69 <b>4.83</b>	3970 x 1100 <b>13'0" x 3'7"</b>	1130 <b>3'8"</b>	535 <b>1'9"</b>	890 <b>2'11"</b>	2100 <b>4,630</b>	35.1/0.36/ <b>5.10</b>
<b>D65PX-17</b> Power Angle Tilt Dozer	5790 <b>19'0"</b>	4.42 <b>5.78</b>	4010 x 1235 <b>13'2" x 4'1"</b>	1170 <b>3'10"</b>	695 <b>2'3"</b>	520 <b>1'8"</b>	2990 <b>6,590</b>	44.1/0.45/ <b>6.39</b>
<b>D65WX-17</b> SIGMADOZER	5500 <b>18'1"</b>	5.90 <b>7.72</b>	3580 x 1425 <b>11'9" x 4'8"</b>	1135 <b>3'9"</b>	500 <b>1'8"</b>	770 <b>2'6"</b>	2500 <b>5,510</b>	45.3/0.46/ <b>6.57</b>
<b>D65WX-17</b> Power Angle Tilt Dozer	5790 <b>19'0"</b>	4.42 <b>5.78</b>	4010 x 1235 <b>13'2" x 4'1"</b>	1170 <b>3'10"</b>	695 <b>2'3"</b>	520 <b>1'8"</b>	2990 <b>6,590</b>	48.6/0.50/ <b>7.05</b>

\*Ground pressure shows tractor, ROPS cab, operator, standard equipment and applicable blade (EX, WX, PAT with counterweight).

## WORKING ENVIRONMENT



### DIMENSIONS — OUTSIDE MOUNTED DOZER BLADE

	D65EX-17 SIGMADOZER	D65PX-17 Straight Tilt Dozer	D65WX-17 SIGMADOZER
A	5490 mm <b>18'0"</b>	5680 mm <b>18'8"</b>	5500 mm <b>18'1"</b>
B	1880 mm <b>6'2"</b>	2050 mm <b>6'9"</b>	2050 mm <b>6'9"</b>
C	3370 mm <b>11'1"*</b>	3370 mm <b>11'1"*</b>	3370 mm <b>11'1"*</b>
D	3085 mm <b>10'1"</b>	3085 mm <b>10'1"</b>	3085 mm <b>10'1"</b>
E	2970 mm <b>9'9"</b>	3275 mm <b>10'9"</b>	2970 mm <b>9'9"</b>
F	610 mm <b>24"</b>	915 mm <b>36"</b>	760 mm <b>30"</b>
G	65 mm <b>2.6"</b>	65 mm <b>2.6"</b>	65 mm <b>2.6"</b>

\*3338 mm **10'11"** is overall height if Komatsu sweeps are installed.

Ground clearance ..... 415 mm **1'4"**

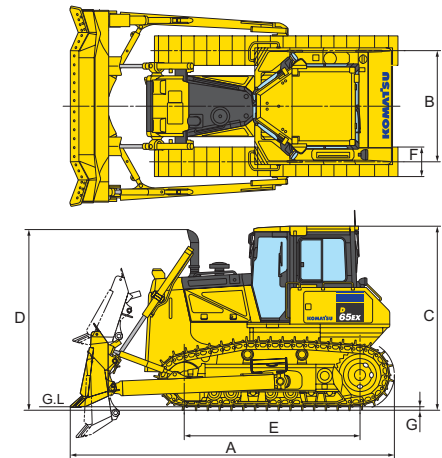
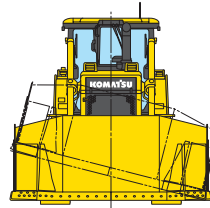

Shown with SIGMADOZER (D65EX-17) single grouser shoe.



### DIMENSIONS — PAT DOZER BLADE

	D65EX-17 PAT Dozer	D65PX-17 PAT Dozer	D65WX-17 PAT Dozer
A	5790 mm <b>19'0"</b>	5790 mm <b>19'0"</b>	5790 mm <b>19'0"</b>
B	2050 mm <b>6'9"</b>	2230 mm <b>7'4"</b>	2230 mm <b>7'4"</b>
C	3370 mm <b>11'1"*</b>	3370 mm <b>11'1"*</b>	3370 mm <b>11'1"*</b>
D	3085 mm <b>10'1"</b>	3085 mm <b>10'1"</b>	3085 mm <b>10'1"</b>
E	2970 mm <b>9'9"</b>	3275 mm <b>10'9"</b>	2970 mm <b>9'9"</b>
F	560 mm <b>22"</b>	760 mm <b>30"</b>	760 mm <b>30"</b>
G	65 mm <b>2.6"</b>	65 mm <b>2.6"</b>	65 mm <b>2.6"</b>
H	3545 mm <b>11'8"</b>	3670 mm <b>12'0"</b>	3670 mm <b>12'0"</b>

\*3338 mm **10'11"** is overall height if Komatsu sweeps are installed.

Ground clearance ..... 415 mm **1'4"**

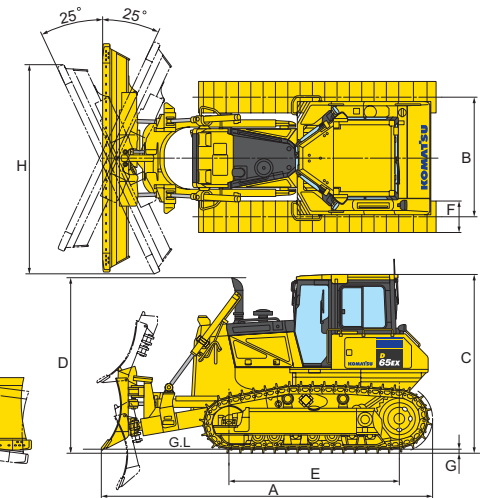
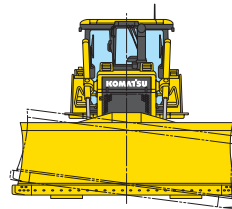

Shown with Power Angle Tilt dozer (D65EX-17) single grouser shoe.



### OPERATING WEIGHT

Tractor weight:

Including ROPS cab, rated capacity of lubricant, hydraulic control unit, coolant, full fuel tank, operator, and standard equipment.

D65EX-17	17730 kg	<b>39,095 lb</b>
D65PX-17	19380 kg	<b>42,725 lb</b>
D65WX-17	18340 kg	<b>40,435 lb</b>

for PAT dozer (EX, WX with rear counterweight)

D65EX-17	18510 kg	<b>40,805 lb</b>
D65PX-17	19380 kg	<b>42,725 lb</b>
D65WX-17	19380 kg	<b>42,725 lb</b>

Operating weight:

Including SIGMADOZER (EX/WX) or straight tilt dozer (PX) or Power Angle Tilt dozer, ROPS cab, operator, standard equipment, rated capacity of lubricant, hydraulic control unit, coolant, and full fuel tank.

D65EX-17	20120 kg	<b>44,355 lb</b>
D65PX-17	21480 kg	<b>47,355 lb</b>
D65WX-17	20840 kg	<b>45,945 lb</b>

for PAT dozer (EX, WX with rear counterweight)

D65EX-17	21470 kg	<b>47,335 lb</b>
D65PX-17	22370 kg	<b>49,315 lb</b>
D65WX-17	22370 kg	<b>49,315 lb</b>



## STANDARD EQUIPMENT FOR BASE MACHINE\*

- Air cleaner, double element with dust indicator
- Alternator, 60 ampere/24V
- Backup alarm
- Batteries, 200 Ah/2 x 12V
- Battery disconnect switch
- Blade lift cylinders
- Color monitor, LCD
- Decelerator pedal
- Engine hood
- Engine intake centrifugal precleaner
- Engine, gull-wing side covers
- Engine shutdown secondary switch
- Fenders
- Front pull hook
- High mount foot rests
- Horn, warning
- Hydraulic driven radiator cooling fan with reverse clean mode
- Hydraulics for rear equipment
- KOMTRAX® Level 4
- Komatsu Diesel Particulate Filter (KDPF)
- Komatsu Variable Geometry Turbocharger (KVGIT)
- Locks, filler caps and covers
- Muffler with curved exhaust pipe
- Oil pressure check ports for power train
- PM service connector
- Radiator mask, heavy-duty, hinged, perforated
- Radiator reserve tank
- Rear cover
- ROPS cab\*\*
  - Air conditioner
  - Cab accessories
    - 12V power supply (2 ports)
    - Cup holder
    - Rearview mirror
    - Rear view monitoring (1 camera)
    - AM/FM Radio w/remote AUX plug (3.5 mm)
  - Shovel holder
  - Work lights
    - 2 front, hood mounted
    - 2 front, cab mounted
    - 1 rear, left fender mounted
    - 2 rear, cab mounted
- Seat, air suspension, fabric, heated low back, rotates 12.5° to right, headrest
- Seat belt, 76 mm **3"**, retractable
- Seat belt indicator
- Sealed electrical connectors
- Secondary engine shutoff switch
- Starting motor, 11.0 kW/24V
- Steering system:
  - Hydrostatic Steering System (HSS)
- Torque converter with auto lock-up
- Track roller guards, center and end sections
- Track shoe assembly
  - Heavy-Duty lubricated rotary bushing (PLUS) track
  - 560 mm **22"** single grouser shoe (EX with PAT)
  - 610 mm **24"** single grouser shoe (EX with outside mount blade)
  - 760 mm **30"** single grouser shoe (WX with outside mount blade)
  - 760 mm **30"** single grouser shoe (PX, WX with PAT)
  - 915 mm **36"** single grouser shoe (PX with outside mount blade)
- Transmission with auto/manual shift modes
- Underguards, heavy duty
  - Hinged belly pan
  - Transmission
- Water separator
- Wide core cooling package

\* Dozer assembly and rear mounted equipment are not included in base machine standard equipment

\*\* Cab meets OSHA/MSHA ROPS and FOPS Level 2 standards



## OPTIONAL EQUIPMENT

- Dozer assembly
- Drawbar, long type
- Hitch
- Rear counterweight 650 kg **1,430 lb**
- Rear counterweight HD 775 kg **1,715 lb**
- Straight tilt frame for use with allied blades
- Topcon® Plug-N-Play bolt-on finishing kit
- Track roller guard, full length
- 560 mm **22"** single grouser HD (EX)
- Tri Link Provision 760 mm **30"** single grouser (WX/PX)

### Multi-shank ripper (for D65EX/WX)

Weight..... 1770 kg **3,900 lb**  
 Beam length..... 2170 mm **7'1"**  
 Maximum lift above ground..... 640 mm **2'1"**  
 Maximum digging depth..... 590 mm **1'11"**



## ALLIED MANUFACTURER'S ATTACHMENTS (SHIPPED LOOSE)

- Guarding - Medford
  - Front sweeps (open top) 126 kg **300 lb**
  - Front sweeps (w/ top cover plate) 204 kg **450 lb**
  - Hinged cab side screens 54 kg **120 lb**
  - Hinged cab rear screen 73 kg **160 lb**
  - Tank guards 431 kg **950 lb**
- Hydraulic winch - Allied H6H 1325 kg **2,900 lb**
- Mechanical angle blade - Rockland 1100 kg **2,425 lb**

