

Sturdy D9H bulldozers are designed for tough dozing, reclamation and push-loading jobs. They're built with unbreakable DH-2 steel cutting edges and end bits. Bulldozer push arms connect to a sliding center ball that reduces side load stresses on the blade and push arms and prevents push arm deformation during blade tilt. And one lever controls all blade movements, including tilt.

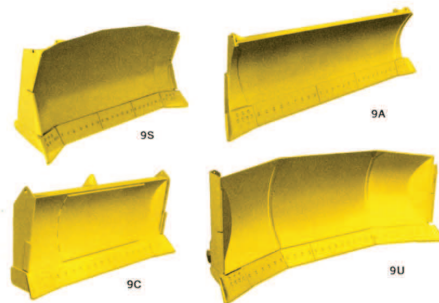

Bulldozer specifications

Blade	Width	Height	Digging Depth	Ground Clearance	Maximum Tilt	Weight (without hydraulic controls)
9S	14'5" (4390 mm)	71.5" (1820 mm)	23" (580 mm)	63.56" (1610 mm)	37.25" (950 mm)	16,880 lb. (7660 kg)
9U	15'9" (4800 mm)	71.5" (1820 mm)	23" (580 mm)	63.56" (1610 mm)	40.5" (1030 mm)	18,730 lb. (8500 kg)
9A, straight	16" (4880 mm)	51" (1300 mm)	24.75" (630 mm)	60" (1520 mm)	14" (356 mm)	15,620 lb. (7090 kg)
Angled 25°	14'2" (4320 mm)	51" (1300 mm)	31.3" (800 mm)	70.25" (1780 mm)	14" (356 mm)	---
9C	10'1" (3070 mm)	60" (1520 mm)	44.64" (1130 mm)	39.5" (1000 mm)	---	13,990 lb. (6350 kg)



standard equipment

19-amp alternator. Air cleaner service indicator. Reversible fan. Fuel priming pump. Muffler. Double universal joint. Bolt-on replaceable sprocket rim segments. Hydraulic track adjusters. Two-position idler. Lifetime-Lubricated rollers and idlers. Rigid drawbar.

ROPS mounting. Seat belt. Power shift transmission. 7-roller track frame. Sealed and Lubricated Track. 24" (610 mm) extreme service tracks (39 section). Track-guiding guards. Crankcase guards. Pull hook. Rain cap. Hinged radiator guard.



optional equipment

(with approximate installed weights)

Air conditioner	340 lb. (154 kg)
Compressor only	66 lb. (30 kg)
Alternator, 50 amp	15 lb. (7 kg)
Cab, ROPS, sound suppressed	3,200 lb. (1450 kg)
Cab comfort group	15 lb. (7 kg)
Canopy, ROPS	1,600 lb. (730 kg)
Counterweight (cannot be used with rear-mounted equipment)	5,000 lb. (2270 kg)
Fan blast deflector	38 lb. (17 kg)
Fast-fill fuel system	20 lb. (9 kg)
Fire extinguisher	30 lb. (14 kg)
Guards:	
Engine, upper	209 lb. (95 kg)
Track roller	1,260 lb. (570 kg)
Heaters:	
Cab	50 lb. (23 kg)
Engine coolant	4 lb. (2 kg)
Hydraulic controls:	
For 9S or 9U Bulldozer	1,210 lb. (550 kg)
For 9A or 9C Bulldozer	1,185 lb. (540 kg)
For 9S or 9U Bulldozer and 9D Ripper, hydraulic	1,380 lb. (630 kg)
Manual	1,375 lb. (620 kg)
For 9A or 9C Bulldozer and 9D Ripper, hydraulic	1,360 lb. (620 kg)
Manual	1,325 lb. (600 kg)

Lighting system, 4 lights	44 lb. (20 kg)
Rear light, for use with ripper (requires 4-light system)	15 lb. (7 kg)
Meter, electric hour	5 lb. (2 kg)
Oil change system	10 lb. (5 kg)
Prescreener	7 lb. (3 kg)
Push block	2,870 lb. (1300 kg)
Push plate	540 lb. (245 kg)
Radiator core protector grid	85 lb. (39 kg)
Ripper pin puller, hydraulic, for single shank ripper	117 lb. (53 kg)
Ripper tooth, for multishank ripper only	800 lb. (363 kg)
Screen for ROPS cab or canopy	96 lb. (44 kg)
Seat, shock-dampening	25 lb. (11 kg)
Starting receptacle	2 lb. (1 kg)
Tool kit	14 lb. (6 kg)
Tracks, pair, 39 section:	
24" (610 mm)	-1640 lb. (-740 kg)
27" (690 mm)	-780 lb. (-354 kg)
27" (690 mm) extreme service	860 lb. (390 kg)
Vandalism protection:	
Instrument panel guard	7 lb. (3 kg)
Cap locks for fuel tank, hydraulic tank, oil filler and radiator	9 lb. (4 kg)
Model 59 Cat Winch	2,550 lb. (1160 kg)
Winch fairlead	820 lb. (372 kg)
Windshield wiper (cab rear)	5 lb. (2 kg)

Materials and specifications are subject to change without notice.

dimensions

Ground clearance from ground face of shoe (per SAE J894) 18.12" (460 mm)
Drawbar height (from ground face of shoe) 24.4" (620 mm)

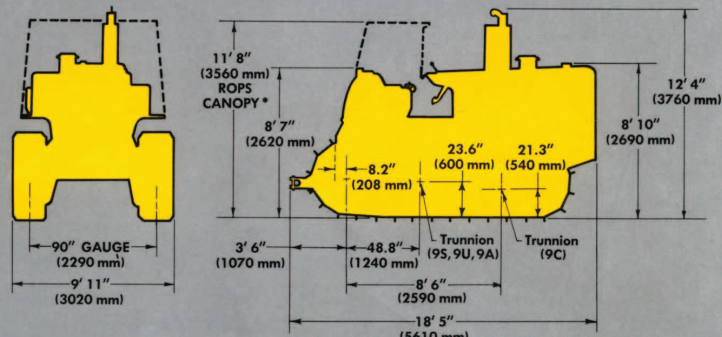

*11' 11" (3630 mm) WITH OPTIONAL SOUND-SUPPRESSED ROPS CAB



©2010 Caterpillar - www.cat.com

CAT, CATERPILLAR, their respective logos, "Caterpillar Yellow," the "Power Edge" trade dress as well as corporate and product identity used herein, are trademarks of Caterpillar and may not be used without permission.

Classic Construction Models, a licensee of Caterpillar Inc.



www.ccmodels.com | (503) 626-6395



CATERPILLAR

D9H

Track-type Tractor

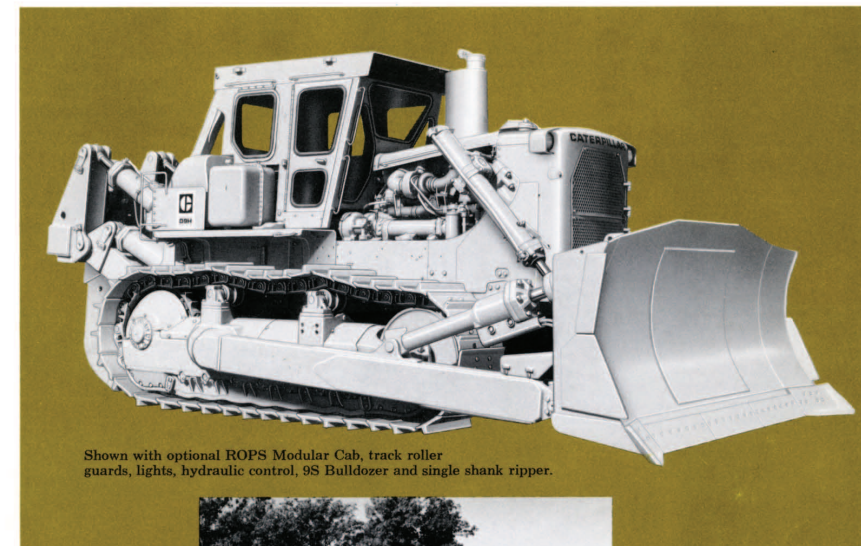

Shown with optional ROPS Modular Cab, track roller guards, lights, hydraulic control, 9S Bulldozer and single shank ripper.



Summary of features

- Turbocharged and aftercooled Cat D353 diesel delivers 410 flywheel horsepower (306 kW) . . . keeps full rated power to 7,500 ft. (2300 m) altitude.
- Sealed and Lubricated Track greatly reduces internal pin and bushing wear . . . for lower undercarriage maintenance costs.
- Pinned equalizer bar restrains track roller frames from excessive lateral movement, thus preventing high bending stresses in the sprocket shafts and misalignment of final drive gears and bearings.
- Combined hand-lever steering both disengages steering clutches and brakes the track . . . hydraulic pilot controls make it smooth and easy to operate dozer tilt cylinder and ripper.
- Caterpillar Modular Cab is a self-contained environmental unit that meets all current OSHA (U.S.A.) requirements for rollover protection. Tilts rearward for easy servicing of power train components.



SERIAL# /1000

It is hereby certified the Cat D9H Track-Type Tractor with the above serial number is an authentic registered Classic Construction Model, one (1) of one thousand (1000) models produced in a strictly limited single edition.

Attested by _____

D9H

Track-type Tractor

engine (continued)

Caterpillar four-stroke-cycle diesel Model D353 with six cylinders, 6.25" (159 mm) bore, 8" (203 mm) stroke and 1473 cu. in. (24.2 litres) displacement.

Turbocharged and aftercooled, with non-clogging individual adjustment-free fuel injection pumps and precombustion chambers. Stellite-faced valves and hard alloy steel seats. Valve rotators provide even heat distribution.

Spray-cooled, cam-shaped and tapered aluminum alloy pistons with three-ring design. Cast-iron ring bands for both compression rings. Steel-backed aluminum alloy bearings. Hi-Electro hardened crankshaft journals. Dry-type air cleaner with automatic dust ejector. Uses economical No. 2 fuel oil (ASTM Specification D396), often called No. 2 furnace or burner oil, with a minimum cetane rating of 35. Premium quality diesel fuel can be used but is not required. 24-volt direct electric starter with 19-amp alternator and two 200-amp, 12-volt batteries.

transmission

Planetary-type power shift with 21" (530 mm) diameter, high-torque-capacity oil clutches. Special modulation system permits unrestricted speed and direction changes under full load.

Single-stage torque converter with output torque divider. Connected to transmission by double universal joint for unit construction.

Gear	Forward Speed		Reverse Speed	
	MPH	(km/h)	MPH	(km/h)
1	0-2.5	(4.0)	0-3.1	(5.0)
2	0-4.3	(6.9)	0-5.4	(8.7)
3	0-6.7	(10.8)	0-8.2	(13.2)

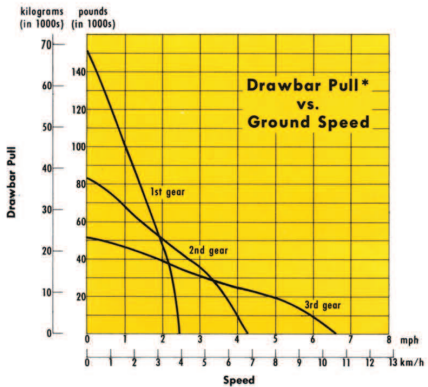

steering

Hydraulically actuated, multiple-disc oil clutches require no adjustment. Oil-cooled, hydraulically boosted contracting band brakes. Clutch and brake assemblies can be serviced as a unit.

Hand levers combine steering clutch disengagement and braking in one control. Pull back slightly to disengage steering clutches, fully back to brake track. Brake pedals are retained for operators who prefer them and for cross steering and emergency stops. Mechanical parking brake.

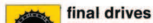

final drives

Planetary-type gearing. Filtered, full-pressure lubrication and Duo-Cone® floating ring seals. Steel final drive cases. Sprockets with bolt-on, replaceable rim segments.



track roller frame

Reinforced box-section construction includes welded-on track-guiding guards with replaceable, bolt-on wear strips. Outside-mounted carrier rollers. Lifetime-Lubricated rollers and idlers with Duo-Cone® floating ring seals. Adjustable, two-position idler. Pinned equalizer bar and diagonal braces hold track roller frames in lateral alignment.

Number of rollers (each side) 7
Oscillation at front idler 17.69" (449 mm)

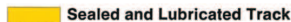

Sealed and Lubricated Track

Sealed and Lubricated Track surrounds the track pin with lubricant to greatly reduce internal bushing wear. Lubricant is held in place by a sealing arrangement consisting of a polyurethane seal, a rubber load ring and a thrust ring. Additional lubricant is contained in a reservoir drilled into the track pin. Extends track wear life and undercarriage maintenance intervals – reduces costs. Hydraulic track adjusters and track-guiding guards standard. Split master link standard.

Number of shoes (each side) 39
Width of standard shoe 24" (610 mm)
Length of track on ground 132" (3350 mm)
Ground contact area with standard shoes 6,338 sq. in. (4.09 m²)
Grouser height (from ground face of shoe) 3.44" (87 mm)

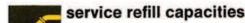

service refill capacities

	U.S. Gallons	(litres)
Fuel tank	230	(870)
Cooling system	41	(155)
Diesel engine crankcase	11.25	(42.6)
Transmission, bevel gear and steering clutch compartments (includes torque converter)	34	(129)
Final drives (each)	11.25	(42.6)



weight (approximate)

Shipping (includes coolant, lubricants, 5% fuel and ROPS mounting) 72,400 lb. (32 840 kg)

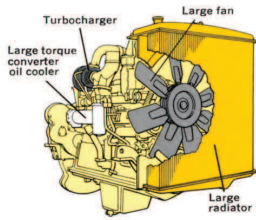

And these design refinements make the D9H a reliable performer:

- Large torque converter oil cooler quickly dissipates heat of the efficient D9H torque converter.
- Ample radiator capacity is eight tube rows for effective cooling.

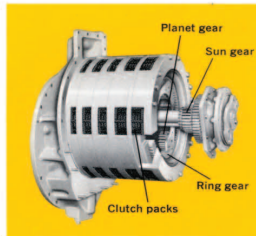

Planetary power shift transmission shifts on-the-move for quick speed and direction changes. Big perimeter clutch packs absorb the shifting forces. And planetary gearing spreads out torque loads rather than concentrating them on a single gear. Hydraulic modulation eases clutch packs together for smooth and fast engagement and disengagement when shifting.

The D9H controls are simple to operate because of two innovations. Your operator can steer completely with just the hand levers. They combine steering clutch disengagement and braking. Pull back slightly for a gradual turn . . . all the way back to brake the track. Or your operator can use the brake pedals if he prefers. And hydraulic pilot controls actuate the dozer tilt and ripper hydraulics . . . so they're smooth and almost effortless to operate.

410 flywheel horsepower (306 kW) Cat D353 diesel delivers high-production dozing, ripping and push-loading. And it includes the many time-proven, dependable benefits of Cat diesel power:

- Adjustment-free fuel system has individual injection pumps and valves that precisely meter the proper amount of fuel for peak performance.
- Turbocharging and aftercooling pack more air into cylinders for more complete combustion, more power.

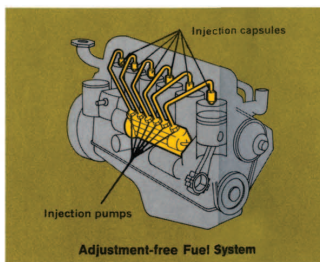

Adjustment-free Fuel System

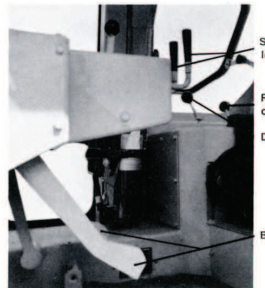
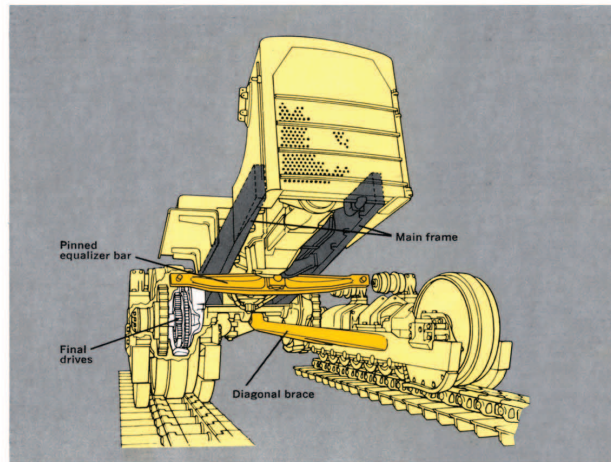

Rugged undercarriage is designed to deliver longer service life with less maintenance:

- Pinned equalizer bar holds track frames in lateral alignment. Keeps track frames from spreading outward under loads . . . reduces stress on final drives.
- Strong box-section main frame features 1.62" (41 mm) thick top rail, 3" (76 mm) thick bottom rail and a depth of 17.9" (455 mm) at the saddle.
- Track rollers have thick guarding to protect against damage.

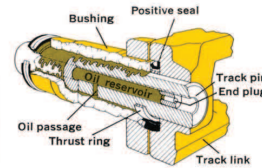
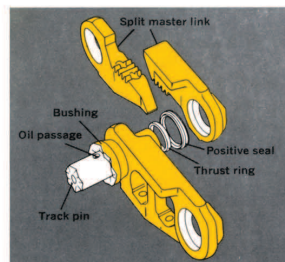

Sealed and Lubricated Track greatly reduces undercarriage maintenance and expenses. A special sealing arrangement holds in an oil film between pin and bushing contact surfaces. It virtually eliminates internal wear. The thicker bushing has longer external wear life. And the pin contains an oil reservoir in the center for continuous lubing. Sealed and Lubricated Track extends component life and noticeably reduces track noise.



Caterpillar Modular Cab (optional) combines increased operator protection, easy servicing and comfortable environment – all in one self-contained, factory-installed unit. The cab has integral ROPS and is sound suppressed. All controls are self-contained, and they disconnect so that the entire cab tilts rearward for servicing power train components. The cab has integral air filtration and pressurization and contains the housing for adding the optional 35,000 BTU/hr. (10 260 W) air conditioner and heater.

Single Shank Ripper



No. 9 Series D Rippers are parallelogram design for strength and ability to keep a nearly constant penetration angle. And you can adjust the angle hydraulically for best penetration of any material. A hydraulic pin puller is available with the single shank ripper (shown at right), so your operator can adjust shank length from his seat (standard on deep-ripping arrangement). Multishank ripper lets you use up to three shanks, depending on job conditions.

Ripper specifications

Ripper	Beam Width	Cross Section	Maximum Penetration	Maximum Clearance Raised	Shank Positions	Weight (without hydraulic controls)
Single shank, standard	4'6" (1370 mm)	17" x 19" (432 x 483 mm)	53.5" (1360 mm)	44.5" (1130 mm)	4	13,630 lb. (6180 kg)
Single shank, deep ripping	4'6" (1370 mm)	17" x 19" (432 x 483 mm)	77.5" (1970 mm)	44.5" (1130 mm)	6	14,050 lb. (6390 kg)
Multishank	9'10" (3000 mm)	17" x 19" (432 x 483 mm)	38.5" (980 mm)	34.5" (880 mm)	2	14,150 lb. (6420 kg)