

# KOMATSU

## D375A-5

NET HORSEPOWER  
391 kW 525 HP @ 1.800 rpm

OPERATING WEIGHT  
69.560 kg

BLADE CAPACITY  
Semi-U: 18,5 m<sup>3</sup>  
Full-U: 22,0 m<sup>3</sup>

**D**  
**375**

CRAWLER DOZER



## D375A-5

# WALK-AROUND

## **Komatsu-integrated design**

For the best value, reliability, and versatility. Hydraulics, power train, frame, and all other major components are engineered by Komatsu. You get a machine with components that are designed to work together to deliver higher production levels, greater reliability, and more versatility.

## **VHMS (Vehicle Health Monitoring System)**

VHMS controller monitors the health conditions of major components and enables analyses of the machine and its operations.

## **Extra-low machine profile**

The low center of gravity provides excellent machine balance.

## **Preventative maintenance**

- Centralised service station electronically controlled
- Enclosed hydraulic piping
- Modular power train design
- Oil pressure check ports

## **Large blade capacities**

- 18,5 m<sup>3</sup> (Semi-U dozer)
- 22,0 m<sup>3</sup> (Full-U dozer)

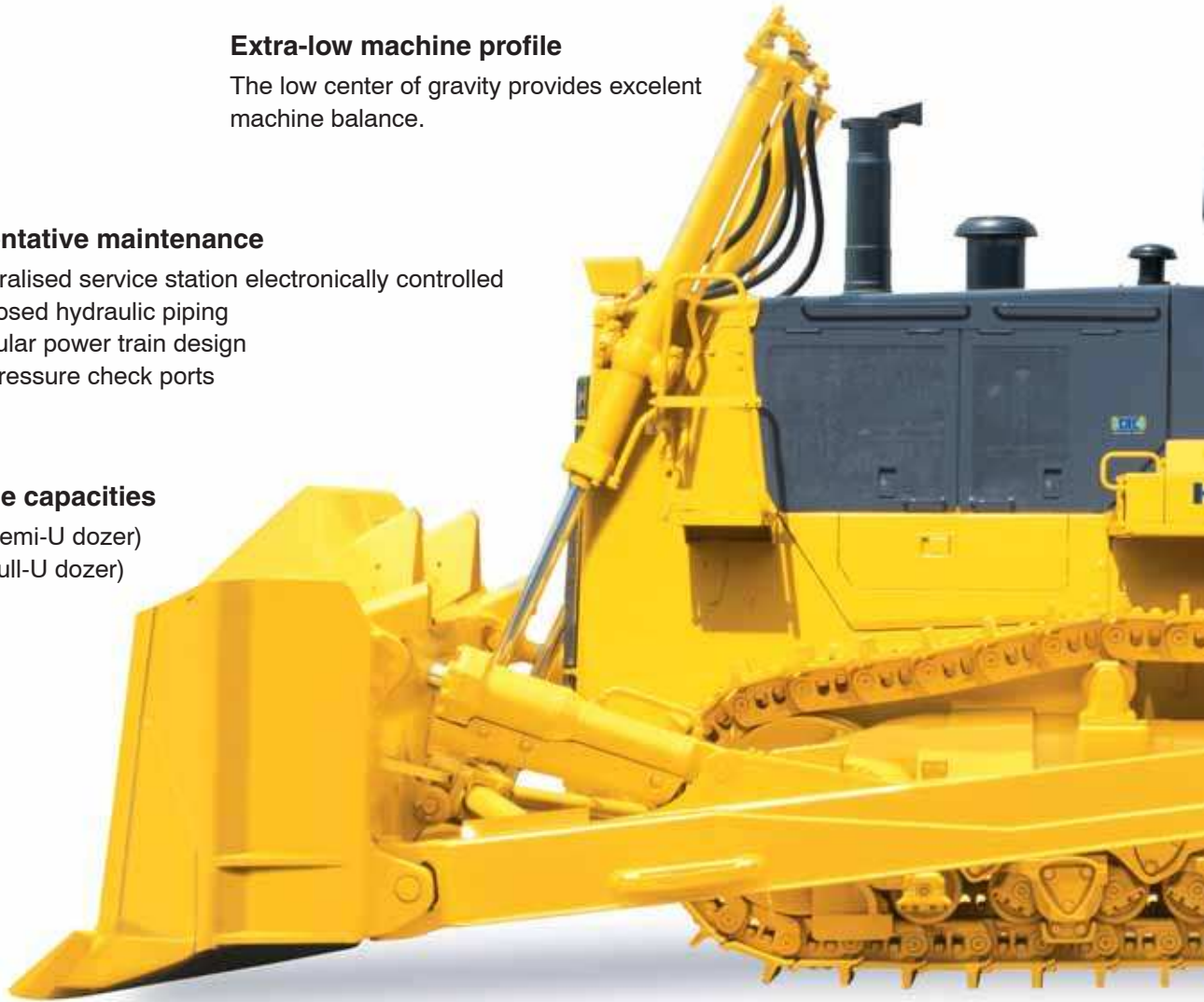

## **Improved operation systems**

- Track shoe slip control system (option) reduces operator fatigue
- Automatic lock-up torque converter saves fuel and increase dozing speed on long pushes

**NET HORSEPOWER**  
391 kW 525 HP

**OPERATING WEIGHT**  
69.560 kg

**BLADE CAPACITY**  
Semi-U: 18,5 m<sup>3</sup>  
Full-U: 22,0 m<sup>3</sup>

**New hexagonally designed cab includes:**

- Spacious interior
- New cab damper for comfortable ride
- Excellent visibility
- High capacity air conditioning system
- PCCS (Palm Command Control System) lever for direction and blade control
- Pressurised cab
- Adjustable armrests
- State-of-the-art highback seat
- Pre radio installation kit
- 12 V connector

**ecot3**  
ecology & economy - technology 3

**Komatsu SAA6D170E-5**

engine with high pressure common rail injection delivers ample power in a fuel efficient way. The engine meets EU Stage IIIA and EPA Tier III emissions regulations.

**Rippers (option)**

- Variable giant ripper
- Variable multishank ripper



**Undercarriage**

- K-Bogie undercarriage system improves traction, component durability, and operator comfort
- New track link design reduces maintenance costs

# COMFORTABLE ERGONOMIC CONTROL

Komatsu's new cabin meets the needs of operators who work long shifts

## PCCS (Palm Command Control System)

Komatsu's new 'PCCS' ergonomically designed control system delivers a work environment with complete operator control.

### Human-machine interface

#### Palm command electronic controlled travel joystick

The palm command travel joystick provides the operator with an environment that supports a comfortable posture and precise machine control, without fatigue. Shifting gears is easily carried out with the gear shift lever's push button control.

All of the signals are transmitted via an engine and transmission controller, preventing overload of the hydraulic steering system and protecting hydraulic and mechanical parts. Because the controller linkages between the engine speed dial, decelerator pedal, and the engine are electrical, there is no wear of moving linkage parts.



Left hand joystick

### Power train electronic control system

#### Smooth and soft operation controlled by the engine and transmission controller

The D375A-5 utilises a newly designed power train electronic control system. The controller registers the amount of operator control (movement of lever and operation of switches) along with machine condition signals from each sensor, such as the engine speed and machine angle. This is then used to accurately control the torque converter, transmission, steering clutches and brakes, for optimised machine operations.

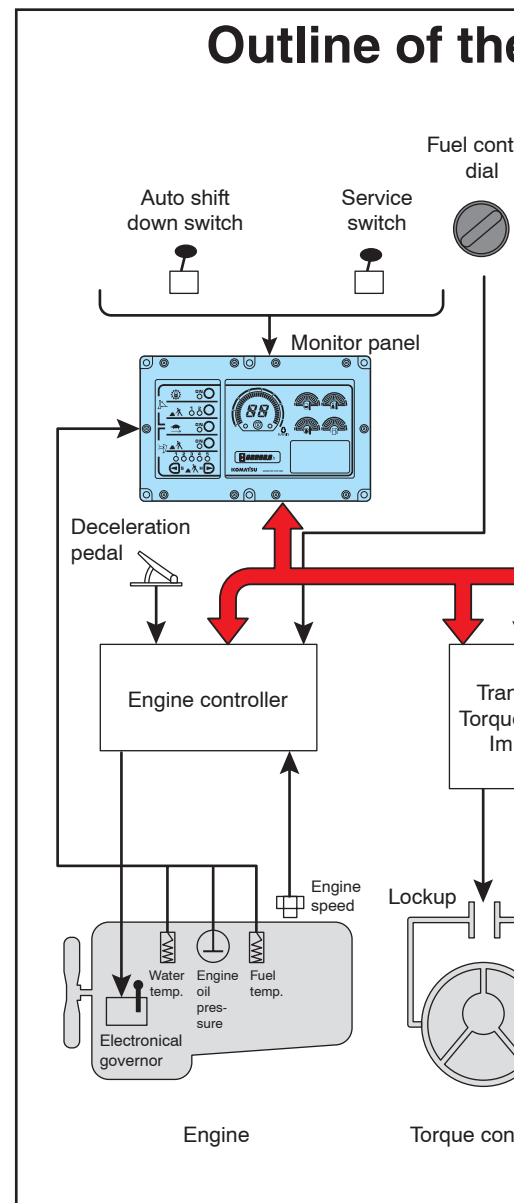

# POWER TRAIN ELECTRONIC CONTROL

## Engine controller

By controlling the fuel injection system, the engine controller optimises fuel consumption in combination with the required power. It works on three levels:

- **Passive:** manages actual work condition information, provides an on-board operation manual, and reports machine history.
- **Active:** provides the error code and acts as a warning system, helping reduce expensive machine break-downs.
- **Measuring tool:** The service technicians can see the various machine parameters without a need for special, expensive hardware and software. This also makes technical information immediately available, optimising operating time.

## Electronic Control System

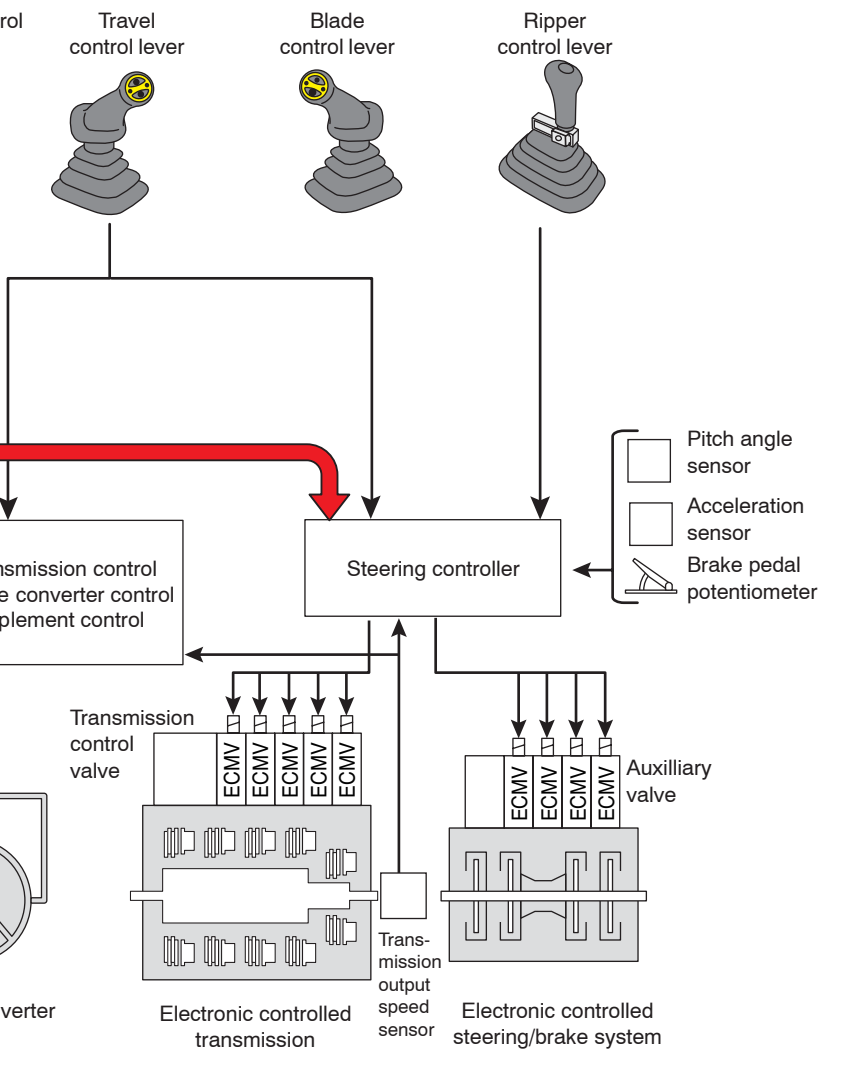

### Blade and ripper control joystick

The blade and ripper control joysticks have an ergonomic design and allow long operator work shifts with fine blade control.

### Engine speed control dial

The rate of engine RPMs is continuously controlled and checked by the engine controller in function of the requested load, saving on fuel. Because the controller linkages between the engine speed dial, decelerator pedal, and the engine are electronic, there is no wear of moving linkage parts.



# PRODUCTIVITY FEATURES

## ECMV (Electronically Controlled Modulation Valve) steering clutches/brakes

Using an innovative series of valves, the transmission controller automatically and smoothly makes each clutch engagement. The speed of each shift is based on travel conditions such as gear speed, engine RPMs and the current shifting sequence. This provides a smooth, shock-free clutch engagement, longer component life, and increased ride comfort. It also assists productivity because the ECMV manages the transmission, allowing the operator to concentrate on managing the blade position.

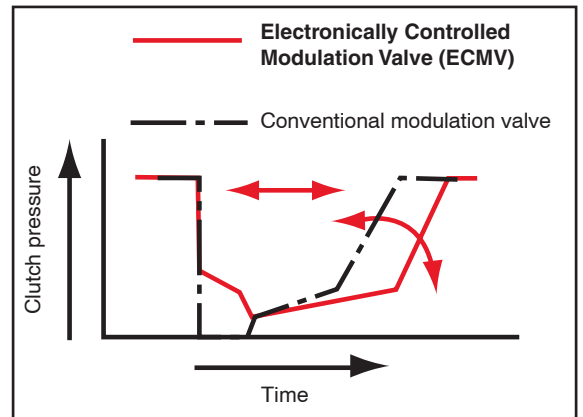

## Advantages of ECMV steering clutches/brake control

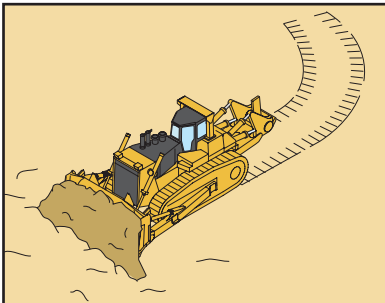

When dozing and turning, the ECMV automatically controls the stroke ratio of the steering clutches and brakes, depending on degree of load, enabling smooth dozing and turning.

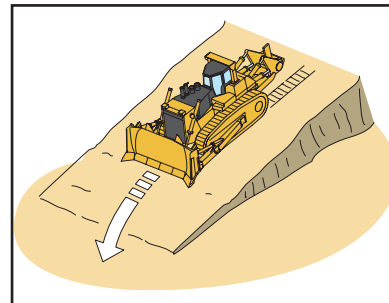

When dozing downhill, the ECMV automatically controls the steering clutches and brakes depending on incline of the machine or degree of load, reducing counter-steering and enabling smooth dozing operations.

## Transmission

The Komatsu planetary powershift transmission offers 3 forward speeds and 3 reverse speeds. The large-sized transmission utilises electronically controlled modulation valves. This allows the transmission to determine the optimum time to shift, depending on the application and machine operating conditions. As a result, stress on the power train is reduced, and driving comfort is increased.

## Preset travel speed selection function

The preset travel speed selection function is standard equipment, enabling the operator to select forward and reverse travel speeds within 3 preset patterns such as F1-R2, F2-R2 and manual shift. When the F1-R2, or F2-R2 preset pattern is selected, and travel control joystick moves to a forward/reverse direction, the machine automatically travels forwards/backwards at the preset F1/R2 or F2/R2 speeds. This function reduces gear shifting time during repeated round-trip operations.

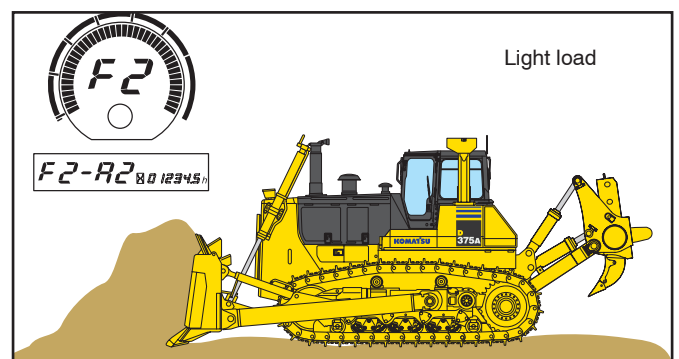
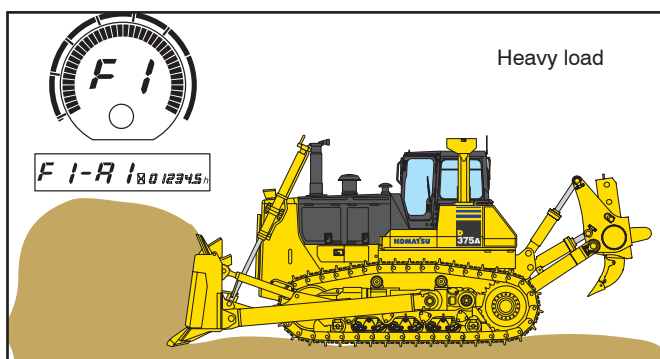
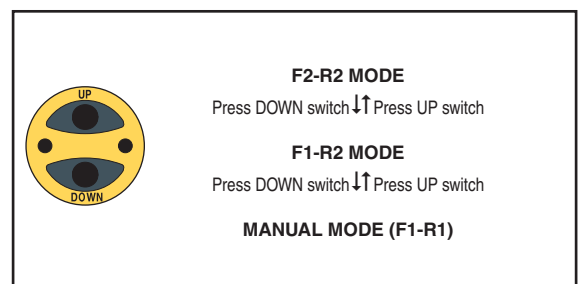

Auto-downshift function

Actuated on heavy load  
or steep slopes

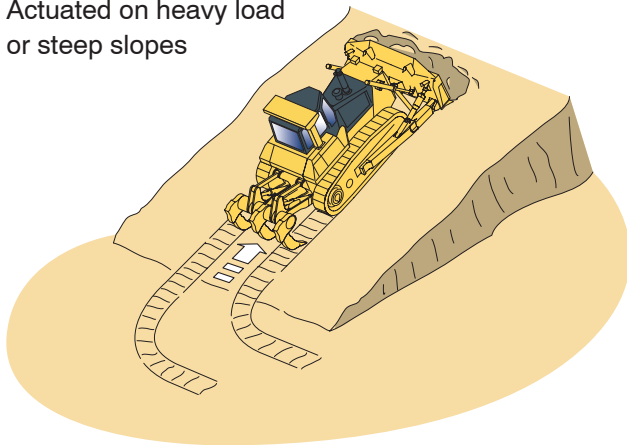

### Auto-downshift function

The engine controller monitors engine speed, travel gear and travel speed. When a load is applied and the machine travel speed is reduced, the controller automatically downshifts and optimises the gear speed to provide high fuel efficiency. This function provides comfortable operations and high productivity without manual downshifting. (This function can be deactivated by a cancel switch on the monitor panel.)



Track shoe slip control panel

### Track shoe slip control system (option)

- Eliminates the need for the operator to continuously control the engine power output with the decelerator whilst ripping. Operator fatigue is reduced substantially.
- Manoeuvrability is improved because the operator is free to concentrate on the ripping application without having to monitor track shoe slippage.
- Repair costs are significantly lowered and undercarriage life is prolonged with the reduction of track shoe slippage.
- The track shoe slip control system contributes to lower fuel costs, because the engine output is automatically controlled to optimum levels for each operation.

### Torque converter

The highly efficient single-stage torque converter provides a high torque increase under changing load conditions, always providing optimal dozer performance. The torque converter provides a shockless, smooth power transfer between engine and transmission, resulting in superior operator comfort and a long power train lifetime.

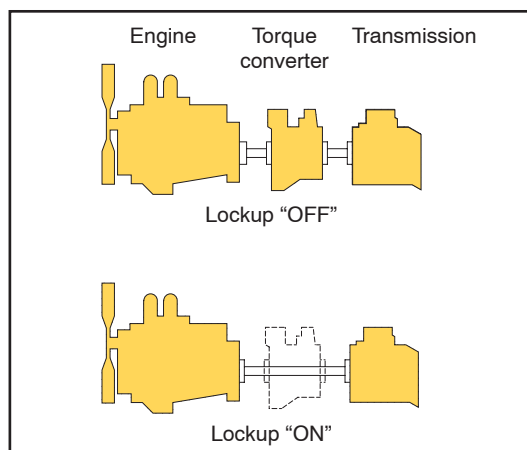

### Torque converter lock-up system

The torque converter is standard equipped with a lock-up system, bringing the power train efficiency of the Komatsu D375A-5 to the highest level in its class. A selection switch on the monitor panel allows the operator to make two choices: the normal torque converter working mode, used during ripping and digging operations and the torque converter lock-up mode used during dozing operations. When the "torque converter lock-up mode" is chosen, the transmission controller will automatically engage and disengage the torque converter lock-up system. In this way the power train will automatically use the best mode, combining highest traction force and speed with the lowest fuel consumption.

# NEW ECOT3 ENGINE

## Komatsu's innovative engine technologies

### A clean, powerful engine

The powerful yet fuel-efficient engine makes the D375A-5 an outstanding performer in both ripping and dozing operation. The SAA6D170E-5 surpasses European Stage IIIA and EPA Tier III emissions regulation. It features direct fuel injection, a turbocharger, an aftercooler and EGR for maximum fuel efficiency.

### Heavy duty HPCR system

#### (High Pressure Common Rail fuel injection)

A high pressure pump pumps fuel into an accumulator chamber or 'Common Rail'. An ECU (electronic control unit) then optimizes fuel injection from the common rail into the engine cylinders. This improves engine power and fuel efficiency, reducing emission and noise levels.

### Heavy-duty cooled EGR system

#### (Exhaust Gas Recirculation)

Cooled exhaust gas returned to the cylinders prevents nitrogen and oxygen bonding during combustion, reducing NOx emissions, lowering thermal stress and improving fuel efficiency.

### Air-to-air charge air cooling system

By cooling the compressed air supplied by the turbocharger to the cylinders, this system optimizes combustion efficiency, reduces emissions and improves engine performance.

### New combustion system

Our new combustion system optimises combustion timing and ignition. Thanks to extensive computer simulations and analyses, its specially designed combustion chamber reduces NOx and particulates emissions, fuel consumption and noise levels.

### Improved efficiency with hydrostatic-driven engine cooling fan

Fan rotation is automatically controlled, based on the coolant and hydraulic oil temperature. This saves fuel and provides great productivity with a quiet operating environment.

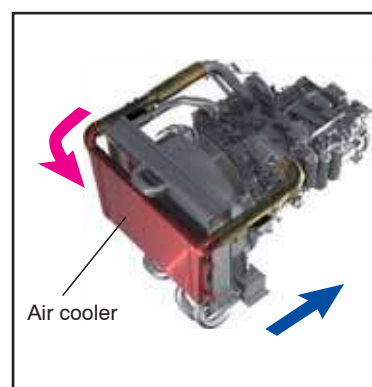
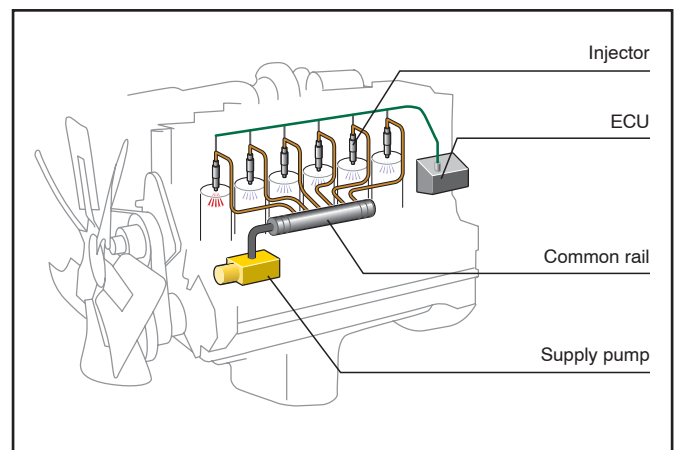



# WORK EQUIPMENT

## Blades

Komatsu uses a box blade design, offering the highest resistance for a low weight blade. This increases total blade manoeuvrability. High-tensile-strength steel has been incorporated into the front and sides of the blade for increased durability. The blade shape design makes it easy to handle a wide range of materials, offering good blade penetration, combined with a low blade rolling resistance. And finally, Komatsu blades help deliver very good, lower fuel consumption performance.

## Semi-U blade

The Komatsu Semi-U blade is designed to stand up to the toughest applications. The shape of the blade gives excellent ground penetration. Its two side wings prevent material spillage, giving class-leading dozing performance.

## U blade

The Komatsu U blade has been especially designed to doze large capacities of product with a minimum of spillage. Apart from the large capacity the excellent blade design also offers a good rolling performance, getting the best out of the dozer.



## Rippers

Komatsu rippers combine the highest productivity and longevity. The shank is fitted with specially designed wear parts to extend lifetimes and deliver the best penetration into any material. Komatsu's patented variable-angle rippers provide the ideal bolder removal action. Their special design allows the cylinders to work in harmony for the ideal combination of ripper-point movement and lifting-out force. What's more, you have precise control over the ripper-point angle to ensure maximum productivity.



# UNDERCARRIAGE

## Low drive undercarriage

Komatsu's design is extraordinarily tough and offers excellent grading ability and stability. Heavy-duty link assemblies with large-diameter bushings, substantial track link height, and superior oil seals increase undercarriage durability and lifetime. Serviceability is also assisted by the remote greasing of the equaliser bar centre pin. And the segmented sprockets can be replaced individually, by hand, making it possible for one mechanic to carry out replacements at the job site. The design also gives the driver a perfect view of the blade tips, making work easier and more precise.

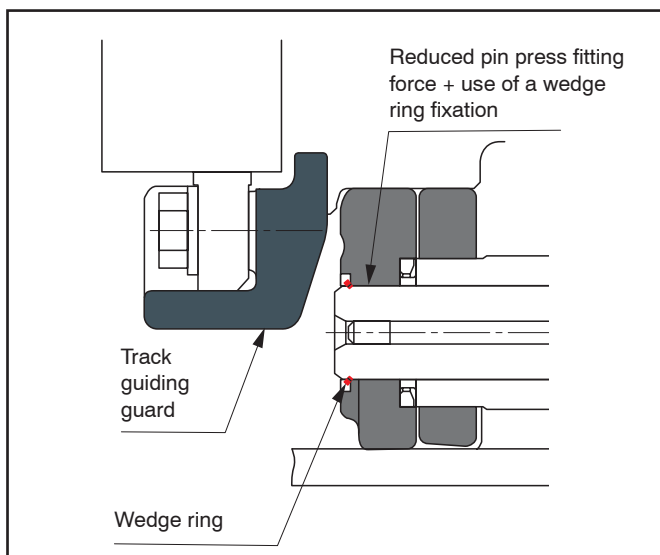
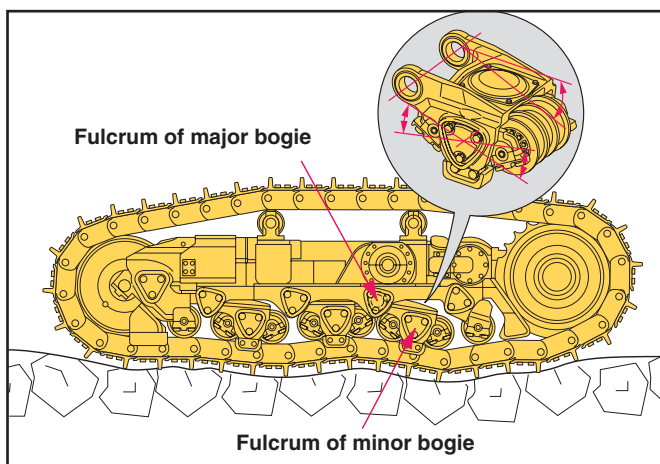
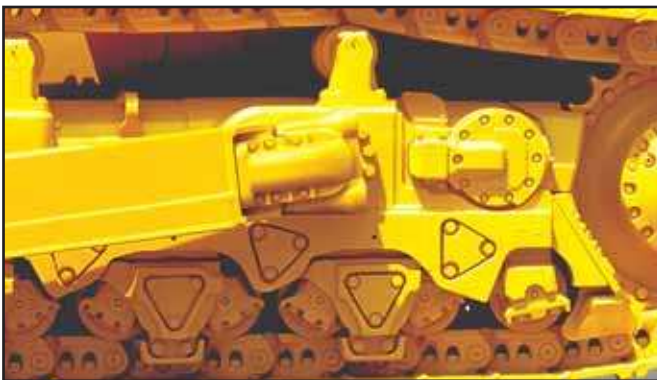

### K-Bogie undercarriage system

The K-bogie undercarriage system is constructed with a fixed idler and flexible mounted track rollers. The track rollers are mounted by pair on a twin bogie system, allowing a high vertical track roller movement.

### K-Bogie features

- The K-bogie system provides an excellent support on the link assembly, even under difficult working conditions
- The link assembly is always in contact with the ground, offering the best transfer of traction force
- Impact loading of the undercarriage components is reduced and the durability of the components is largely increased
- Riding comfort is improved by reducing vibration and shocks, even when travelling over rough terrain
- The new 8 track roller design with flexible mounted idler and track rollers gives the dozer an important net track length on ground, combined with a smooth drive over rough underground

### Track link with wedge ring

New D375A-5 track links feature reduced press-fit force and a wedge ring. This results in easier maintenance with easy turning of pins and bushings. The result is improved undercarriage life and reduced maintenance costs, greater pin reusability, and reduced maintenance man-hours.

# OPERATOR COMFORT

## Operator comfort

Operator comfort is essential for safe and productive work. The D375A-5 provides a quiet, comfortable environment where the operator can concentrate on the work at hand.



## Comfortable ride with new cab damper mounting

D375A-5's cab mounts use a newly designed cab

damper that provides an excellent shock and vibration absorption capacity with its long stroke. Cab damper mounts soften shocks and vibrations that conventional mounting systems are unable to absorb, whilst travelling

over adverse ground conditions. The cab damper spring isolates the cab from the machine body, suppressing vibrations and providing a quiet, comfortable operating environment.

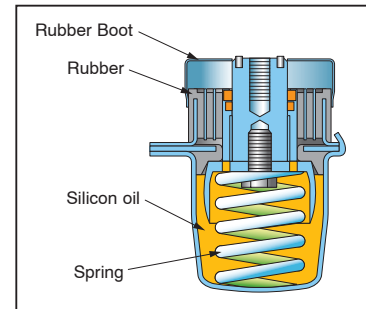

## Pressurised hexagonal cab

- The cab's new hexagonal design and large tinted glass windows provide excellent front, side, and rear visibility
- Superior cab sealing, air filters and increased internal air pressure prevent dust from entering the cab
- The high quality cab interior is fully lined with sound-absorbent material

## Superior blade and ripper visibility

The slim engine bonnet and well-located operator seat provide excellent blade visibility. Finish grading and rough grading can both be performed easily, significantly reducing cycle times. The special shape

of the fuel tank allows the operator to have a clear view on the total width of the dozer back side, not only on the ripper point. This improves the ripper efficiency and safety level.



## Fully-adjustable suspension seat and travel control console

The comfortable, heavy-duty ergonomic seat gives the operator a secure and comfortable work environment. During dozing operations, the seat faces straight forward, resulting in the best blade visibility to the left and right. For reverse and ripping operations, the operator's seat can be turned 15° to the right, significantly improving rear visibility and reducing neck strain. The travel control joystick, with its complete console, can be moved forward, backward, and up and down, so that it's fitted to each operator. It's also linked to the turn function of the seat. As a result it's always located in the optimum position for the operator.



## EASY MAINTENANCE

### Preventative maintenance

Preventative maintenance is the only way to ensure long service life from your equipment. That's why Komatsu designed the D375A-5 with conveniently located maintenance points, to make required inspections and maintenance quick and easy.

### Centralised service station

To assure convenient maintenance, all hydraulic and lubrication oil filters have been centralised to make access to all service points safe and easy.



### Monitor with self-diagnostic function

The monitor panel has a multifunction purpose. It offers:

- Hour meter, engine RPM, fuel gauge and water coolant temperature information, in real time
- Preventative maintenance information such as the timing for the replacement of oil filters
- Service information to inform the operator when abnormalities occur
- Komatsu mechanics receive all available detailed information, without the use of any external service tools

### Gull wing engine side covers

Gull wing engine side covers facilitate easy engine maintenance and filter replacement. The side covers are a solid structure with a bolt-on latch to improve durability and repairability.

### Highly reliable electric circuit

Electrical circuit reliability is increased by utilising dust, vibration and corrosion resistant "DT connectors". The reinforced electrical wiring harnesses include a circuit breaker, and are covered with a heat-resistant material to increase mechanical strength, provide longer life, and protect the system from damage.

### O-ring face seal

The hydraulic hose connections use high quality O-ring face seals. They provide improved sealing performance against vibrations and load shocks.



### Enclosed hydraulic piping

The hydraulic piping for the blade tilt cylinder is completely housed in the push arm, ensuring damage protection.

### Modular power train design

Power train components are sealed in a modular design that allows them to be dismantled and mounted without oil spillage. This makes servicing work clean, smooth, and easy.

### Maintenance-free disc brakes

Wet disc brakes require less maintenance.

# SERVICEABILITY AND CUSTOMER SUPPORT

## Serviceability and Customer Support

The Komatsu dealer network guarantees you the lowest operating costs.

When you purchase Komatsu equipment, you gain access to a broad range of programmes and services that have been designed to help you get the most from your investment. These all support substantial productivity, long and useful equipment lifetime, low operating costs, and a high trade-in or resale value.

- Many of the vital components in the D375A-5 have been installed and proven totally reliable in other heavy-duty Komatsu earthmoving equipment.
- Komatsu's extensive parts warehouses and logistics system across Europe and around the globe ensure unparalleled parts availability.
- Continuous training programmes for Komatsu service personnel guarantee that your equipment is serviced properly and maintained in top running condition.
- The Komatsu Oil Wear Analysis (KOWA) programme offers sophisticated oil analysis to identify problems to be followed up during preventative, scheduled maintenance.
- KFWP (Komatsu's Flexible Warranty Programme) is available, providing a range of extended warranty options on the machine and its components. These can be chosen, based on individual needs and activities. This programme is designed to help reduce total operating costs.
- A Komatsu Repair & Maintenance Contract is a way to establish a fixed operating cost and ensure optimal machine availability for the duration of the contract.



### VHMS (Vehicle Health Monitoring System)

The VHMS controller monitors the health conditions of major components and enables analysis of the machine and its operations. The VHMS controller monitors and stores all data received from the engine and transmission controller and various additional sensors on the major components. This way, it's possible to record the evolution of the machine's health condition. This data can be downloaded via a portable computer or via satellite communication. In both cases, Komatsu specialists can analyse this downloaded data and follow up trends in the machine's condition. When using satellite communications, the Komatsu specialist can inform you whenever an abnormal condition occurs. This way, repair and maintenance costs can be optimised, and maximum machine availability can be maintained.

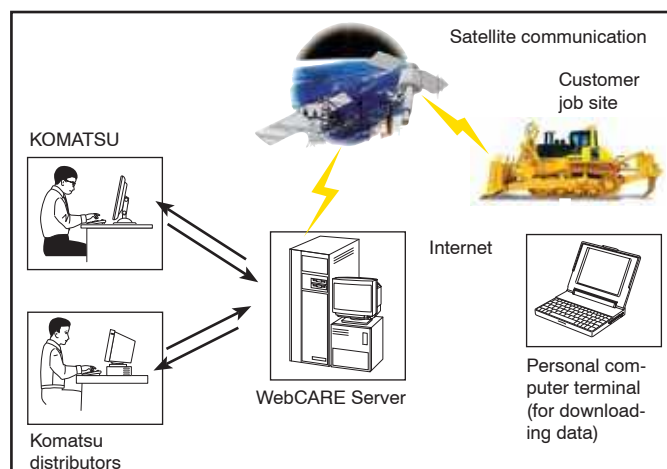

# SPECIFICATIONS



## ENGINE

Model ..... Komatsu SAA6D170E-5  
 Type ..... Common rail direct injection, water-cooled, emissionised, turbocharged, after-cooled diesel

Rated capacity  
 ISO 9249 / SAE J1349\* ..... 391 kW/525 HP @ 1.800 rpm

No. of cylinders ..... 6  
 Bore x stroke ..... 170 x 170 mm  
 Displacement ..... 23,15 ltr  
 Governor ..... All-speed, electronic  
 Fan drive type ..... Hydraulic  
 Lubrication system  
 Method ..... Gear pump, force lubrication  
 Filter ..... Full flow

\*Net horsepower at maximum speed of the radiator cooling fan ..... 391 kW 525 HP (net horsepower of this machine is controlled to be constant regardless of the fan speed)



## TORQFLOW TRANSMISSION

Type ..... Komatsu TORQFLOW  
 Torque converter ..... 3-element, 1-stage, 1-phase, water-cooled with lock-up clutch  
 Transmission ..... Planetary gear, multiple-disc clutch hydraulically actuated, force-lubricated  
 Gearshift lock lever and neutral safety switch prevent accidental starts.

Max. travel speeds	Forward	Reverse
1st	3,5 km/h	4,6 km/h
2nd	6,8 km/h	9,2 km/h
3rd	11,8 km/h	15,8 km/h

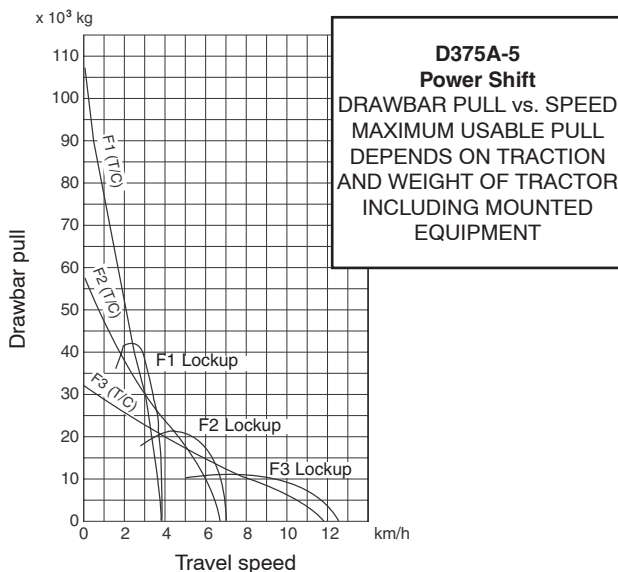

## ENVIRONMENT

Engine emissions ..... Fully complies with EU Stage IIIA and EPA Tier III exhaust emission regulations

Noise levels  
 LwA external ..... 113 dB(A) (2000/14/EC)  
 LpA operator ear ..... 77 dB(A) (ISO 6396 dynamic test)



## STEERING SYSTEM

Type ..... Clutch and brake steering system  
 Steering control ..... PCCS-lever  
 Steering brakes ..... Wet, multiple-disc, pedal-/hand controlled, spring-loaded and hydraulically released  
 Interconnected with steering clutch  
 Steering clutch ..... Wet multiple-disc clutch. Spring loaded, hydraulically released, hand operated, interconnected with steering brake.  
 Service brakes ..... Steering brakes function as service brake, pedal-controlled

Minimum turning radius (counter-rotation)  
 (as measured by track marks on ground) ..... 4,2 m



## UNDERCARRIAGE

Suspension ..... Oscillating equaliser bar and pivot shaft  
 Track roller frame ..... Monocoque, large section, durable construction  
 Rollers and idlers ..... Lubricated track rollers  
 K-Bogie undercarriage ..... Lubricated track rollers are resiliently mounted on the track frame with a bogie suspension system  
 Tracks ..... Lubricated tracks, fully sealed  
 Track tension ..... Combined spring and hydraulic unit  
 Number of shoes (each side) ..... 41  
 Grouser height (single grouser) ..... 93 mm  
 Shoe width (standard) ..... 610 mm  
 Ground contact area ..... 48.560 cm<sup>2</sup>  
 Track rollers (each side) ..... 8  
 Carrier rollers (each side) ..... 2

Extreme service shoes	Additional weight	Ground contact area
710 mm	680 kg	56.520 cm <sup>2</sup>
810 mm	1.360 kg	64.480 cm <sup>2</sup>



## COOLANT AND LUBRICANT CAPACITY (REFILLING)

Fuel tank ..... 1.050 ltr  
 Radiator ..... 120 ltr  
 Engine oil ..... 86 ltr  
 Torque converter, transmission, bevel gear and steering system ..... 150 ltr  
 Final drive (each side) ..... 65 ltr  
 Dozer blade and ripper hydraulics ..... 138 ltr



## FINAL DRIVE

Type ..... Spur gear single reduction and planetary gear single reduction, splash lubrication  
 Sprocket ..... Segmented sprocket teeth are bolt-on for easy replacement



**DIMENSIONS**

	D375A-5
A	2.500 mm
B	4.695 mm
C	4.265 mm
D	2.265 mm
E	3.980 mm
F	10.410 mm
G	3.450 mm
H	1.435 mm
I	1.370 mm
J	4.285 mm

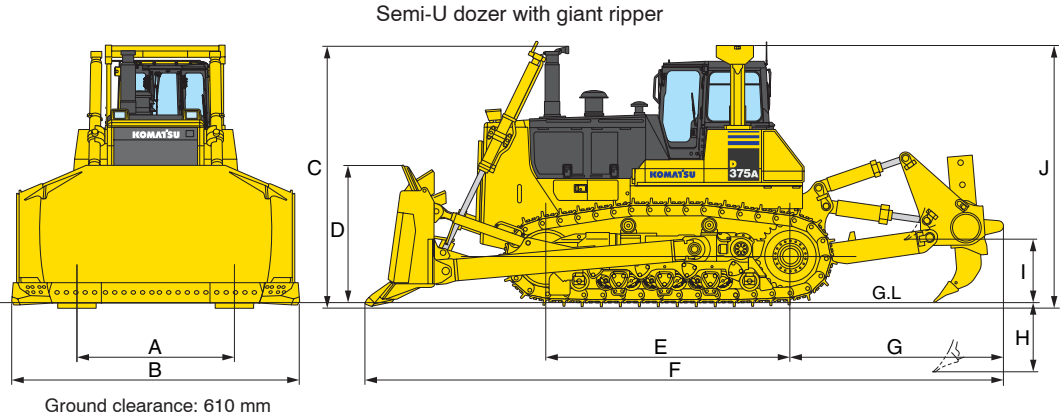

**OPERATING WEIGHT (APPR.)**

Including strengthened semi-U tilt dozer, giant ripper, steel cab, ROPS, operator, standard equipment, rated capacity of lubricant, coolant, and full fuel tank, 610 mm shoes.

Operating weight ..... 69.560 kg



**HYDRAULIC SYSTEM**

Type ..... Closed-centre load sensing system  
 All spool valves externally mounted beside the hydraulic tank.  
 Main pump ..... Gear pump  
 Maximum pump flow ..... 405 ltr/min  
 Relief valve setting ..... 210 kg/cm<sup>2</sup>  
 Spool control valve positions semi-U tilt dozer and full-U tilt dozer  
 Blade lift ..... Raise, hold, lower, and float  
 Blade tilt ..... Right, hold, and left  
 Additional control valve positions for rippers  
 Ripper lift ..... Raise, hold, and lower  
 Ripper tilt ..... Increase, hold, and decrease  
 Hydraulic cylinders ..... Double-acting, piston  
 No. of cylinders x bore  
 Blade lift ..... 2 x 150 mm  
 Blade tilt (single tilt) ..... 1 x 225 mm  
 Ripper lift ..... 2 x 225 mm  
 Ripper tilt ..... 2 x 200 mm



**RIPPER EQUIPMENT**

Multishank ripper  
 Type ..... Hydraulically controlled variable ripper  
 No. of shanks ..... 3  
 Weight (including hydraulic control unit) ..... 6.720 kg  
 Beam length ..... 2.854 mm  
 Maximum lift above ground ..... 1.140 mm  
 Maximum digging depth ..... 1.020 mm

Giant ripper  
 Type ..... Hydraulically controlled variable ripper  
 Ripping depth is adjustable in three stages by a hydraulically controlled pin puller  
 No. of shanks ..... 1  
 Weight (including hydraulic control unit) ..... 5.470 kg  
 Beam length ..... 1.367 mm  
 Maximum lift above ground ..... 1.470 mm  
 Maximum digging depth ..... 1.370 mm



**DOZER EQUIPMENT**

Blade capacities are based on the SAE recommended practice J1265.

	Overall length with dozer	Blade capacity	Blade width x height	Maximum lift above ground	Maximum drop below ground	Maximum tilt adjustment	Additional weight
Semi-U blade single tilt	7.635 mm	18,5 m <sup>3</sup>	4.695 x 2.265 mm	1.660 mm	715 mm	1.065 mm	10.910 kg
Strenghtened semi-U blade single tilt	7.635 mm	18,5 m <sup>3</sup>	4.695 x 2.265 mm	1.660 mm	715 mm	1.065 mm	11.640 kg
Semi-U blade dual tilt	7.635 mm	18,5 m <sup>3</sup>	4.695 x 2.265 mm	1.660 mm	715 mm	1.150 mm	11.290 kg
Strenghtened semi-U blade dual tilt	7.635 mm	18,5 m <sup>3</sup>	4.695 x 2.265 mm	1.660 mm	715 mm	1.150 mm	12.020 kg
Strenghtened U blade single tilt	8.000 mm	22,0 m <sup>3</sup>	5.140 x 2.265 mm	1.660 mm	715 mm	1.065 mm	12.420 kg
Strenghtened U blade dual tilt	8.000 mm	22,0 m <sup>3</sup>	5.140 x 2.265 mm	1.660 mm	715 mm	1.260 mm	12.800 kg

# CRAWLER DOZER

## STANDARD EQUIPMENT

### Cab

- Suspension seat: fabric, reclining, high backrest, turnable
- Seat belt
- Headrest
- High mount footrest
- Palm lever steering control (PCCS)
- Mono lever blade control
- Air conditioner
- Pre radio installation kit (12 V, antenna, loudspeakers)
- Decelerator pedal
- Electronic monitor panel
- Viscous cab mounts
- Fenders
- Rear-view mirror (inside cab)
- Sun visor
- Cup holder
- Lunch box holder

### Undercarriage

- Single grouser heavy-duty shoes 610 mm
- Heavy-duty link assembly, sealed and lubricated
- Segmented sprockets
- K-Bogie system
- K-Bogie roller guards
- Flexible idler
- Hydraulic track adjusters

### Control systems

- VHMS (Vehicle Health Monitoring System)
- Satellite communication system for VHMS
- Torque converter lock-up
- PM service connectors
- Radiator site gauge

### Attachments

- Front pull hook
- Wiper rear window

- Wiper front window
- Wipers doors
- Underguards, oil pan and transmission
- Lighting system, front
- Lighting system, rear
- Tool kit

### Engine related parts

- Radiator reserve tank
- Heavy-duty radiator mask
- Fuel tank inlet strainer
- Water separator
- Hard water area arrangement incl. corrosion resistor
- Poor fuel area arrangement
- Intake pipe with rain cap
- Dry type air cleaner, double element with dust indicator and evacuator
- Provision for fuel quick charge
- Locks, filter caps and covers
- Starter motor 24 V/7,5 kW

- Alternator 24 V/90 A
- Batteries 2 × 12 V/170 Ah
- Gull wing engine side covers
- Hydroshift transmission
- C&B wet steering system
- Auto-downshift function
- Quick shift selection system

### Work equipment

- Hydraulics for ripper
- Hydraulics for dozing blades

### Safety equipment

- Back-up alarm
- Warning horn
- Steel cab
- ROPS canopy, meets ISO 3471 and SAE J1040, APR88 ROPS standards, as well as ISO 3449 FOPS standard

## OPTIONAL EQUIPMENT

### Cab

- Radio-Cassette

### Undercarriage

- Single grouser heavy-duty shoes (710 mm, 810 mm)
- Final drive case wear guard
- Full length track roller guard for K-bogie

### Control systems

- Track shoe slip control system

### Engine related parts

- Electric type engine oil and coolant heater
- High-capacity batteries 2 × 12 V/220 Ah

### Attachments

- Hitch
- Counterweight
- Counterweight + hitch
- Ripper working light
- Inspection light

### Work equipment

- Semi-U blade single tilt 18,5 m<sup>3</sup>
- Semi-U blade dual tilt 18,5 m<sup>3</sup>
- Strengthened semi-U blade single tilt 18,5 m<sup>3</sup>
- Strengthened semi-U blade dual tilt 18,5 m<sup>3</sup>
- Strengthened U blade single tilt 22,0 m<sup>3</sup>
- Strengthened U blade dual tilt 22,0 m<sup>3</sup>
- Spill guard for semi-U dozer
- Spill guard for U dozer
- Push plate for semi-U dozer weld-on

- Multishank variable angle ripper
- Giant variable angle ripper

### Safety equipment

- Fire extinguisher
- First aid kit

Call the experts



**Komatsu Europe International NV**

Mechelsesteenweg 586  
B-1800 VILVOORDE (BELGIUM)  
Tel. +32-2-255 24 11  
Fax +32-2-252 19 81  
www.komatsueurope.com

EESS015305 05/2008

Materials and specifications are subject to change without notice.

**KOMATSU** is a trademark of Komatsu Ltd. Japan.

Printed in Europe – This specification sheet may contain attachments and optional equipment that are not available in your area. Please consult your local Komatsu distributor for those items you may require. Materials and specifications are subject to change without notice.

Courtesy of Machine.Market