



Volvo Construction Equipment

L60H, L70H, L90H

VOLVO WHEEL LOADERS 13.0-18.3 t / 24,250-38,140 lb 165-184 hp



A passion for performance.

At Volvo Construction Equipment, we're not just coming along for the ride. Developing products and services that raise productivity – we are confident we can lower costs and increase profits for customers around the globe. Part of the Volvo Group, we are passionate about innovative solutions to help you work smarter – not harder.

Helping you to do more

Doing more with less is a trademark of Volvo Construction Equipment. High productivity has long been married to low energy consumption, ease of use and durability. When it comes to lowering life-cycle costs, Volvo is in a class of its own.

Designed to fit your needs

There is a lot riding on creating solutions that are suited to the particular needs of different industry applications. Innovation often involves high technology – but it doesn't always have to. Some of our best ideas have been simple, based on a clear and deep understanding of our customers' working lives.



You learn a lot in 180 years

Over the years, Volvo has advanced solutions that have revolutionized the use of construction equipment. No other name speaks Safety louder than Volvo. Protecting operators, those around them and minimizing our environmental impact are traditional values that continue to shape our product design philosophy.

We're on your side

We back the Volvo brand with the best people. Volvo is truly a global enterprise, one that is on standby to support customers quickly and efficiently – wherever they are.

We have a passion for performance.

A strong, dedicated, capable dealer network.

Our dealers are strategically located throughout North America to provide the equipment you need and the parts and service support you demand for a productive and profitable operation.

The strength of our dealer network is enhanced with extensive individualized product support training at our best-in-class Customer Center in Shippensburg and through hands-on training. Using a great Product Demonstration Center featuring a dedicated area for most common applications, visitors operate equipment from our entire product line under a variety of simulated working conditions. This facility is in year-round use by our dealers and customers.

Building the best starts right here.

The products designed and manufactured by Volvo Construction Equipment have their beginnings at the most advanced Research & Design centers in the industry. Volvo CE machines are designed in 11 R&D centers and produced in 15 manufacturing facilities across the world.

The major R&D center and manufacturing plant in the Americas is located in Shippensburg, Pennsylvania. This facility has been in operation for over 30 years and – with its recently added 200,000 sq. ft. expansion – now covers 570,000 sq. ft. on an 80 acre campus. Dedicated work teams and highly advanced technologies and techniques using the Volvo Production System ensure continuous quality improvements, labor savings and cost control to reach the high quality that our customers have come to expect from Volvo.





Volvo Trucks



Renault Trucks



Mack Trucks



UD Trucks



Volvo Buses



Volvo Construction Equipment



Volvo Penta



Volvo Financial Services

See clearer in comfort.

The Volvo L60H, L70H and L90H wheel loaders are versatile machines that can take on any task with a wide range of perfectly matched attachments. From the comfort of your wheel loader, sit back and enjoy a clear view of the site while increasing your productivity and uptime.

HMI - New display and controls

Operator ergonomics is at the forefront of Volvo's HMI (Human Machine Interface) design. The information display, controls, setting switches, hydraulic control levers and steering wheel, are all designed and placed in the cab for easy and comfortable operation. The information display informs the operator about all necessary machine information for peace of mind, control and less fatigue. The new display has better visibility even when exposed to direct sunlight.



Seat

The operator's seat has several adjustment possibilities for maximum comfort. Suspension and damping are adjustable according to body weight and both the seat cushion and backrest can be positioned at various angles. Well placed instruments and adjustable lever console make your long day a lot more comfortable.



Heating, ventilation and air conditioning

The standard Automatic Heat Control (AHC) system ensures a comfortable environment inside the cab. Air conditioning is also available so the operator can work in comfortable conditions, in any climate.



Industry leading air-filtration

Volvo's industry-leading air filtration system allows 90% of the cab air to be recirculated through the main filter for continuous dust removal and a cleaner environment. The cab air intake is located in a high position where the air is cleaner. An easily replaceable external pre-filter effectively separates coarser dust and particles before entering the main filter and cab.



Cab

Volvo continues to provide the industry-leading cab for maximum comfort, visibility and productivity. The cab is consistent across all Volvo wheel loaders and boasts unparalleled all-round visibility, space, climate control, safety and vibration levels. The Volvo cab is also renowned for its effective sound proofing, protecting the operator from noise for a more productive environment.



TP linkage

The TP linkage combined with the new and improved Volvo attachment bracket offers industry leading versatility and unparalleled front visibility. The TP linkage combines the benefits of the Z-bar and parallel linkage to deliver high breakout torque and excellent parallel movement throughout the entire lifting range. The bracket allows attachments to be changed quickly and safely so the machine can perform a wide range of tasks.

An up-front approach.

The wheel loaders are especially designed to match a number of attachments so that you can handle a variety of tasks on your job site with the same machine. The TP linkage together with the improved Volvo attachment bracket provides excellent versatility and visibility.

Attachment Bracket

Want to switch between different attachments quickly and easily? Then look no further than the market-leading attachment bracket from Volvo Construction Equipment. The smart design of the interface enables safe connection to a wide range of attachments that meet the International Standardization Organization (ISO) standard.



Double sealed joints

The Volvo TP linkage features double sealed joints for all linkage pins. The double sealing system retains lubricating grease and prevents dust or other contaminants from getting in. The double sealing system results in a longer life for the lift arm system. The high quality and durable components last longer, reduce maintenance and increase uptime.



Roll back angle

The Volvo TP linkage geometry, along with the Volvo bucket design, provides excellent bucket roll-back angles. The superior roll-back angle increases the amount of retained material in the bucket and keeps the load closer to the front axle for increased stability and less spillage. As a result, the roll back angle increases productivity.



Parallel movement

The TP linkage allows excellent parallel movement, which means the load stays level throughout the entire lifting range. This allows the operator to have full control over the load, which increases safety and productivity.

A multiple of talents.

Volvo offers the most durable and effective Volvo attachments, which work in harmony with your machine for increased productivity and versatility. They are designed for improved visibility and ease of use, so you can swap and change your Volvo attachments quickly and safely.

New General Purpose (GP) bucket

The improved Volvo general purpose bucket is designed for higher productivity and increased fuel efficiency. The bucket – when fitted with bolt-on edges – handles loose material, such as gravel and aggregates in both short cycle or load and carry operations. It can be fitted with optional welded teeth and segments to load harder banked material with ease. It provides excellent support on your job site and the wear resistant steel is used in the most exposed areas for increased durability and long life.



Pallet forks

Volvo's pallet fork frame with pallet fork tines allow the machine to handle, load and move pallets of building material, drainage pipe, lumber, or loose items around the uneven terrain of a construction site. The Volvo pallet fork and attachment bracket has been designed for industry-leading visibility at different working heights while moving and lifting materials. Volvo's durable TP linkage, attachment bracket and pallet forks increase safety.

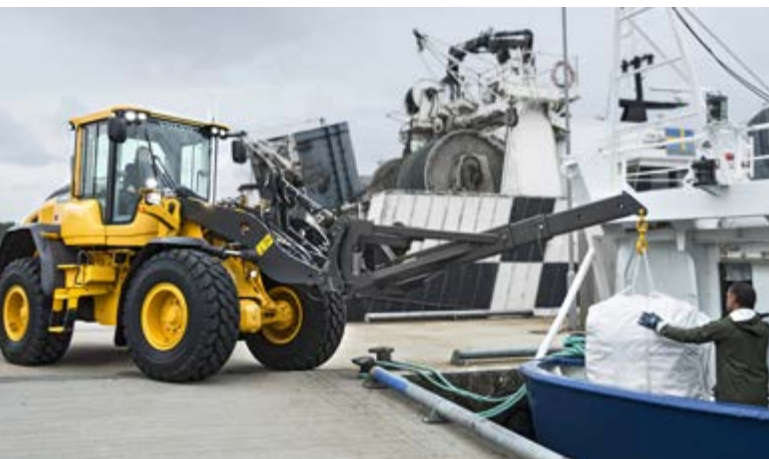

Material handling arm

Volvo's material handling arm extends your machine's versatility. Designed to work with Volvo wheel loaders and with an approved lift capacity set for each arm and machine, you'll know exactly how much you can lift safely. The extendable arm consists of three sections, providing increased flexibility and greater reach. Safety Mechanical stops also prevent the material handling arm from overextending – a safety hook at the end of the arm is fitted as standard.



Light Material (LM) bucket

The Volvo light material bucket with a robust light weight design and high capacity, secures the highest productivity for your machine. The bucket is designed for efficient handling low density material, such as snow, sawdust, wood chips and compost. It's delivered with a standard bolt-on edge.



Attachment offer

Volvo attachments give you more flexibility. Each attachment from the extensive range is perfectly matched to the machine's link-arm geometry and breakout, rim pull and lifting force. All attachments can be fastened and removed quickly thanks to Volvo's attachment bracket so you can 'connect and go'.

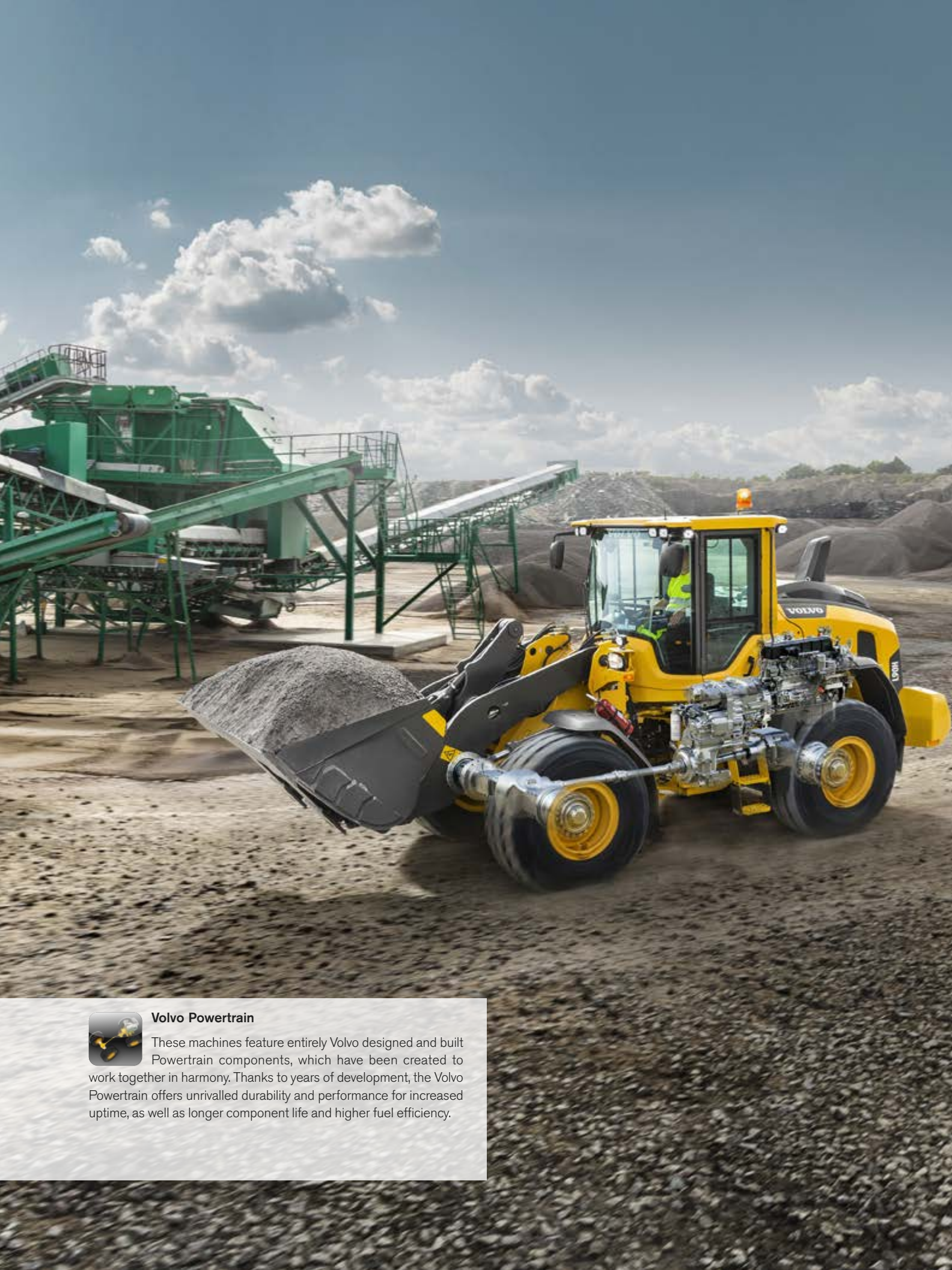

Volvo Powertrain

These machines feature entirely Volvo designed and built Powertrain components, which have been created to work together in harmony. Thanks to years of development, the Volvo Powertrain offers unrivalled durability and performance for increased uptime, as well as longer component life and higher fuel efficiency.

Made to last.

Quality is key at Volvo, which is why only the best components, technology and systems are used in the Volvo wheel loaders. All parts work with each other for increased reliability and a long cycle life, saving you long term costs and downtime.

Counter shaft transmission

The Volvo counter shaft transmission offers a heavy duty solution for proven reliability and durability. The machines are equipped with a counter shaft transmission that can endure more stress. Various tailored settings can be selected by the operator to match all applications whether it's short cycle truck loading or medium to long distance load and carry.



Axles

Volvo axles provide longer service life as a result of the free-floating shaft design, durable components, circulating lubrication oil and wet-disc brakes. The outboard service brakes are easily maintained for greater uptime and can also be easily monitored using the brake wear indicators.



Differential lock

The differential lock provide outstanding traction and rimpull on soft and slippery ground conditions. The front axle is mounted to the front frame and equipped with an electro-hydraulically operated differential lock. The differential lock is a dog-clutch type which can secure 100% locking, which minimizes wheel spin and tire wear.



Intelligent hydraulic system

The load sensing hydraulic system increases fuel efficiency and provides perfect control of the load. It also allows for more engine power to be available for rimpull, providing easier penetration for increased performance. With help from the variable displacement piston pumps and precision control levers, hydraulic power is delivered according to demand.

Strongly attached.

Environmental care is at the forefront of Volvo's core values and to show its passion and dedication, Volvo thinks about all aspects of the machine which can impact on the environment.

Tier 4 Final

Volvo's 6 litre diesel Tier 4 Final engine complies with the latest emissions legislation and delivers high torque at low engine rpm. The engine delivers industry-leading performance and impressive fuel efficiency.



Eco-pedal

This unique feature keeps operators aware of whether they are operating in the most economical way in order to increase fuel efficiency. The Eco-pedal with a mechanical push-back mechanism engages when the engine rpm is about to exceed the economic operating range. The operator senses the resistance and then operates within the optimal operating range. If full engine speed is needed, this mechanical push-back mechanism can easily be overridden.



Service access

The service friendly design keeps your routine maintenance quick and efficient. The one piece motorized engine hood opens up at a large angle, providing full access to the engine compartment and engine maintenance points are strategically grouped together for quick and easy service checks. The machine also features fluid drain ports which simplifies the oil changing. This prevents oil spillages that impacts the environment.



95% of the machine is recyclable

Planned recycling of the machine is the last stage of its life cycle. Being able to recycle machine parts and materials for use in new Volvo wheel loaders or other products is part of Volvo's responsibility to environmental care. According to our calculations, the machine is up to 95% recyclable by weight. Volvo thrives to build a sustainable environment and reuse parts whenever possible.



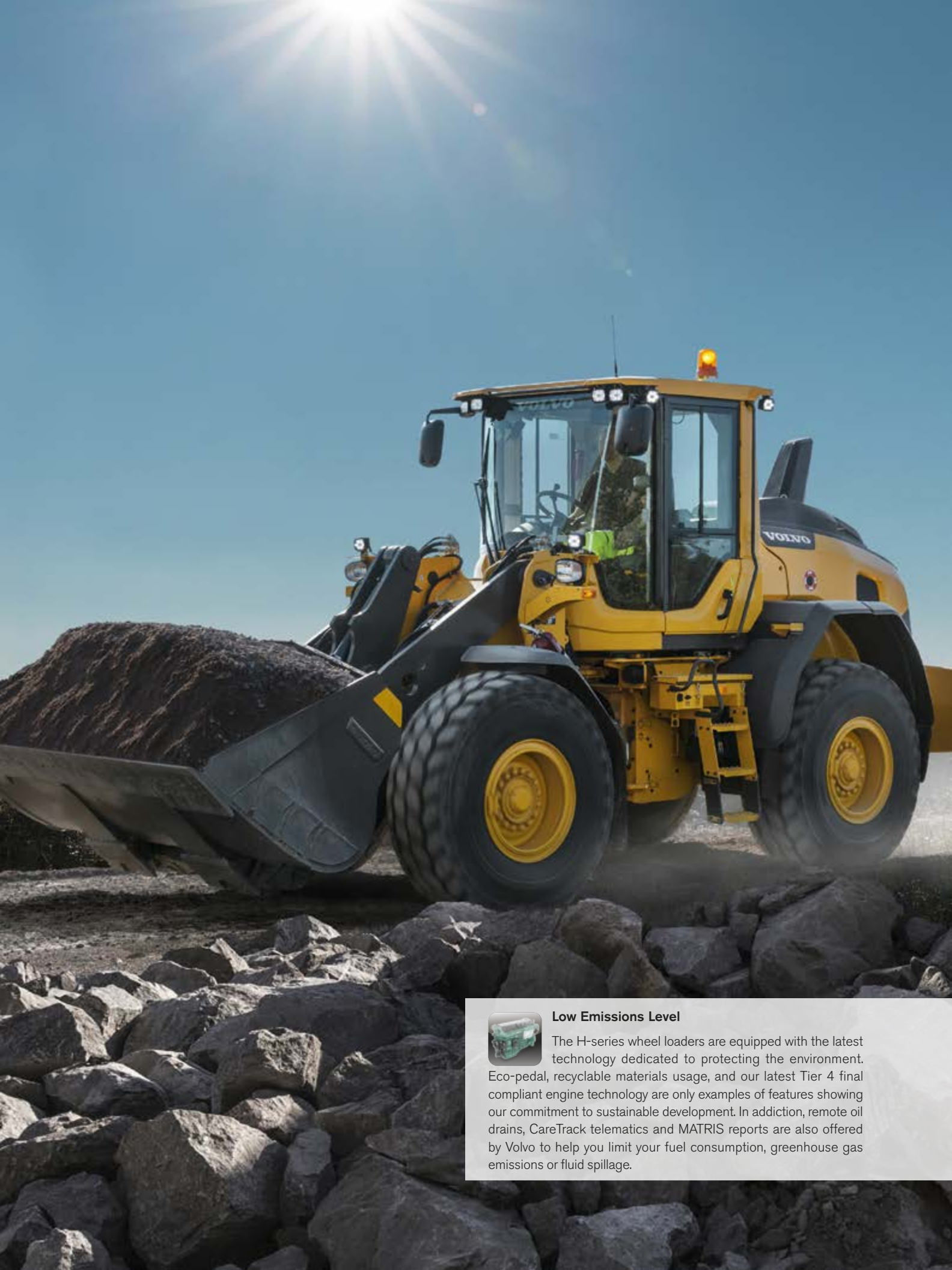

Low Emissions Level

The H-series wheel loaders are equipped with the latest technology dedicated to protecting the environment. Eco-pedal, recyclable materials usage, and our latest Tier 4 final compliant engine technology are only examples of features showing our commitment to sustainable development. In addition, remote oil drains, CareTrack telematics and MATRIS reports are also offered by Volvo to help you limit your fuel consumption, greenhouse gas emissions or fluid spillage.

An application for any occasion.



Cab

Volvo continues to provide the industry-leading cab for maximum comfort, visibility and productivity.

Human Machine Interface

The information display, controls, setting switches, hydraulic control levers and steering wheel, are all designed and placed in the cab for easy and comfortable operation.



TP linkage

The TP linkage combines the benefits of Z-bar and parallel linkage in one to deliver high breakout torque and excellent parallel movement through the entire lifting range.

Attachment bracket

The Volvo attachment bracket is the most commonly used attachment bracket in the world with a compact and robust design for outstanding visibility.



Attachment offer

Volvo's wide range of high quality attachments are perfectly matched to the machine's linkage, hydraulics and driveline to work as one unit and increase productivity.

Eco pedal

This unique feature keeps operators aware of whether they are operating in the most economical way in order to increase fuel efficiency.



Volvo Powertrain

These machines feature entirely Volvo designed and built Powertrain components, which have been created to work together in harmony.

Hydraulic cooling fan

Hydraulically driven, electronically controlled cooling fan, located between the engine and radiator, speeds-up only when necessary to lower fuel consumption and sound levels.

Tier 4 Final/Stage IV engine technology

Volvo's 6 litre diesel Tier 4 Final/ Stage IV engine complies with the latest emissions legislation and delivers high torque at low engine rpm.

Intelligent hydraulic system

The load sensing hydraulic system increases fuel efficiency and provides perfect control of the load.

Service access

The service friendly design increases your uptime by allowing easy access and quick service.

CareTrack*

CareTrack provides information for better planning and smarter working, including fuel consumption reports, location reports and service reminders.



Low Emissions Level

The wheel loaders are equipped with the latest technology dedicated to protecting the environment.



Lifetime Frame Warranty:

Find out more on volvoce.com/structureandframe

* In markets where CareTrack is available

Volvo L60H, L70H, L90H in detail.

Engine

6-cylinder, 6 liters in-line turbocharged diesel engine with an advanced fuel injection system with the common rail. Fuel is distributed under high pressure from a high-pressure accumulator, the rail. One belt driven high pressure pump deliver the fuel to the rail and then further on via high-pressure pipes to the electronically operated fuel injectors. Engine meets Tier 4 Final emission legislation.

L60H

Engine				D6J (Tier 4 Final)
Max power at	r/s (r/min)	23.3-30.0 (1,400-1,800)		
SAE J1995 gross	kW hp	123 165		
ISO 9249, SAE J1349 net	kW hp	123 165		
Max torque at	r/s (r/min)	23.3 (1,400)		
SAE J1995 gross	Nm lbf ft	820 605		
ISO 9249, SAE J1349 net	Nm lbf ft	820 605		
Economic working range	r/s (r/min)	13.3-26.6 (800-1,600)		
Displacement	l in ³	5.7 348		

L70H

Engine				D6J (Tier 4 Final)
Max power at	r/s (r/min)	23.3-28.3 (1,400-1,700)		
SAE J1995 gross	kW hp	127 170		
ISO 9249, SAE J1349 net	kW hp	127 170		
Max torque at	r/s (r/min)	23.3 (1,400)		
SAE J1995 gross	Nm lbf ft	853 629		
ISO 9249, SAE J1349 net	Nm lbf ft	853 629		
Economic working range	r/s (r/min)	13.3-26.6 (800-1,600)		
Displacement	l in ³	5.7 348		

L90H

Engine				D6J (Tier 4 Final)
Max power at	r/s (r/min)	23.3-31.7 (1,400-1,900)		
SAE J1995 gross	kW hp	137 184		
ISO 9249, SAE J1349 net	kW hp	137 184		
Max torque at	r/s (r/min)	23.3 (1,400)		
SAE J1995 gross	Nm lbf ft	934 689		
ISO 9249, SAE J1349 net	Nm lbf ft	934 689		
Economic working range	r/s (r/min)	13.3-26.6 (800-1,600)		
Displacement	l in ³	5.7 348		

L60H

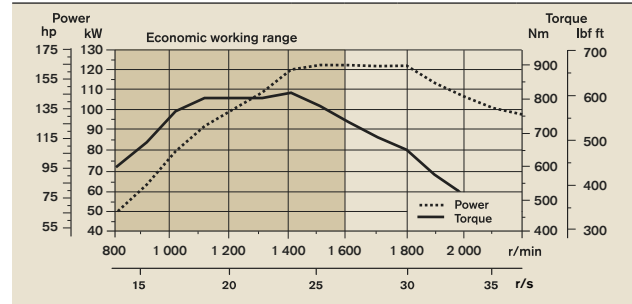

L70H

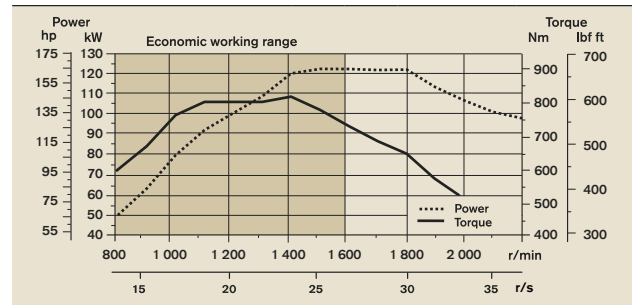

L90H

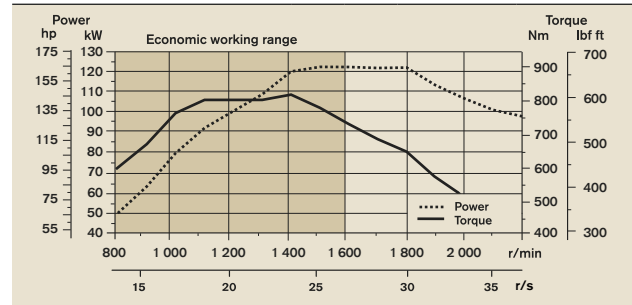

Drivetrain

Torque converter: Single-stage

Transmission: Volvo countershaft transmission with single lever control. Fast and smooth shifting of gears with Pulse Width Modulation (PWM) valve.

Transmission: Volvo Automatic Power Shift (APS) gear shifting system with fully automatic shifting 1-4 and mode selector with 4 different gear shifting programs, including AUTO mode.

Axles: Volvo fully floating axle shafts with planetary hub reductions and cast steel axle housing. Fixed front axle and oscillating rear axle. 100% differential lock on the front axle.

L60H

Transmission	Volvo	HTE 125	
Torque multiplication, stall ratio	2.5:1		
1st gear	km/h	mph	7 4.3
Maximum speed, forward/reverse	2nd gear	km/h	mph 14 8.7
	3rd gear	km/h	mph 27 16.8
	4th gear*	km/h	mph 44 27.3
Measured with tires	20.5R25		
Front axle/rear axle	AWB 15/AWB 15		
Rear axle oscillation ±	°		± 13
Ground clearance at 13° osc.	mm	in	470 18.5

L70H

Transmission	Volvo	HTE 125	
Torque multiplication, stall ratio	2.5:1		
1st gear	km/h	mph	7 4.3
Maximum speed, forward/reverse	2nd gear	km/h	mph 14 8.7
	3rd gear	km/h	mph 27 16.8
	4th gear*	km/h	mph 44 27.3
Measured with tires	20.5R25		
Front axle/rear axle	AWB 25/AWB 20		
Rear axle oscillation ±	°		± 13
Ground clearance at 13° osc.	mm	in	470 18.5

L90H

Transmission	Volvo	HTE 125	
Torque multiplication, stall ratio	2.5:1		
1st gear	km/h	mph	7 4.3
Maximum speed, forward/reverse	2nd gear	km/h	mph 13 8.1
	3rd gear	km/h	mph 25 15.5
	4th gear*	km/h	mph 44 27.3
Measured with tires	20.5R25		
Front axle/rear axle	AWB 25/AWB 20		
Rear axle oscillation ±	°		± 13
Ground clearance at 13° osc.	mm	in	470 18.5

*limited by ECU

Electrical system

Contronic electrical system with central warning light and buzzer for following functions:

- Serious engine fault, Low steering system pressure, Over speed warning engine, Interruption in communication (computer fault), Central warning light and buzzer with the gear engaged for the following functions: Low engine oil pressure, High engine oil temperature, High charge air temperature, Low coolant level, High coolant temperature, High crank case pressure, Low transmission oil pressure, High transmission oil temperature, Low brake pressure, Engaged parking brake, Fault on brake charging, Low hydraulic oil level, High hydraulic oil temperature, Overspeeding in engaged gear, High brake cooling oil temperature front and rear axles, etc.

L60H, L70H, L90H

Batteries	V	2 x 12
Battery capacity	Ah	2 x 110
Cold cranking capacity, approx	A	680
Alternator rating	W/A	3 135/80
Starter motor output	kW	5.5

Brake system

Service brake: Volvo dual-circuit system with outboard mounted, hydraulically operated, fully sealed and circulating oil cooled wet disc brakes. Operator selectable, four transmission de-clutch settings while braking.

Parking brake: Dry disc brake mounted on the transmission output shaft. Applied by spring force, electro-hydraulically released with a switch on the instrument panel.

Secondary brake: Dual brake circuits with rechargeable accumulators.

Standard: The brake system complies with the requirements of ISO 3450, 71/320/EEC

L60H

Number of brake discs per wheel front	1		
Accumulators	l	gal	3 x 0.5 3 x 0.13

L70H

Number of brake discs per wheel front	1		
Accumulators	l	gal	2 x 0.5 2 x 0.13 +1 x 1.0 +1 x 0.26

L90H

Number of brake discs per wheel front	1		
Accumulators	l	gal	2 x 0.5 2 x 0.13 +1 x 1.0 +1 x 0.26

Volvo L60H, L70H, L90H in detail.

Cab

Instrumentation: All important information is centrally located in the operator's field of vision. Display for Contronic monitoring system

Heater and defroster: Heater coil with filtered fresh air and fan with auto and 11 manual speed settings. Defroster vents for all window areas.

Operator's seat: Operator's seat with adjustable air suspension and retractable seat belt. The seat is mounted on a bracket on the rear cab wall and floor. The forces from the retractable seat belt are absorbed by the seat rails.

Standards: The cab is tested and approved according to ROPS (ISO 3471), FOPS (ISO 3449). The cab meets with requirements according to ISO 6055 (Operator overhead protection - Industrial trucks) and SAE J386 (Operator Restraint System).

		L60H	L70H	L90H
Emergency exit: Use emergency hammer to break window				
Sound level in cab according to ISO 6396/SAE J2105				
LpA	dB(A)	68	68	68
External sound level according to ISO 6396/SAE J2105				
LwA	dB(A)	104	105	105
Ventilation	m ³ /min yd ³ /min	9.0 11.8	9.0 11.8	9.0 11.8
Heating capacity	kW	16	16	16
Air conditioning (optional)	kW	7.5	7.5	7.5

Lift arm system

Torque parallel linkage (TP-linkage) with high breakout torque and parallel lift-arm action.

		L60H	L70H	L90H
Lift cylinders		2	2	2
Cylinder bore	mm in	110 4.3	110 4.3	120 4.7
Piston rod diameter	mm in	70 2.8	70 2.8	70 2.8
Stroke	mm in	665 26.2	756 29.8	733 28.9
Tilt cylinder		1	1	1
Cylinder bore	mm in	150 5.9	160 6.3	180 7.1
Piston rod diameter	mm in	80 3.1	90 3.5	90 3.5
Stroke	mm in	444 17.5	432 17.0	430 16.9

Service / Refill capacity

Service accessibility: Large, electrically operated easy-to-open hood covering whole engine compartment. Fluid filters and component breather air filters are located from ground level access and promote long service intervals. Machine contronics have possibility to monitor, log and analyze data to facilitate troubleshooting.

		L60H	L70H	L90H
Fuel tank	l gal	222 58.6	222 58.6	222 58.6
DEF tank	l gal	20 5.3	20 5.3	20 5.3
Engine coolant	l gal	30 7.9	30 7.9	30 7.9
Hydraulic oil tank	l gal	90 23.8	90 23.8	90 23.8
Transmission oil	l gal	21 5.5	21 5.5	21 5.5
Engine oil	l gal	19.5 5.2	19.5 5.2	19.5 5.2
Axle oil front	l gal	25 6.6	35 9.2	35 9.2
Axle oil rear	l gal	25 6.6	27 7.1	27 7.1

Hydraulic system

Closed center load sensing hydraulic system with non pressurised hydraulic tank and pilot operated control valves.

System supply: Variable displacement axial piston pump supply the hydraulic system.

Valves: The central valve distributes pressure and flow out to the cooling fan, steering, brake, pilot and hydraulic system. Steering system gets priority over others.

Lift function: The valve has four positions; raise, hold, lower and float position. Automatic boom kick-out position can be set to any position between maximum reach and full lifting height.

Tilt function: The valve has three functions; rollback, hold and dump. Automatic tilt-back can be adjusted to the desired bucket angle.

Cylinders: Double-acting cylinders for all functions.

Filter: Full flow filtration through 10 micron (absolute) filter cartridge.

			L60H	L70H	L90H
Working pressure maximum, pump 2 for steering-, brake-, pilot- and working hydraulic system	MPa bar		26.0 260	26.0 260	31 310
Flow	l/min gal/min		145 38.3	154 40.7	171 45.2
at	MPa bar		10 100	10 100	10 100
engine speed	r/s(r/min)		32 (1,900)	32 (1,900)	32 (1,900)
Working pressure maximum, pump 3 for brake- and cooling fan system	MPa bar		21.0 210	21.0 210	21.0 210
Flow	l/min gal/min		33 8.7	33 8.7	33 8.7
at	MPa bar		10 100	10 100	10 100
engine speed	r/s (r/min)		32 (1,900)	32 (1,900)	32 (1,900)
Pilot system, working pressure	MPa bar		3.5 35	3.5 35	3.5 35
Cycle times					
Lift	s		4.5	5.1	5.4
Tilt	s		2.3	1.3	1.9
Lower, empty	s		2.9	2.7	3.2
Total cycle time	s		9.7	9.1	10.5

Steering system

System supply: The steering system has priority feed from a load-sensing axial piston pump with variable displacement.

Steering cylinders: Two double-acting cylinders.

		L60H	L70H	L90H
Steering cylinders		2	2	2
Cylinder bore	mm in	70 2.76	70 2.76	80 3.1
Rod diameter	mm in	45 1.77	45 1.77	50 2.0
Stroke	mm in	386 15.2	386 15.2	345 13.6
Working pressure	MPa bar	21 210	21 210	21 210
Maximum flow	l/min gal/min	60 15.9	60 15.9	60 15.9
Maximum articulation	± °	40	40	40

Dimensions.

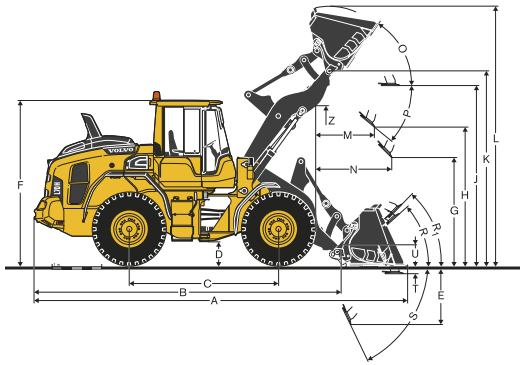

Where applicable, specifications and dimensions are according to ISO 7131, SAE J732, ISO 7546, SAE J742, ISO 14397, SAE J818.

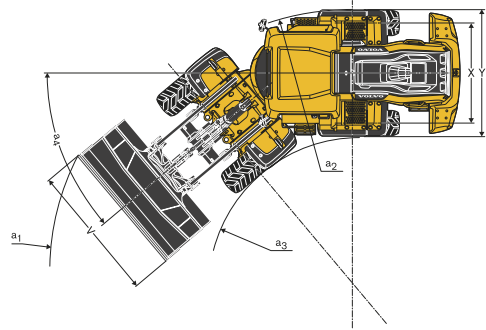

Tires 20.5 R25 L3

	Standard boom						Long boom							
	L60H		L70H		L90H		L60H		L70H		L90H			
B	mm	ft in	6 040	19' 10"	6 080	19' 11"	6 160	20' 3"	6 550	21' 6"	6 560	21' 6"	6 590	21' 8"
C	mm	ft in	3 000	9' 10"	3 000	9' 10"	3 050	10' 0"	3 000	9' 10"	3 000	9' 10"	3 050	10' 0"
D	mm	ft in	440	1' 5"	450	1' 6"	450	1' 6"	440	1' 5"	450	1' 6"	450	1' 6"
F	mm	ft in	3 270	10' 9"	3 280	10' 9"	3 280	10' 9"	3 270	10' 9"	3 280	10' 9"	3 280	10' 9"
G	mm	ft in	2 134	7' 0"	2 134	7' 0"	2 132	7' 0"	2 134	7' 0"	2 134	7' 0"	2 132	7' 0"
J	mm	ft in	3 570	11' 9"	3 590	11' 9"	3 660	12' 0"	4 150	13' 7"	4 100	13' 6"	4 090	13' 5"
K	mm	ft in	3 870	12' 8"	3 870	12' 9"	3 970	13' 0"	4 380	14' 4"	4 390	14' 5"	4 400	14' 5"
O	°		56		56		57		58		52		57	
Pmax	°		46		46		44		42		43		45	
R	°		43		43		44		43		43		46	
R ₁ *	°		47		48		49		50		49		51	
S	°		79		68		67		78		73		66	
T	mm	ft in	103	0' 4"	101	0' 4"	107	0' 4"	79	0' 3"	107	0' 4"	102	0' 4"
U	mm	ft in	450	1' 6"	440	1' 3"	470	1' 6.5"	540	1' 9"	500	1' 8"	510	1' 8"
X	mm	ft in	1 900	6' 3"	1 930	6' 4"	1 960	6' 5"	1 900	6' 3"	1 930	6' 4"	1 960	6' 5"
Y	mm	ft in	2 430	8' 0"	2 460	8' 1"	2 490	8' 2"	2 430	8' 0"	2 460	8' 1"	2 490	8' 2"
Z	mm	ft in	3 210	10' 6"	3 160	10' 4"	3 290	10' 9"	3 590	11' 10"	3 500	11' 6"	3 660	12' 0"
a ₂	mm	ft in	5 340	17' 6"	5 350	17' 7"	5 430	17' 10"	5 340	17' 6"	5 350	17' 7"	5 430	17' 10"
a ₃	mm	ft in	2 900	9' 6"	2 890	9' 6"	2 950	9' 8"	2 900	9' 6"	2 890	9' 6"	2 950	9' 8"
a ₄	±°		40		40		40		40		40		40	

Tires: 20.5R25 L3

			L60H		L70H		L90H	
Grapple sales code			82194		80153		80832	
SAE-Load	kg	lb	3 450	7,610	3 990	8,800	4 600	10,140
Operating weight without load*	kg	lb	12 380	27,310	14 110	31,110	16 100	35,510
A	m ²	yd ²	1.3	14	1.5	16.1	2.4	25.8
B	mm	ft in	3 410	11' 2"	3 380	11' 1"	3 420	11' 3"
C	mm	ft in	1 480	4' 10"	1 590	5' 3"	1 790	5' 11"
D	mm	ft in	2 930	9' 7"	2 870	9' 5"	2 790	9' 2"
E	mm	ft in	1 170	3' 10"	1 260	4' 2"	1 410	4' 7"
F	mm	ft in	1 530	5' 0"	1 510	4' 11"	1 440	4' 9"
G	mm	ft in	2 350	7' 8"	2 440	8' 0"	2 740	9' 0"
H	mm	ft in	4 330	14' 3"	4 380	14' 5"	4 540	14' 11"
I	mm	ft in	5 880	19' 3"	6 030	19' 9"	6 590	21' 7"
J	mm	ft in	2 000	6' 7"	2 140	7' 0"	2 790	9' 2"
K	mm	ft in	2 080	6' 10"	2 370	7' 9"	2 990	9' 10"
L	mm	ft in	1 710	5' 7"	1 790	5' 11"	2 130	7' 0"
M	mm	ft in	7 890	25' 11"	7 990	26' 2"	8 460	27' 9"

* Including logging counterweight

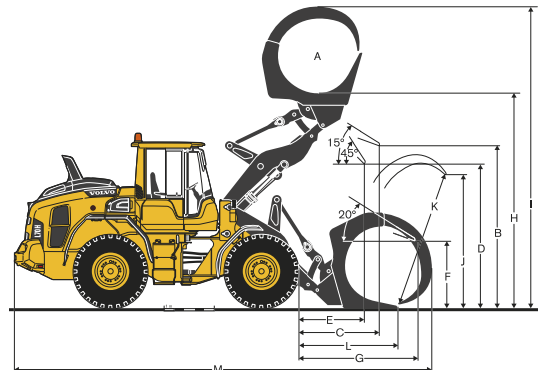

Dimensions.

Tires: 20.5R25 L3

			L60H		L70H		L90H			
MHA sales code			92007		92007		92008			
A*	kg	lb	1 800	3,969	2 150	4,741	2 760	6,086		
B*	kg	lb	1 400	3,087	1 710	3,771	2 130	4,697		
C*	kg	lb	1 150	2,536	1 400	3,087	1 740	3,837		
Static tipping load, straight			kg	lb	3 070	6,780	3 430	7,560	4 080	9,000
35deg. turn			kg	lb	2 760	6,090	3 090	6,800	3 650	8,040
at full turn			kg	lb	2 670	5,880	2 980	6,580	3 520	7,760
D	mm	ft in	2 590	8' 6"	2 710	8' 11"	2 610	8' 7"		
E	mm	ft in	2 000	6' 7"	2 100	6' 11"	2 010	6' 7"		
F	mm	ft in	1 460	4' 10"	1 540	5' 1"	1 410	4' 7"		
G	mm	ft in	3 270	10' 9"	3 320	10' 11"	3 250	10' 8"		
H	mm	ft in	4 300	14' 1"	4 350	14' 3"	4 380	14' 5"		
I	mm	ft in	5 430	17' 10"	5 490	18' 0"	5 520	18' 1"		
J	mm	ft in	900	2' 11"	1 260	4' 2"	1 340	4' 5"		
K	mm	ft in	1 220	4' 0"	1 740	5' 9"	1 890	6' 2"		
L	mm	ft in	1 580	5' 2"	2 260	7' 5"	2 430	8' 0"		
M	mm	ft in	2 260	7' 5"	2 170	7' 2"	2 040	6' 8"		
N	mm	ft in	3 240	10' 8"	3 090	10' 2"	3 030	9' 11"		
O	mm	ft in	4 320	14' 2"	4 100	13' 5"	4 020	13' 2"		
P	mm	ft in	1 510	4' 11"	1 530	5' 0"	1 530	5' 0"		
Q	mm	ft in	5 290	17' 4"	5 300	17' 5"	5 340	17' 6"		
R	mm	ft in	6 170	20' 3"	6 180	20' 3"	6 300	20' 8"		
S	mm	ft in	7 140	23' 5"	7 130	23' 5"	7 260	23' 10"		

Operating weight without load kg lb 11 670 25,720 13 160 29,020 14 520 32,010

* Op. load at full turn + tipping position

Tipping loads calculated for max. arm length

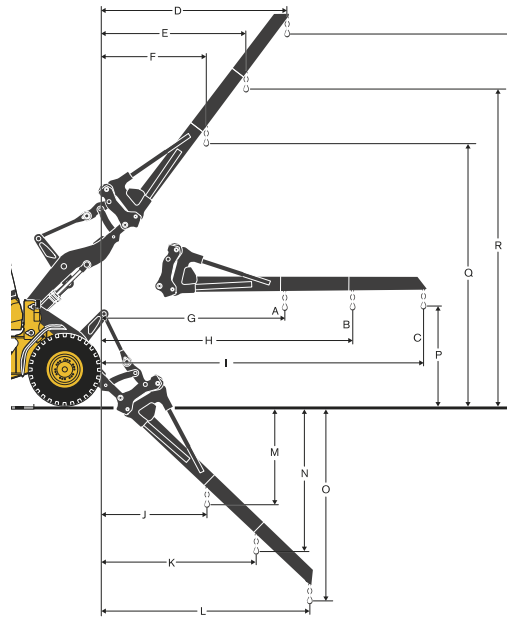

Tires: 20.5R25 L3





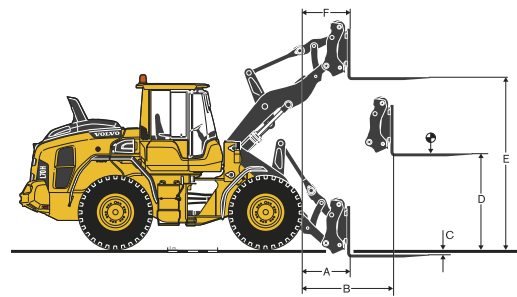





			L60H		L70H		L90H			
Fork frame sales code			83 768		83 769		83770			
Fork tines sales code (R/L)			80042/80043		80042/80044		80106/80107			
Static tipping load, straight			kg	lb	6 570	14,490	7 250	15,990	8 470	18,670
35deg. Turn			kg	lb	5 900	13,020	6 510	14,370	7 550	16,650
at full turn			kg	lb	5 710	12,580	6 300	13,890	7 280	16,050
at load center distance*			mm	in	600	2' 0"	600	2' 0"	600	2' 0"
A	mm	ft in	790	2' 7"	840	2' 9"	930	3' 1"		
B	mm	ft in	1 560	5' 2"	1 610	5' 3"	1 670	5' 6"		
C	mm	ft in	-37	-0' 1.5"	-55	-0' 2.1"	-8	-0' 0.3"		
D	mm	ft in	1 830	6' 0"	1 860	6' 1"	1 800	5' 11"		
E	mm	ft in	3 710	12' 2"	3 740	12' 3"	3 780	12' 5"		
F	mm	ft in	700	2' 3"	760	2' 6"	730	2' 5"		
Operating weight without load			kg	lb	11 750	25,900	13 240	29,200	14 610	32,220

* Firm and level ground







Specifications.

L60H

Tires 20.5R25 XHA2 L3	GENERAL PURPOSE										GRADING		LIGHT MATERIAL			LONG BOOM	
																	
	1.9 m ³ 2.5 yd ³ STE H BOE	1.8 m ³ 2.4 yd ³ STE H T	2.1 m ³ 2.7 yd ³ STE P BOE	2.1 m ³ 2.7 yd ³ STE H BOE	2.3 m ³ 3.0 yd ³ STE P BOE	2.3 m ³ 3.0 yd ³ STE H BOE	1.7 m ³ 2.2 yd ³ GRB H BOE	3.1 m ³ 4.1 yd ³ LM H	5.0 m ³ 6.5 yd ³ LM H								
Volume, heaped ISO/SAE	m ³ yd ³	1.9 2.5	1.8 2.4	2.1 2.7	2.1 2.7	2.3 3	2.3 3	1.7 2.2	3.1 4.1	5 6.5	-	-					
Volume at 110% fill factor	m ³ yd ³	2.1 2.7	2 2.6	2.3 3	2.3 3	2.5 3.3	2.5 3.3	1.9 2.4	3.4 4.5	5.5 7.2	-	-					
Static tipping load, straight at 35° turn	kg lb	8 460 18,650	8 630 19,030	8 820 19,450	8 370 18,460	8 740 19,270	8 290 18,280	7 320 16,150	7 990 17,610	7 970 17,580	-1710 -3,770	-					
at full turn	kg lb	7 560 16,660	7 720 17,020	7 900 17,420	7 470 16,470	7 820 17,250	7 390 16,290	6 540 14,430	7 110 15,690	7 070 15,590	-1570 -3,460	-					
Breakout force	kN lbf	81.9 18,410	83.9 18,870	84.9 19,090	78.5 17,650	80.9 18,200	75.1 16,900	60.2 13,540	61.7 13,880	53.8 12,100	2 390						
A	mm ft in	7 350 24' 1"	7 380 24' 3"	7 310 24' 0"	7 410 24' 4"	7 370 24' 2"	7 470 24' 6"	7 690 25' 3"	7 720 25' 4"	7 940 26' 1"	520 1' 8"						
E	mm ft in	1 120 3' 8"	1 140 3' 9"	1 080 3' 7"	1 180 3' 10"	1 140 3' 9"	1 230 4' 0"	1 400 4' 7"	1 480 4' 10"	1 700 5' 7"	30 0' 1"						
H	mm ft in	2 830 9' 3"	3 040 10' 0"	2 840 9' 4"	2 790 9' 2"	2 800 9' 2"	2 750 9' 0"	2 510 8' 3"	2 570 8' 5"	2 430 8' 0"	540 1' 9"						
L	mm ft in	5 020 16' 6"	5 020 16' 6"	4 800 15' 9"	5 100 16' 9"	5 120 16' 9"	5 170 17' 0"	4 520 14' 10"	5 280 17' 4"	5 480 18' 0"	520 1' 8"						
M	mm ft in	1 050 3' 6"	1 400 4' 7"	990 3' 3"	1 090 3' 7"	1 040 3' 5"	1 130 3' 9"	1 130 3' 8"	1 310 4' 3"	1 500 4' 11"	0 0						
N	mm ft in	1 570 5' 2"	2 030 6' 8"	1 560 5' 1"	1 590 5' 3"	1 580 5' 2"	1 600 5' 3"	1 480 4' 10"	1 620 5' 4"	1 670 5' 6"	450 1' 6"						
V	mm in	2 500 98"	2 500 98"	2 500 98"	2 500 98"	2 500 98"	2 500 98"	2 500 98"	2 550 100"	2 650 104"	0 0						
a, clearance circle	mm ft in	11 570 37' 11"	11 620 38' 2"	11 580 38' 0"	11 600 38' 1"	11 610 38' 1"	11 620 38' 2"	11 970 39' 3"	11 840 38' 10"	12 060 39' 7"	440 1' 5"						
Operating weight	kg lb	12 100 26,670	12 040 26,540	11 870 26,170	12 150 26,800	11 900 26,250	12 200 26,900	12 040 26,550	12 230 26,970	12 520 27,610	120 260						

Bucket Selection Chart

The chosen bucket is determined by the density of the material and the expected bucket fill factor. The actual bucket volume is often larger than the rated capacity, due to the features of the TP linkage, including an open bucket design, good rollback angles in all positions and good bucket filling performance. The example represents a standard boom configuration.
 Example: Sand and gravel. Fill factor ~ 105%. Density 1.6 t/m³ (2,700 lb/yd³).
 Result: The 3.4 m³ (4.5 yd³) bucket carries 3.6 m³ (4.7 yd³). For optimum stability always consult the bucket selection chart.

Material	Bucket fill, %		Material density		ISO/SAE bucket volume		Actual volume	
			t/m ³	lb/yd ³	m ³	yd ³	m ³	yd ³
Earth/Clay	~ 110		~ 1.55	~ 2,610	1.9	2.5	2.1	2.8
			~ 1.40	~ 2,360	2.1	2.8	2.3	3.0
			~ 1.30	~ 2,190	2.3	3.0	2.5	3.3
Sand/Gravel	~ 105		~ 1.65	~ 2,780	1.9	2.5	2.0	2.6
			~ 1.50	~ 2,530	2.1	2.8	2.2	2.9
			~ 1.35	~ 2,280	2.3	3.0	2.1	2.8
Aggregate	~ 100		~ 1.75	~ 2,950	1.9	2.5	1.9	2.5
			~ 1.55	~ 2,610	2.1	2.8	2.1	2.8
			~ 1.55	~ 2,610	2.3	3.0	2.3	3.0
Rock	≤ 100		~ 1.70	~ 2,870	1.7	2.2	1.7	2.2

The size of rock buckets is optimized for optimal penetration and filling capability rather than the density of the material.

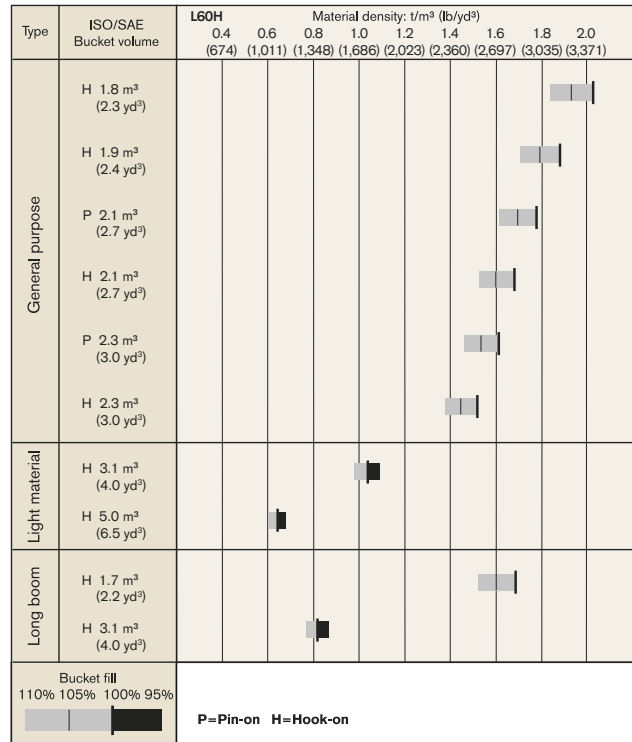













How to read bucket fill factor

Supplemental Operating Data

Tires 20.5 R25 L2	Standard boom						
		17.5 R25 L2	20.5 R25 L2	600/65 R25 L3			
Width over tires	mm in	-122 -4.8	+10 +0.4	+100	+4		
Ground clearance	mm in	-72 -2.8	-10 -0.4	-30	-1.2		
Tipping load, full turn	kg lb	-328 -723	-120 -265	-20	-44		
Operating weight	kg lb	-589 -1,299	-90 -198	+30	+66		





Specifications.

L70H

Tires 20.5R25 XHA2 L3		GENERAL PURPOSE												GRADING		LIGHT MATERIAL		LONG BOOM	
																			
		2.1 m³ 2.7 yd³ STE H BOE	2.0 m³ 2.6 yd³ STE H T	2.3 m³ 3.0 yd³ STE P BOE	2.3 m³ 3.0 yd³ STE H BOE	2.4 m³ 3.1 yd³ STE P BOE	2.4 m³ 3.1 yd³ STE H BOE	2.2 m³ 2.9 yd³ GRB H BOE	3.4 m³ 4.4 yd³ LM H	6.4 m³ 8.4 yd³ LM H									
Volume, heaped ISO/SAE	m³ yd³	2.1 2.7	2.0 2.6	2.3 3.0	2.3 3.0	2.4 3.1	2.4 3.1	2.2 2.9	3.4 4.4	6.4 8.4	-	-							
Volume at 110% fill factor	m³ yd³	2.3 3.0	2.2 2.9	2.5 3.3	2.5 3.3	2.6 3.5	2.6 3.5	2.4 3.2	3.7 4.9	7.0 9.2	-	-							
Static tipping load, straight	kg lb	9 330 20,570	9 520 20,990	9 860 21,750	9 270 20,430	9 830 21,670	9 230 20,350	7 550 16,650	8 820 19,450	8 380 18,480	-1 740	-3,840							
at 35° turn	kg lb	8 340 18,380	8 520 18,790	8 840 19,490	8 280 18,250	8 800 19,410	8 240 18,170	6 700 14,780	7 850 17,320	7 390 16,290	-1 600	-3,520							
at full turn	kg lb	8 040 17,730	8 230 18,140	8 540 18,820	7 980 17,600	8 500 18,740	7 950 17,520	6 460 14,230	7 570 16,690	7 090 15,640	-1 550	-3,410							
Breakout force	kN lbf	92.8 20,860	94.8 21,320	98.8 22,210	89.4 20,110	96.5 21,700	87.6 19,690	62.7 14,100	71.7 16,130	53.9 12,110	-2.0	-380							
A	mm ft in	7 440 24' 5"	7 590 24' 11"	7 370 24' 2"	7 490 24' 7"	7 400 24' 3"	7 520 24' 8"	7 950 26' 1"	7 780 25' 6"	8 330 27' 4"	460	1' 6"							
E	mm ft in	1 150 3' 9"	1 290 4' 3"	1 080 3' 7"	1 190 3' 11"	1 110 3' 8"	1 220 4' 0"	1 670 5' 6"	1 470 4' 10"	1 970 6' 5"	20	0' 1"							
H	mm ft in	2 780 9' 2"	2 690 8' 10"	2 830 9' 3"	2 750 9' 0"	2 810 9' 2"	2 730 8' 11"	2 350 7' 9"	2 530 8' 4"	2 150 7' 1"	560	1' 10"							
L	mm ft in	5 100 16' 9"	5 150 16' 11"	5 090 16' 9"	5 170 16' 11"	5 130 16' 10"	5 200 17' 1"	4 720 15' 6"	5 450 17' 11"	5 790 19' 0"	510	1' 8"							
M	mm ft in	1 110 3' 8"	1 240 4' 1"	1 060 3' 6"	1 140 3' 9"	1 070 3' 6"	1 160 3' 10"	1 350 4' 5"	1 340 4' 5"	1 720 5' 8"	-60	-0' 2"							
N	mm ft in	1 630 5' 4"	1 710 5' 7"	1 610 5' 3"	1 650 5' 5"	1 610 5' 4"	1 660 5' 5"	1 570 5' 2"	1 680 5' 6"	1 720 5' 8"	400	1' 4"							
V	mm in	2 650 104"	2 500 98"	2 650 104"	2 650 104"	2 650 104"	2 650 104"	2 650 104"	2 650 104"	2 750 108"	0	0							
a, clearance circle	mm ft in	11 760 38' 7"	11 710 38' 5"	11 740 38' 6"	11 790 38' 8"	11 740 38' 6"	11 800 38' 9"	12 320 40' 5"	11 980 39' 4"	12 410 40' 9"	390	1' 3"							
Operating weight	kg lb	13 700 30,210	13 610 30,010	13 450 29,660	13 730 30,280	13 470 29,700	13 750 30,320	13 990 30,850	13 940 30,740	14 480 31,940	190	420							

Bucket Selection Chart

The chosen bucket is determined by the density of the material and the expected bucket fill factor. The actual bucket volume is often larger than the rated capacity, due to the features of the TP linkage, including an open bucket design, good rollback angles in all positions and good bucket filling performance. The example represents a standard boom configuration. Example: Sand and gravel. Fill factor ~ 105%. Density 1.65 t/m³ (2,780 lb/yd³). Result: The 2.5 m³ (3.3 yd³) bucket carries 2.6 m³ (3.4 yd³). For optimum stability always consult the bucket selection chart.

Material	Bucket fill, %	Material density		ISO/SAE bucket volume		Actual volume		
		t/m³	lb/yd³	m³	yd³	m³	yd³	
Earth/Clay	~ 110		~ 1.55	~ 2,610	2.5	3.3	2.7	3.5
			~ 1.45	~ 2,440	2.6	3.4	2.9	3.8
			~ 1.40	~ 2,360	2.8	3.7	3.1	4.0
Sand/Gravel	~ 105		~ 1.65	~ 2,780	2.5	3.3	2.6	3.4
			~ 1.55	~ 2,610	2.6	3.4	2.7	3.5
			~ 1.50	~ 2,530	2.8	3.7	2.9	3.7
Aggregate	~ 100		~ 1.75	~ 2,950	2.5	3.3	2.5	3.3
			~ 1.65	~ 2,780	2.6	3.4	2.6	3.4
			~ 1.60	~ 2,700	2.8	3.7	2.8	3.7
Rock	≤ 100		~ 1.80	~ 3,030	2.2	2.9	2.2	2.9

The size of rock buckets is optimized for optimal penetration and filling capability rather than the density of the material.











Type	ISO/SAE Bucket volume	L70H Material density: t/m³ (lb/yd³)																				
		0.4 (674)	0.6 (1,011)	0.8 (1,348)	1.0 (1,686)	1.2 (2,023)	1.4 (2,360)	1.6 (2,697)	1.8 (3,035)	2.0 (3,371)												
General purpose	H 2.0 m³ (2.6 yd³)																					
	H 2.1 m³ (2.7 yd³)																					
	P 2.3 m³ (3.0 yd³)																					
	H 2.3 m³ (3.0 yd³)																					
	P 2.4 m³ (3.1 yd³)																					
	H 2.4 m³ (3.1 yd³)																					
Light material	H 3.4 m³ (4.4 yd³)																					
	H 6.4 m³ (8.3 yd³)																					
Long boom	H 2.1 m³ (2.7 yd³)																					
	H 3.4 m³ (4.4 yd³)																					

How to read bucket fill factor

Supplemental Operating Data





Tires 20.5 R25 L2	Standard boom					
	20.5 R25 L2		600/65 R25 L3			
Width over tires	mm	in	+10	+0.4	+100	+4
Ground clearance	mm	in	-20	-0.8	-30	-1.2
Tipping load, full turn	kg	lb	-180	-397	-10	-22
Operating weight	kg	lb	-90	-198	+30	+66

L90H

Tires 20.5R25 XHA2 L3	GENERAL PURPOSE										GRADING		LIGHT MATERIAL		LONG BOOM						
																					
	2.3 m³ 3.0 yd³ STE H BOE	2.5 m³ 3.3 yd³ STE H T	2.5 m³ 3.3 yd³ STE P BOE	2.5 m³ 3.3 yd³ STE H BOE	2.6 m³ 3.4 yd³ STE P BOE	2.8 m³ 3.7 yd³ STE H BOE	2.8 m³ 3.7 yd³ GRB H BOE	4.1 m³ 5.4 yd³ LM H	7.0 m³ 9.2 yd³ LM H												
Volume, heaped ISO/SAE	m ³	2.3	3.0	2.5	3.3	2.5	3.3	2.5	3.3	2.6	3.4	2.8	3.7	2.8	3.7	4.1	5.4	7.0	9.2	-	-
Volume at 110% fill factor	m ³	2.5	3.3	2.8	3.6	2.8	3.6	2.8	3.6	2.9	3.7	3.1	4	3.1	4	4.5	5.9	7.7	10.1	-	-
Static tipping load, straight	kg	10,930	24,110	11,090	24,450	11,470	25,290	10,860	23,940	11,430	25,210	11,350	25,020	10,740	23,690	10,240	22,570	9,940	21,920	-1,680	-3,710
at 35° turn	kg	9,700	21,380	9,850	21,710	10,200	22,480	9,620	21,220	10,160	22,410	10,080	22,220	9,510	20,970	9,030	19,910	8,720	19,220	-1,530	-3,370
at full turn	kg	9,330	20,580	9,480	20,900	9,820	21,660	9,260	20,420	9,790	21,580	9,700	21,400	9,150	20,170	8,670	19,130	8,360	18,430	-1,490	-3,270
Breakout force	kN	138	31,020	137.6	30,940	145.5	32,720	133	29,900	142.9	32,120	137.7	30,960	126.4	28,420	100.5	22,590	86.9	19,540	2.0	390
A	mm	7,560	24' 10"	7,790	25' 7"	7,510	24' 7"	7,610	25' 0"	7,530	24' 8"	7,580	24' 10"	7,690	25' 3"	8,040	26' 4"	8,340	27' 4"	410	1' 4"
E	mm	1,170	3' 10"	1,370	4' 6"	1,110	3' 8"	1,210	4' 0"	1,140	3' 9"	1,180	3' 10"	1,280	4' 2"	1,590	5' 3"	1,850	6' 1"	-10	-0.4"
H	mm	2,840	9' 4"	2,700	8' 10"	2,880	9' 6"	2,810	9' 3"	2,870	9' 5"	2,830	9' 4"	2,750	9' 0"	2,540	8' 4"	2,340	7' 8"	430	1' 5"
L	mm	5,230	17' 2"	5,320	17' 6"	5,220	17' 2"	5,290	17' 4"	5,250	17' 3"	5,310	17' 5"	5,380	17' 8"	5,570	18' 3"	5,770	18' 11"	420	1' 5"
M	mm	1,070	3' 6"	1,270	4' 2"	1,030	3' 5"	1,110	3' 8"	1,050	3' 5"	1,080	3' 7"	1,140	3' 9"	1,440	4' 9"	1,650	5' 5"	-30	-0' 1"
N	mm	1,660	5' 5"	1,760	5' 9"	1,640	5' 4"	1,680	5' 6"	1,640	5' 5"	1,660	5' 5"	1,700	5' 7"	1,710	5' 7"	1,710	5' 7"	360	1' 2"
V	mm	2,750	108"	2,750	108"	2,750	108"	2,750	108"	2,750	108"	2,750	108"	2,750	108"	2,750	108"	3,000	118"	0	0
a, clearance circle	mm	12,040	39' 6"	12,170	39' 11"	12,010	39' 5"	12,060	39' 7"	12,020	39' 5"	12,050	39' 6"	12,100	39' 8"	12,300	40' 4"	12,700	41' 8"	310	1' 0"
Operating weight	kg	15,190	33,500	15,140	33,380	14,980	33,030	15,230	33,590	15,000	33,070	15,050	33,190	15,300	33,740	15,560	34,310	15,990	35,260	170	370

Bucket Selection Chart

The chosen bucket is determined by the density of the material and the expected bucket fill factor. The actual bucket volume is often larger than the rated capacity, due to the features of the TP linkage, including an open bucket design, good rollback angles in all positions and good bucket filling performance. The example represents a standard boom configuration.
 Example: Sand and gravel. Fill factor ~ 105%. Density 1.6 t/m³ (2,700 lb/yd³).
 Result: The 3.4 m³ (4.5 yd³) bucket carries 3.6 m³ (4.7 yd³). For optimum stability always consult the bucket selection chart.

Material	Bucket fill, %		Material density		ISO/SAE bucket volume		Actual volume	
			t/m ³	lb/yd ³	m ³	yd ³	m ³	yd ³
Earth/Clay	~ 110		~ 1.55	~ 2,610	2.5	3.3	2.7	3.5
			~ 1.45	~ 2,440	2.6	3.4	2.9	3.8
			~ 1.40	~ 2,360	2.8	3.7	3.1	4.0
Sand/Gravel	~ 105		~ 1.65	~ 2,780	2.5	3.3	2.6	3.4
			~ 1.55	~ 2,610	2.6	3.4	2.7	3.5
			~ 1.50	~ 2,530	2.8	3.7	2.9	3.7
Aggregate	~ 100		~ 1.75	~ 2,950	2.5	3.3	2.5	3.3
			~ 1.65	~ 2,780	2.6	3.4	2.6	3.4
			~ 1.60	~ 2,700	2.8	3.7	2.8	3.7
Rock	≤ 100		~ 1.80	~ 3,030	2.2	2.9	2.2	2.9

The size of rock buckets is optimized for optimal penetration and filling capability rather than the density of the material.

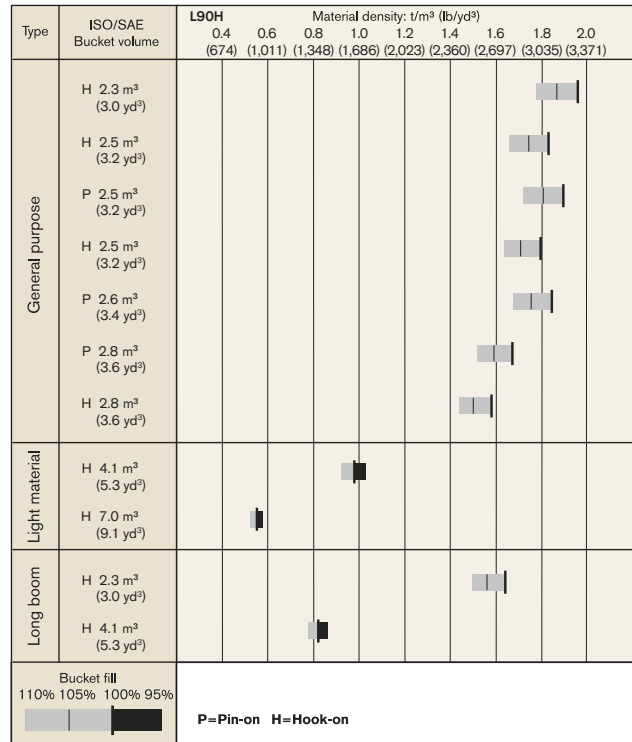

How to read bucket fill factor

Supplemental Operating Data

Tires 20.5 R25 L2	Standard boom					
	20.5 R25 L2		600/65 R25 L3			
Width over tires	mm	in	0	0	+160	+6.3
Ground clearance	mm	in	-10	-0.4	-10	-0.4
Tipping load, full turn	kg	lb	-110	-243	+310	+683
Operating weight	kg	lb	-100	-220.5	+560	+1,235

Equipment.

STANDARD EQUIPMENT

	L60H	L70H	L90H
Service and maintenance			
Engine oil remote drain and fill	•	•	•
Transmission oil remote drain and fill	•	•	•
Lubrication manifolds, ground accessible	•	•	•
Pressure test ports: transmission and hydraulic, quick connects	•	•	•
Service platforms with anti-slip surfaces	•	•	•
CareTrack	•	•	•
Telematics, 6 -Year Subscription	•	•	•
Toolbox, lockable	•	•	•
Engine			
Exhaust after-treatment system	•	•	•
Three stage air cleaner, pre-cleaner, primary and secondary filter	•	•	•
Indicator glass for coolant level	•	•	•
Preheating of induction air	•	•	•
Fuel pre-filter with water trap	•	•	•
Fuel filter	•	•	•
Crank case breather oil trap	•	•	•
Exhaust heat ventilation	•	•	•
Electrical system			
24 V, pre-wired for optional accessories	•	•	•
Alternator 80A/3 135W	•	•	•
Battery disconnect switch	•	•	•
Maintenance free batteries	•	•	•
Battery box, steel	•	•	•
Fuel gauge	•	•	•
Hour meter	•	•	•
Electric horn	•	•	•
Instrument cluster:			
Fuel level	•	•	•
Diesel Exhaust Fluid/AdBlue level	•	•	•
Transmission temperature	•	•	•
Coolant temperature	•	•	•
Instrument lighting	•	•	•
Lighting:			
Twin halogen front headlights with high and low beams	•	•	•
Parking lights	•	•	•
Double brake and tail lights	•	•	•
Turn signals with flashing hazard light function	•	•	•
Halogen work lights (2 front and 2 rear)	•	•	•

	L60H	L70H	L90H
Contronic monitoring system			
Monitoring and logging of machine data	•	•	•
Contronic display	•	•	•
Fuel consumption	•	•	•
Diesel Exhaust Fluid/AdBlue consumption	•	•	•
Ambient temperature	•	•	•
Clock	•	•	•
Test function for warning and indicator lights	•	•	•
Brake test	•	•	•
Warning and indicator lights:			
Battery charging	•	•	•
Parking brake	•	•	•
Warning and display message:			
Regeneration	•	•	•
Engine coolant temperature	•	•	•
Charge air temperature	•	•	•
Engine oil temperature	•	•	•
Engine oil pressure	•	•	•
Transmission oil temperature	•	•	•
Transmission oil pressure	•	•	•
Hydraulic oil temperature	•	•	•
Brake pressure	•	•	•
Parking brake applied	•	•	•
Brake charging	•	•	•
Overspeed at direction change	•	•	•
Axle oil temperature	•	•	•
Steering pressure	•	•	•
Crank case pressure	•	•	•
Attachment lock open	•	•	•
Level warnings:			
Fuel level	•	•	•
Diesel Exhaust Fluid/AdBlue level	•	•	•
Engine coolant level	•	•	•
Transmission oil level	•	•	•
Hydraulic oil level	•	•	•
Washer fluid level	•	•	•
Engine torque reduction in case of malfunction indication:			
High engine coolant temperature	•	•	•
High engine oil temperature	•	•	•
Low engine oil pressure	•	•	•
High crank case pressure	•	•	•
High charge air temperature	•	•	•
Engine shutdown to idle in case of malfunction indication:			
High transmission oil temperature	•	•	•
Slip in transmission clutches	•	•	•
Key pad, background lit	•	•	•
Start interlock when gear is engaged	•	•	•

	L60H	L70H	L90H
Drivetrain			
Automatic Power Shift	•	•	•
Fully automatic gear shifting, 1-4	•	•	•
PWM-controlled gear shifting	•	•	•
Forward and reverse switch by hydraulic lever console	•	•	•
Indicator glass for transmission oil level	•	•	•
Differentials:			
Front: 100% hydraulic locking	•	•	•
Rear: Conventional	•	•	•
Tires			
17.5R25	•		
20.5R25	•	•	•
Brake system			
Dual brake circuits	•	•	•
Dual brake pedals	•	•	•
Secondary brake system	•	•	•
Parking brake, electrical-hydraulic	•	•	•
Brake wear indicators	•	•	•
Outboard mounted circulating oil cooled wet disc brakes on all four wheels	•	•	•
Cab			
ROPS (ISO 3471), FOPS (ISO 3449)	•	•	•
Single key kit door/start	•	•	•
Acoustic inner lining	•	•	•
Cigarette lighter, 24 V power outlet	•	•	•
Lockable door	•	•	•
Cab heating with fresh air inlet and defroster	•	•	•
Fresh air inlet with two filters	•	•	•
Automatic heat control	•	•	•
Floor mat	•	•	•
Dual interior lights	•	•	•
Interior rearview mirrors	•	•	•
Dual exterior rearview mirrors	•	•	•
Sliding window, right side	•	•	•
Tinted safety glass	•	•	•
Retractable seat belt (SAE J386)	•	•	•
Adjustable steering wheel	•	•	•
Storage compartment	•	•	•
Document pocket	•	•	•
Sun visor	•	•	•
Beverage holder	•	•	•
Windshield washer front and rear	•	•	•
Windshield wipers front and rear	•	•	•
Interval function for front and rear wipers	•	•	•
Foot step, left side (toolbox lockable included)	•	•	•

	L60H	L70H	L90H
Hydraulic system			
Main valve, double acting 2-spool with hydraulic pilots	•	•	•
Variable displacement axial piston pumps (2) for:			
Working hydraulics, pilot hydraulics, steering system, brakes	•	•	•
Cooling fan, brakes	•	•	•
Hydraulic control levers	•	•	•
Mechanical hydraulic lever lock	•	•	•
Automatic boom kick-out	•	•	•
automatic bucket positioner	•	•	•
Double acting hydraulic cylinders	•	•	•
Indicator glass for hydraulic oil level	•	•	•
Hydraulic oil cooler	•	•	•
External equipment			
Basic fenders, front and rear	•	•	•
Viscous cab mounts	•	•	•
Rubber engine and transmission mounts	•	•	•
Engine hood, electronically openable	•	•	•
Frame, joint lock	•	•	•
Vandalism lock for engine compartment	•	•	•
Lifting eyes	•	•	•
Tie down eyes	•	•	•
Tow hitch	•	•	•
Counterweight, pre drilled for optional guards	•	•	•

Equipment.

OPTIONAL EQUIPMENT

	L60H	L70H	L90H
Service and maintenance			
Automatic lubrication System	•	•	•
Automatic lubrication system for long boom	•	•	•
Oil sampling valve	•	•	•
Refill pump for automatic lubrication system	•	•	•
Grease nipple guards	•	•	•
Tool kit	•	•	•
Wheel nut wrench kit	•	•	•
Engine			
Air pre-cleaner, cyclone type	•	•	•
Air pre-cleaner, oil-bath type	•	•	•
Air pre-cleaner, turbo type	•	•	•
Engine auto shut down	•	•	•
Engine block heater, 120 V / 230 V	•	•	•
Fuel heater	•	•	•
Fuel fill strainer	•	•	•
Hand throttle control	•	•	•
Max. fan speed, hot climate	•	•	•
Reversible cooling fan	•	•	•
High altitude kit, 2 000 m / 6,560 ft up	•	•	•
Electrical			
Battery disconnect switch	•	•	•
Anti-theft device	•	•	•
Headlights, assym. left	•	•	•
Emergency stop	•	•	•
License plate holder, lighting	•	•	•
Reduced function working lights when reverse gear activated	•	•	•
Side marker lamps	•	•	•
License plate holder, lighting	•	•	•
Forward camera, color	•	•	•
Rear view camera incl. Monitor, color	•	•	•
Rear view mirrors, Long arm, right side	•	•	•
Rearview mirrors, adjustable, el. heated	•	•	•
Reverse alarm	•	•	•
Reverse lights	•	•	•
Reversing warning light	•	•	•
Reverse warning light, strobe lightning	•	•	•
Warning, collapsible, rotating beacon	•	•	•
Warning beacon, flashing strobe light	•	•	•
Working lights, attachments	•	•	•
Working lights front, high intensity discharge (HID)	•	•	•
Working lights front, on cab, dual	•	•	•
Working lights rear, on cab	•	•	•
Working lights rear, on cab, dual	•	•	•
Working lights front, extra	•	•	•
Working lights, front on cab, 2 LED lamps	•	•	•
Working lights, rear on cab, 2 LED lamps	•	•	•
Working lights, front on cab, 4 LED lamps	•	•	•
Working lights, rear on cab, 4 LED lamps	•	•	•
Working lights, side on cab, 4 LED lamps	•	•	•
Working lights, rear in grille, 2 LED lamps	•	•	•
Working lights, front above head lamps, 2 LED lamps	•	•	•
Taillight, LED lamp	•	•	•
Cab			
ACC control panel, with Fahrenheit scale	•	•	•
Anchorage for Operator's manual	•	•	•
Armrest, operator's seat, ISRI, left only	•	•	•
Armrest, operator's seat, Volvo, left	•	•	•
Asbestos dust protection filter	•	•	•
Automatic Climate Control, ACC	•	•	•
Automatic Climate Control, ACC, corr prot. Condenser	•	•	•
Cab air pre-cleaner, cyclone type	•	•	•
Carbon filter - cab	•	•	•
Foot steps, front frame	•	•	•
Remote door opener	•	•	•

	L60H	L70H	L90H
Cab			
Lunch box holder	•	•	•
Operator's seat, Volvo air susp, heavy-duty, high back, heated	•	•	•
Operator's seat, ISRI, air susp, heavy-duty, for CDC	•	•	•
Operator's seat, ISRI, heated, high back	•	•	•
Operator's seat, ISRI, low back	•	•	•
Seat belt (width 75 mm / 3")	•	•	•
Radio installation kit incl. 12 volt outlet, left-side	•	•	•
Radio installation kit incl. 12 volt outlet, right-side	•	•	•
Radio installation kit, 12 V, for USA	•	•	•
Radio with CD player	•	•	•
Forward view mirror	•	•	•
Rear view mirrors, el. adjusted and heated	•	•	•
Rear view mirrors, long arm right	•	•	•
Rear view mirrors, el. adjusted and heated, long arm right	•	•	•
Steering wheel knob	•	•	•
Sun blinds, rear windows	•	•	•
Sun blinds, side windows	•	•	•
Timer cab heating	•	•	•
Universal door/ignition key	•	•	•
Window, sliding, door	•	•	•
Drivetrain			
Rear axle with limited slip	•	•	•
Speed limiter, 20 km/h / 12 mph	•	•	•
Speed limiter, 30 km/h / 19 mph	•	•	•
Speed limiter, 40 km/h / 25 mph	•	•	•
Brake system			
Stainless steel, brake lines	•	•	•
Parking brake alarm, audible	•	•	•
Hydraulic system			
Arctic kit: Attachment locking, pilot hoses and hydraulic oil	•	•	•
Attachment bracket, cast, visibility-optimized	•	•	•
Attachment bracket, side-tilting	•	•	•
Separate attachment locking, long boom	•	•	•
Separate attachment locking, standard boom	•	•	•
Single acting lifting function	•	•	•
Boom suspension system	•	•	•
HD LS hydraulics, pump kit included	•	•	•
Hydraulic fluid, biodegradable, Volvo	•	•	•
Hydraulic fluid, fire resistant	•	•	•
Hydraulic fluid, for hot climate	•	•	•
Hydraulic function, 3rd	•	•	•
Detent for 3rd hydraulic function	•	•	•
Adjustable flow for 3rd hydraulic function	•	•	•
Hydraulic function, 3rd-4th	•	•	•
Single lever control	•	•	•
Single lever control for 3rd hydr. Function	•	•	•
External equipment			
Deleted front mudguards	•	•	•
Fire extinguisher	•	•	•
Bracket for fire extinguisher	•	•	•
Fire suppression system	•	•	•
Mudguards, full cover, rear for 80-series tires	•	•	•
Mudflap kit for mudguards, full cover for 80-series tires	•	•	•
Mudguards, full cover, rear and front/rear for 65-series tires	•	•	•
Mudflap kit for mudguards, full cover for 65-series tires	•	•	•
Footsteps front frame	•	•	•
Footsteps, right-hand side	•	•	•
Flexible rear step	•	•	•
Cab ladder, rubber suspended	•	•	•

	L60H	L70H	L90H
Protective equipment			
Anti-theft device	•	•	•
Belly guard front	•	•	•
Belly guard rear	•	•	•
Boom cylinder hose and tube guards	•	•	•
Cab roof, heavy duty	•	•	•
Center hinge and rear frame guard	•	•	•
Corrosion protection, painting	•	•	•
Cover plate front frame, heavy-duty	•	•	•
Cover plate, under cab	•	•	•
Cover plates rear frame	•	•	•
Guards for front head lights	•	•	•
Guards for grease nipples	•	•	•
Guards for radiator grill	•	•	•
Guards for tail lights, heavy-duty	•	•	•
Wheel/axle seal guards	•	•	•
Window guards, side and rear	•	•	•
Windshield guard	•	•	•
Other equipment			
CareTrack, GSM/Satellite	•	•	•
CE-marking	•	•	•
Secondary steering	•	•	•
Counterweight, logging	•	•	•
Noise reduction kit, Blauer Engel incl. Decal	•	•	•
Noise reduction kit, EU excl. Decal	•	•	•
Sign, 50 km/h / 31mph	•	•	•
Sign, slow moving vehicle	•	•	•

	L60H	L70H	L90H
Tires and Rims			
17.5R25	•		
20.5R25	•	•	•
600/65R25	•	•	•
650/65R25			•
Attachments			
Buckets:			
Straight	•	•	•
Spade nose	•	•	•
High tipping	•	•	•
Light material	•	•	•
Grading	•	•	•
Wear parts:			
Bolt-on edge	•	•	•
Bolt-on or weld-on bucket teeth	•	•	•
Segments	•	•	•
Log grapples	•	•	•
Fork equipment	•	•	•
Material handling arm	•	•	•
Snow blade	•	•	•
Broom	•	•	•
Sand spreading bucket	•	•	•
Bale clamp	•	•	•
Drum rotator	•	•	•

Selection of Volvo optional equipment

Boom suspension system



3rd and 4th hydraulic function



LED lights



Rear view camera



Reversible fan



Fire suppression system



Not all products are available in all markets. Under our policy of continuous improvement, we reserve the right to change specifications and design without prior notice. The illustrations do not necessarily show the standard version of the machine.



VOLVO

Volvo Construction Equipment
www.volvoce.com/na

Ref. No. VOE2210009367
Printed in USA, 2/2015
Volvo, Shippensburg
Copyright © 2015 Volvo

English-22
WLC