

Form No.  
917001/  
CP0905  
English

# **SL4640**

# **SL4840**

# **SL5640**

# **SL6640**

# **Skid-Steer**

# **Loaders**



# **Operator's Manual**

WRONG



Gehl Company, in cooperation with the American Society of Agricultural Engineers and the Society of Automotive Engineers, has adopted this Safety Alert Symbol to pinpoint precautions which, if not properly followed, can create a safety hazard. When you see this symbol in this manual or on the machine itself, you are reminded to **BE ALERT!** Your personal safety is involved!

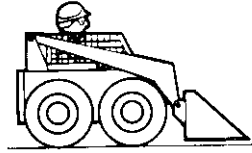

Never use loader without ROPS/FOPS. Never modify the ROPS/FOPS structure.



Operators must have instructions before running the machine. Untrained operators can cause injury or death.

CORRECT



Read Operator's Manual before using machine.

WRONG

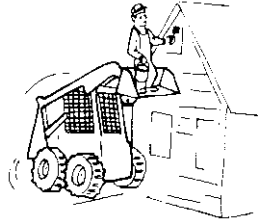

Never use the loader to lift personnel.

CORRECT

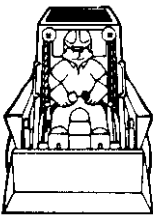

Always fasten seatbelt snugly. Always keep feet on the floor/pedals when operating loader.

WRONG

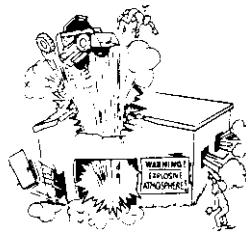

Do not use loader around explosive dust or gas, or where exhaust can contact flammable material.

# SL4640, SL4840, SL5640 and SL6640 Skid-Steer Loader

---

## TABLE OF CONTENTS

Introduction . . . . .	1
Safety . . . . .	5
Controls and Safety Equipment . . . . .	17
Operation . . . . .	37
Service . . . . .	47
Troubleshooting . . . . .	65
Maintenance . . . . .	75
Specifications . . . . .	79
Torque Specifications . . . . .	93
Warranty . . . . .	94
Index . . . . .	95

<b>Loader Model Number</b>	
<b>Loader Serial Number</b>	
<b>Engine Serial Number</b>	

All-Tach, Hydraloc and Hydraglide are trademarks of Gehl Company.  
Gehl and Powerview are registered trademarks of Gehl Company.

# Notes

---

# CHAPTER 1

## INTRODUCTION

This Operator's Manual provides the owner/operator with information for operating, maintaining and servicing SL4640, SL4840, SL5640 and SL6640 skid-steer loader models. More importantly, this manual provides an operating plan for safe and proper use of the machine. Major points of safe operation are detailed in the *Safety* chapter of this manual.

We ask that you read and understand the contents of this manual completely and become familiar with your new machine before operating it. See your authorized Gehl dealer if you have any questions concerning information in the manual, require extra manuals or for information concerning the availability of manuals in other languages.

Throughout this manual, information is provided set in *italic* type and introduced by the word **Note** or **Important**. Read carefully and comply with those messages – it will improve your operating and maintenance efficiency, help avoid breakdowns and damage, and extend your machine's life.

A manual storage box in the operator's compartment holds the Operator's Manual and AEM Safety Manual (also available in Spanish). Please return the manuals to this box and keep them with the unit at all times. If this machine is resold, we recommend that these manuals be given to the new owner.

The attachments and equipment available for use with this machine have a wide variety of potential applications. Read the manual provided with the attachment to learn how to safely maintain and operate the equipment. Be sure the machine is suitably equipped for the type of work to be performed.

Do not use this machine for any applications or purposes other than those described in this manual or those applicable for approved attachments. If the machine is to be used with special attachments or equipment other than those approved by Gehl Company, consult your Gehl dealer. Any person using non-approved attachments or making unauthorized modifications is responsible for the consequences.

The Gehl dealership network stands ready to provide you with any assistance you may require, including providing genuine Gehl service parts. All service parts should be obtained from your Gehl dealer. Provide complete information about the part and include the model and serial numbers of your machine. Record these numbers in the space provided on the Table of Contents page, as a handy reference.

Please be aware that Gehl strives to continuously improve its products and reserves the right to make changes and improvements in the design and construction of any part without incurring the obligation to install such changes on any previously delivered unit.

If this machine was purchased "used", or if the owner's address has changed, please provide your Gehl dealer or Gehl Company Service Department with the owner's name and current address, along with the machine model and serial num-

ber. This will allow the registered owner information to be updated, so that the owner can be notified directly in case of an important product issue.

# Loader Identification

---



- 1. Front Work Lights
- 2. Handholds
- 3. Tilt Cylinders
- 4. Hitch













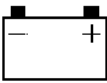













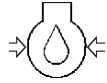





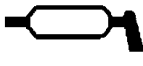









- 5. Restraint Bar
- 6. Lift Arm
- 7. Lift Cylinder
- 8. Tires



- 1. Engine Cover
- 2. Rear Work Lights
- 3. Tail Lights
- 4. Rear Door

- 5. Roll-Over/Falling Object Protective Structure (ROPS/FOPS)

# Control/Indicator Symbols

 Power Off	 Power On	 Engine Start	 Battery Charge	 Electrical Power
 Worklight w/Flasher	 Worklight	 Safety Alert	 Hazard Flasher	 Seatbelt
 Horn	 Read Operator's Manual	 Volume - Full	 Volume - Half Full	 Volume - Empty
<b>H-L</b> High - Low	<b>N</b> Neutral	<b>F</b> Forward	<b>R</b> Reverse	<b>(P)</b> Parking Brake
 Engine Air Filter	 Engine Oil	 Engine Oil Filter	 Engine Oil Pressure	 Fuel Filter
 Engine Temperature	 Hydraulic System	 Hydraulic Oil Temperature	 Hydraulic Oil Filter	 Grease Lubrication Point
 Glow Indicator Lamp	 Diesel Fuel	 Chaincase Oil	 Clockwise Rotation	 Counterclockwise Rotation
 Fast	 Slow	 Ride Control	 Power Hitch	 Bucket - Float
 Bucket - Rollback	 Bucket - Dump	 Lift Arm - Lower	 Lift Arm - Raise	 Service Hours
 Lift Point	 Tie-Down	 Diesel Water Separator	 Engine Malfunction Shutdown	



# CHAPTER 2

## SAFETY



This safety alert symbol means Attention! Become alert! Your safety is involved! It stresses an attitude of “Heads Up for Safety” and can be found throughout this Operator’s Manual and on the decals on the machine.

Before operating this machine, read and study the following safety information. For further reference on the safe operation of skid-steer loaders, Gehl Company suggests that equipment owners obtain the Gehl “Skid-Steer Loader Safety” video, which is available through Gehl dealers. In addition, be sure that everyone who operates or works with this machine, whether family member or employee, is familiar with these safety precautions. It is essential to have competent and careful operators, who are not physically or mentally impaired, and who are thoroughly trained in the safe operation of the machine and the handling of loads. It is recommended that the operator be capable of obtaining a valid motor vehicle operator’s license.

The use of skid-steer loaders is subject to certain hazards that cannot be eliminated by mechanical means, but only by exercising intelligence, care and common sense. Such hazards include, but are not limited to, hillside operation, overloading, instability of the load, poor maintenance and using the equipment for a purpose for which it is not intended or designed.

Gehl ALWAYS considers the operator’s safety when designing its machinery, and guards exposed moving parts for the operator’s protection. However, some areas cannot be guarded or shielded in order to assure proper operation. Furthermore, this Operator’s Manual and decals on the machine warn of additional hazards and they should be read and observed closely.

Some photographs in this manual may show doors, guards and shields open or removed for illustrative purposes only. Be sure that all doors, guards and shields are in their proper operating positions before starting the engine to operate the unit.

Different applications may require optional safety equipment, such as a back-up alarm, mirror, strobe light or an impact-resistant front door. Be sure you know the job site hazards and equip your machine as needed.



**DANGER**

“DANGER” indicates an imminently hazardous situation which, if not avoided, will result in death or serious injury.



**WARNING**

“WARNING” indicates a potentially hazardous situation which, if not avoided, could result in death or serious injury.



**CAUTION**

“CAUTION” indicates a potentially hazardous situation which, if not avoided may result in minor or moderate injury. May also alert against unsafe practices.

# Mandatory Safety Shutdown Procedure

---

Before cleaning, adjusting, lubricating or servicing the unit, or leaving it unattended:

1. Move the drive control handle(s) to the neutral position.
2. Lower the lift arm and attachment completely. If the lift arm *must* be left in the raised position, BE SURE to properly engage the lift arm support device (page 20).
3. Move the throttle to the low idle position, shut off the engine and remove the key.
4. Before exiting, move the lift/tilt control(s) to verify that the controls do not cause movement of the lift arm and hitch.

## Safety Reminders

---

### Before Starting

- Do not modify the ROPS/FOPS unless instructed to do so in installation instructions. Modifications such as welding, drilling or cutting can weaken the structure and reduce the protection it provides. A damaged ROPS/FOPS cannot be repaired – it must be replaced.
- To ensure safe operation, replace damaged or worn-out parts with genuine Gehl service parts.
- Gehl skid-steer loaders are designed and intended to be used only with Gehl attachments or approved referral attachments. Gehl cannot be responsible for operator safety if the loader is used with a non-approved attachment.
- Remove all trash and debris from the machine each day, especially in the engine compartment, to minimize the risk of fire.
- Always face the loader and use the handholds and steps when getting on and off the loader. Do not jump off the loader.
- Never use starting fluid (ether).
- Walk around the machine and warn all nearby personnel before starting the machine.
- Always perform a daily inspection of the machine before using it. Look for damage, loose or missing parts, leaks, etc.

## During Operation

- Machine stability is affected by: the load being carried, the height of the load, machine speed, abrupt control movements and driving over uneven terrain. **DISREGARDING ANY OF THESE FACTORS CAN CAUSE THE LOADER TO TIP, THROWING THE OPERATOR OUT OF THE SEAT OR LOADER, RESULTING IN DEATH OR SERIOUS INJURY.** Therefore: ALWAYS operate with the seatbelt fastened and the restraint bar lowered. Do not exceed the machine's Rated Operating Load. Carry the load low. Move the controls smoothly and gradually, and operate at speeds appropriate for the conditions.
- When operating on inclines or ramps, always travel with the heavier end of the loader toward the top of the incline for additional stability.
- Do not raise or drop a loaded bucket or fork suddenly. Abrupt movements under load can cause serious instability.
- Never push the lift control into the "float" position with the bucket or attachment loaded or raised, because this will cause the lift arm to lower rapidly.
- Do not drive too close to an excavation or ditch; be sure that the surrounding ground has adequate strength to support the weight of the loader and the load.
- Never carry riders. Do not allow others to ride on the machine or attachments, because they could fall or cause an accident.
- Always look to the rear before backing up the skid-steer loader.
- Operate the controls only from the operator's seat.
- Always keep hands and feet inside the operator's compartment while operating the machine.
- New operators must operate the loader in an open area away from bystanders. Practice with the controls until the loader can be operated safely and efficiently.
- Exhaust fumes can kill. Do not operate this machine in an enclosed area unless there is adequate ventilation.
- When you park the machine and before you leave the seat, check the restraint bar for proper operation. The restraint bar, when raised, deactivates the lift/tilt controls and auxiliary hydraulics, and applies the parking brake.

## Maintenance

- Never attempt to by-pass the keyswitch to start the engine. Use only the jump starting procedure detailed in the *Operation* chapter of this manual.
- Never use your hands to search for hydraulic fluid leaks. Instead, use a piece of paper or cardboard. Escaping fluid under pressure can be invisible and can penetrate the skin and cause serious injury. If any fluid is injected into your skin, see a doctor at once. Injected fluid must be surgically removed by a doctor or gangrene may result.

- Always wear safety glasses with side shields when striking metal against metal. In addition, it is recommended that a softer (chip-resistant) material be used to cushion the blow. Failure to heed could lead to serious injury to the eyes or other parts of the body.
- Do not smoke or have any spark-producing equipment in the area while filling the fuel tank or while working on the fuel or hydraulic systems.

## Potential Hazards

---

A skid-steer loader operator must ALWAYS be conscious of the working environment. Operator actions, the environmental conditions and the job at hand require the full attention of the operator so that safety precautions can be taken.

ALWAYS maintain a safe distance from electric power lines and avoid contact with any electrically charged conductor or gas line. Accidental contact or rupture can result in electrocution or an explosion. Contact the North American One-Call Referral System at: 1-888-258-0808 for the local “Digger’s Hotline” number or the proper local authorities for utility line locations BEFORE starting to dig!

Exposure to crystalline silica (found in sand, soil and rocks) has been associated with silicosis, a debilitating and often fatal lung disease. A Hazard Review (Pub. No. 2002-129) by the U.S. National Institute for Occupational Safety and Health (NIOSH) indicates a significant risk of chronic silicosis for workers exposed to inhaled crystalline silica over a working lifetime. NIOSH recommends an exposure limit of 0.05 mg/m<sup>3</sup> as a time-weighted average for up to a 10-hr workday during a 40-hr workweek. NIOSH also recommends substituting less hazardous materials when feasible, using respiratory protection and regular medical examinations for exposed workers.

## Safety Decals

---

The skid-steer loader has decals that provide safety information and precautions around the loader. These decals must be kept legible. If missing or illegible, they must be replaced promptly. Replacements can be obtained from your Gehl dealer. New equipment must have all decals specified by the manufacturer affixed in their proper locations.

## New Decal Application

Surfaces must be free of dirt, dust, grease and foreign material before applying the decal. Remove the smaller portion of the decal backing paper and apply the exposed adhesive to the clean surface, maintaining proper position and alignment. Peel the rest of the backing paper and apply hand pressure to smooth out the decal surface. Refer to the following pages for proper decal location. Text decals begin on page 9; no-text decals begin on page 13.

# ANSI-Style Safety Decals inside the ROPS/FOPS



**137628 – Located on manual box, behind seat**

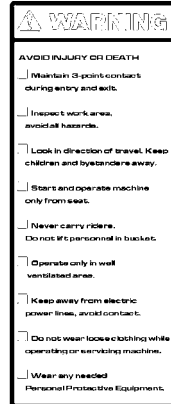
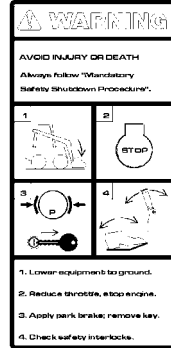
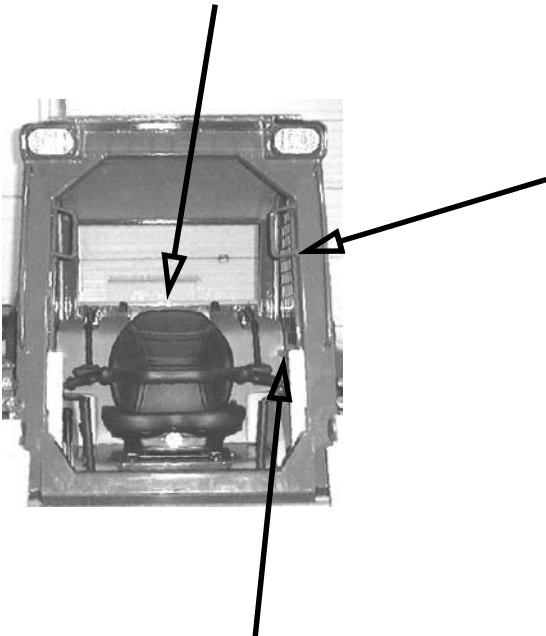

**Left Instrument Panel**



**137647 – Located on operator's lower left side**

# ANSI-Style Safety Decals on the outside of the Loader

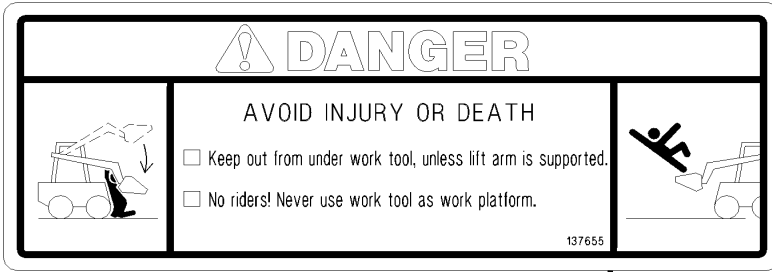

137655 – Located on front of loader



132166 – Located on rear window emergency exit

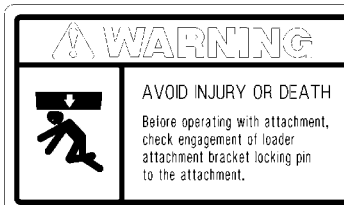

137720 – Located on hitch (manual hitch loaders only)

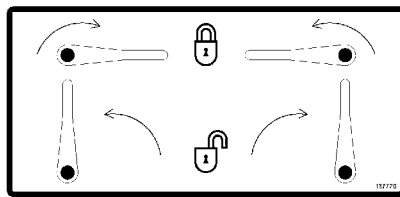

184481 – Located on hitch (power hitch loaders only)

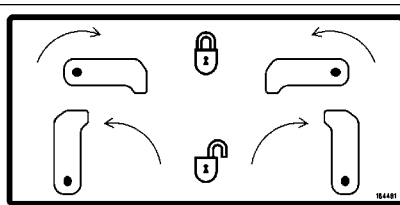

# ANSI-Style Safety Decals on the outside of the Loader



137647 – Located on the left fender and left side of ROPS/FOPS

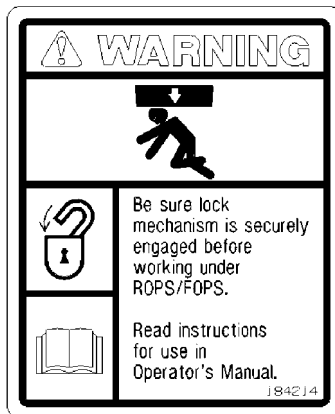





184214 – Located under the ROPS/FOPS

# ANSI-Style Safety Decals in the Engine Compartment

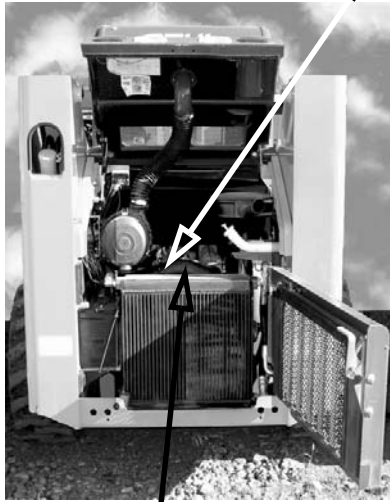
 <b>WARNING</b>	
<b>AVOID INJURY OR DEATH</b>	
<input type="checkbox"/> Keep safety devices working.	<input type="checkbox"/> Keep guards, screens and windows in place.
<input type="checkbox"/> Jump start per Operator's Manual procedure.	<input type="checkbox"/> Do not smoke while fueling or servicing machine.
<input type="checkbox"/> Clean debris from engine compartment daily to avoid fire. Keep fire extinguisher nearby.	
<input type="checkbox"/> Do not use hands to find hydraulic leaks. Escaping oil under pressure can be invisible and penetrate skin.	
<input type="checkbox"/> Allow radiator to cool before removing cap. Loosen cap slowly to avoid burns.	
<small>137657</small>	

137657 – Located on radiator



 <b>WARNING</b>			
	<b>ROTATING FAN</b>	<b>HOT SURFACE</b>	
	Keep hands out or stop engine.	Do not touch hot engine or hydraulic system parts.	
<small>137658</small>			

137658 – Located on radiator



# ISO-Style (used Internationally) Safety Decals inside the ROPS/FOPS



**137842 – Located on manual storage box, behind seat**

Safety alert: Read Operator's Manual and all safety signs before using machine. The owner is responsible to ensure all users are instructed on safe use and maintenance.

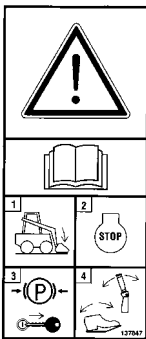

**137847 – Part of left instrument panel**

Safety alert: Always follow "Mandatory Safety Shutdown Procedure" in Operator's Manual.



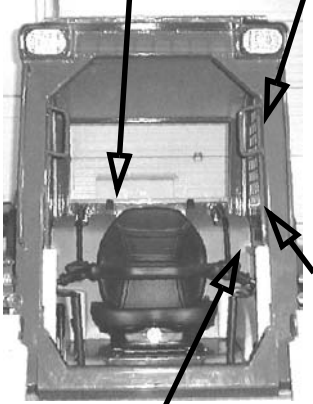
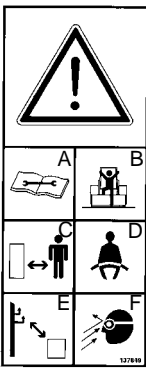





- 1 – Lower equipment to ground.
- 2 – Reduce throttle, stop engine.
- 3 – Apply parking brake; remove key.
- 4 – Check safety interlocks.

**137847 – Part of left instrument panel**

Safety alert:



- A** – Check machine before operating; Service per Operator's Manual. Contact dealer (or manufacturer) for information and service parts.
- B** – Maintain 3-point contact during entry and exit.
- C** – Inspect work area. Avoid all hazards. Look in direction of travel. Keep children and bystanders away.
- D** – Start and operate machine only from seat.
- E** – Keep away from power lines; avoid contact.
- F** – Wear any needed Personal Protective Equipment. Do not wear loose clothing while operating or servicing machine.

A	B	C	D
			
			

**137843 – Located on operator's lower left side**

- A** – Crush hazard: Keep out from under lift arm unless lift arm is supported.
- B** – Crush hazard: Keep hands, feet and body inside cab when operating.
- C** – Forward tip hazard: Fasten seat belt. Carry load low. Do not exceed Rated Operating Load.
- D** – Side tip hazard: Avoid steep slopes and high speed turns. Travel up and down slopes with heavy end uphill.

# ISO-Style (used Internationally) Safety Decals on the outside of the Loader

<p><b>A</b></p> 	<p><b>B</b></p> 
---	---



**137844 – Located on front of loader**

**A – Crush hazard:** Keep out from under work tool unless lift arm is supported.  
**B – Fall hazard:** No riders. Never use work tool as work platform.



**132166 – Located on rear window emergency exit**



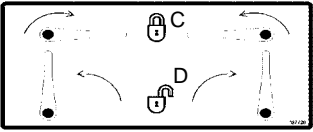

	<p><b>A</b></p>  <p><b>B</b></p> 	
---	--	---

**37852 – Located on hitch (manual hitch loaders only)**

**Crush hazard:** Before operating with attachment, check engagement of hitch locking pin to the attachment:

**A – Incorrect attachment engagement**      **C – Lock hitch lever**  
**B – Correct attachment engagement**        **D – Unlock hitch lever**

	<p><b>A</b></p>  <p><b>B</b></p> 
---	--

**139101 – Located on hitch (power hitch loaders only)**



**Crush hazard:** Before operating with attachment, check engagement of loader attachment bracket locking pin to the attachment:

**A – Incorrect attachment engagement**  
**B – Correct attachment engagement**

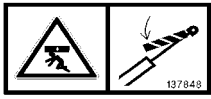
# ISO-Style (used Internationally) Safety Decals on the outside of the Loader

 <p>137848</p>	<p>Crush hazard: Hose removal or component failure can cause lift arm to drop. Always use lift arm support device when leaving lift arm raised for service.</p>
<p><b>137848 – Located on the left fender and left side of ROPS/FOPS</b></p>	



	
	
<p><b>184711 – Located under the ROPS/FOPS</b></p>	
<p>Crush hazard: Be sure lock mechanism is securely engaged before working under ROPS/FOPS. Read instructions for use in Operator's Manual.</p>	

# ISO-Style (used Internationally) Safety Decals in the Engine Compartment

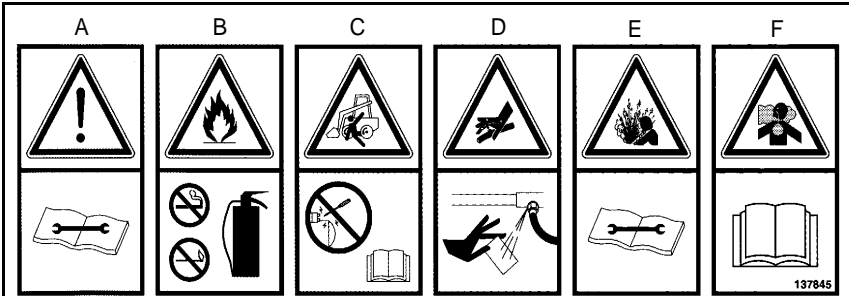

## 137845 – Located on radiator

**A** – Safety alert: Keep safety devices in place and in working order. Keep guards, screens and windows in place.

**B** – Fire hazard: Do not smoke while fueling or servicing machine. Clean debris from engine compartment daily to avoid fire. Keep fire extinguisher nearby.

**C** – Run-over hazard: Jump-start per Operator's Manual procedure.

**D** – Oil injection hazard: Do not use hands to find hydraulic leaks. Escaping oil under pressure can be invisible and penetrate skin. Use a piece of cardboard to find leaks.

**E** – Burn hazard: Allow radiator to cool before removing cap. Loosen cap slowly to avoid burns.

**F** – Suffocation hazard: Operate only in a well-ventilated area.

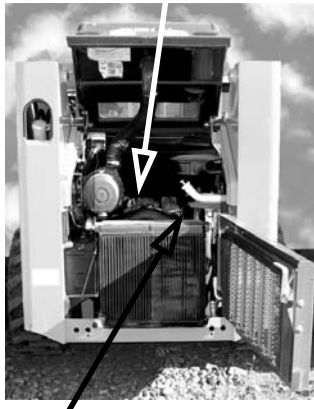

## 137845 – Located on radiator

**A** – Rotating fan: Keep hands out or stop engine.

**B** – Hot surface: Do not touch hot engine or hydraulic system parts.

# CHAPTER 3

## CONTROLS AND SAFETY EQUIPMENT

 **WARNING** Become familiar with and know how to use all safety devices and controls on the skid-steer loader before operating it. Know how to stop loader operation before starting it. This Gehl loader is designed and intended to be used only with a Gehl attachment or a Gehl-approved referral attachment or accessory. Gehl cannot be responsible for operator safety if the loader is used with a non-approved attachment.

### Guards and Shields

---

Whenever possible and without affecting loader operation, guards and shields are provided to protect against potentially hazardous areas. In many places, safety decals are also provided to warn of potential hazards and/or to display special operating procedures.

 **WARNING** Read and thoroughly understand all safety decals on the loader before operating it. Do not operate the loader unless all factory-installed guards and shields are properly secured in place.

### Operator Restraint Bar

---

Lower the restraint bar after entering the operator's compartment. The restraint bar is securely anchored to the ROPS. The restraint bar switch and the seat switch form an interlock for the lift arm, tilt, drive and starter circuits (refer to the *Safety Interlock System* topic on page 18 for more information).

 **WARNING** Never defeat the operator restraint bar or seat switch electrically or mechanically. Always wear the seatbelt.

## Operator's Seat

---

The seat is mounted on rails for rearward or forward repositioning. A spring-loaded latch handle activates the seat position adjustment mechanism.

Suspension seat (optional on all models): A weight adjustment knob is provided for individual operator adjustment.

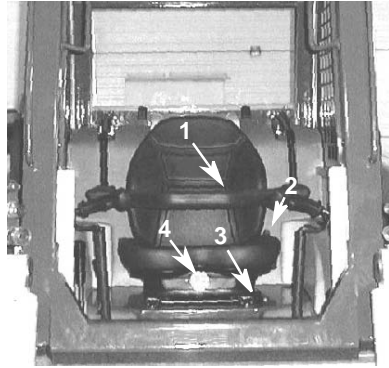

**Figure 1 Operator's Seat**

1. Restraint Bar
2. Seatbelt
3. Seat Position Adjustment Lever
4. Suspension Seat Weight Adjustment Knob (optional)

## Upper-Torso Restraint

---

**⚠ WARNING** Always wear the upper-torso restraint when operating in high speed.

The seatbelt should always be fastened during operation.

**Important:** *Inspect the seatbelt(s) for damage before use, and replace if damaged. Keep seatbelt(s) clean. Use only soap and water to wash seatbelt(s). Cleaning solvents can cause damage to seatbelt(s).*

## Safety Interlock System

---

### Hydraloc™

**⚠ WARNING** NEVER defeat the safety interlock system by mechanically or electrically bypassing any switches, relays or solenoid valves.

An interlock system is provided on the loader for operator safety. Together with solenoid valves, switches and relays, the interlock system:

- Prevents the engine from starting unless the operator is sitting on the seat and the operator restraint bar is lowered.

- Disables the lift arm, auxiliary hydraulics, attachment tilt and wheel drives whenever the operator leaves the seat, turns the keyswitch to Off or raises the restraint bar.

## Testing the Safety Interlock System

Before exiting the machine, check the safety interlock system for proper operation:

### Restraint Bar

With the engine running, raise the restraint bar. Test each of the controls. There should be no more than a slight movement of the lift arm, hitch and machine. If there is any significant movement, troubleshoot and correct the problem immediately. Contact your dealer if necessary.

### Seat Switch

With the engine off and the restraint bar lowered, unfasten the seatbelt, and lift your weight off the seat. Try to start the engine. If the engine starts, turn off the engine, troubleshoot and correct the problem. Contact your dealer if necessary.

## ROPS/FOPS

---

The ROPS/FOPS (Roll-Over/Falling Object Protective Structure) is designed to provide protection for the operator from falling objects and in case the loader tips or rolls over, provided the operator is secured inside the ROPS by the seatbelt and restraint bar.

 **WARNING** Never operate the loader with the ROPS/FOPS removed or locked back.

## Parking Brake

---

This skid-steer loader is equipped with a spring-applied, hydraulic-released parking brake. The parking brake engages when the operator lifts the restraint bar, exits the seat or shuts off the engine. The brake can also be applied manually by using the switch located on the left control panel of the ROPS/FOPS. A red indicator lights on the left control panel when the parking brake is applied.



**Figure 2** Parking Brake Switch

## Horn

---

Pressing the button on the lower right portion of the control handle sounds the horn (optional on all models).

# Rear Window Emergency Exit

---

The ROPS/FOPS rear window has three functions: noise reduction, flying objects barrier and emergency exit.

To use the emergency exit, pull on the yellow warning tag at the top of the window and remove the seal. Push or kick out the window and exit.

See your local automotive glass specialist to reinstall the window.

# Lift Arm Support Device

---

The lift arm support device is used as a cylinder lock to prevent the raised lift arm from lowering unexpectedly. Be sure to engage the support device when the lift arm is raised for service. When the support device is not being used, return it to its storage position. The support device is a safety device that must be kept in proper operating condition at all times. The following steps ensure correct usage:

**⚠ WARNING** The safest method of engaging the lift arm support device requires two people – one person inside the loader and another person outside the loader to engage the support device.

***Important:** With the keyswitch OFF and the solenoid valve functioning properly, the lift arm should stay raised if the lift control is moved to “lower”. If the solenoid valve does not hold the lift arm raised, lower the lift arm completely and contact your Gehl dealer immediately to determine why the cause.*

## Engagement

To engage the lift arm support device:

1. Lower the lift arm fully.
2. Stop the engine.
3. Leave the operator’s compartment. Press in and hold the lock pin button to release its locking mechanism. Remove the lock pin holding the support device up against the lift arm. Allow the support device to come down into contact with the lift cylinder.
4. Return to operator’s compartment and restart the engine.
5. Use the lift control to raise the lift arm until the support device drops over the end of the lift cylinder and around the cylinder rod. Slowly lower the lift arm until the free-end of the support device contacts the top end of the lift cylinder.
6. Look to make sure the support device is secure against the cylinder end. Then, stop the loader engine, remove the key and leave the operator’s compartment.

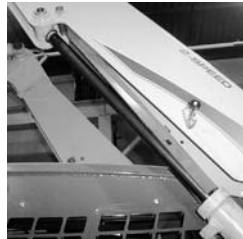

**Figure 3 Lift Arm Support Device Engaged**



## Disengagement

To return the lift arm support device to its storage position:

1. Start the engine;
2. Raise the lift arm fully;
3. Stop the engine;
4. Before leaving the operator's compartment, check to make sure that the lift arm is being held in the raised position by the solenoid valve (See Note below).

***Note:** With the keyswitch OFF and the solenoid valve working, the arm will stay raised when the lift control is moved forward. If the valve does NOT hold the lift arm and it begins to lower, do NOT leave the operator's compartment. Instead, have someone store the support device for you. Then, contact your Gehl dealer to determine the reason why the lift arm lowers while the keyswitch is in the OFF position.*



**Figure 4 Lift Arm Support Device Storage Location**

5. To store the support device, raise it up until it contacts the lift arm. Press in and hold the lock pin button to release its locking mechanism. Insert the lock pin through the hole in left arm and through the support device.

## Accessory Plug

---

The accessory plug is located at the bottom of the left instrument panel.

## Dome Light

---

The dome light is located on the right side of the ROPS head liner. Push the dome light to turn on the light.

## Work Lights

---

Loaders have two sets of work lights. The front work lights are located at the top of the ROPS/FOPS. The rear work lights are located at the rear of the engine cover.

## Heater (optional)

---

Loaders with the optional heater have a dial on the left instrument panel to control the fan speed.

## Heater and Air Conditioner (optional)

---

Loaders with the combination heater/ air conditioner have two controls on the left instrument panel: fan speed, air conditioner on/off, and temperature.

1. **Fan Speed:** Controls the rate at which air exits the vents.
2. **Heater/Air Conditioner Selector Switch:** Turns on either the heater or air conditioner. Center off position allows fan only operation for air circulation.

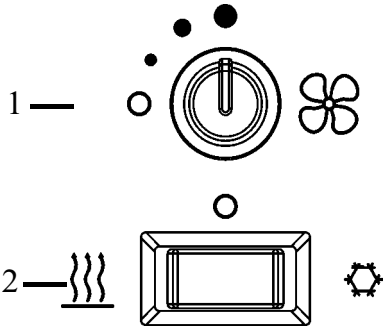

**Figure 5 Heater/  
Air Conditioner Controls**

*Note: The operator will feel cooler with only the two front vents opened and aimed at the upper body.*

## Engine Speed Control

---

A hand throttle lever (Figure 6) is provided for adjusting the engine speed. Move the control forward to increase and rearward to decrease the engine speed.



**Figure 6 Hand Throttle Lever**

**T-Bar, Dual Hand and T-bar/Joystick Controls Only:** A right-foot operated throttle pedal is provided to control the engine speed (Figure 7). The pedal linkage is spring-loaded to return to the pre-set hand throttle setting.



**Figure 7 Foot Throttle (T-Bar, Dual-Hand & T-bar/Joystick control units)**

## Two-Speed Transmission (optional)

---

Loaders with the optional two-speed transmission have a button on the left control handle for shifting between High (H) and Low (L). Shifting to High allows the machine to exceed 8 mph (13 km/h), up to a maximum speed of 12.4 mph (20 km/h).

## Hydraglide™ Ride Control System (optional)

---

Loaders with the optional ride control feature have a button on the right control handle for shifting between normal mode and ride control mode. The ride control system provides a smoother ride over uneven surfaces. Press the button once to activate the system and again to deactivate. The ride control system is automatically deactivated when the machine is shut off.

**⚠ WARNING** When hydraglide is activated, the lift arm may drop slightly without a load or several inches with a heavy load.

## Auto-Shutdown System

---

The auto-shutdown system will activate if the loader has an over-temperature situation or no oil pressure for more than 30 seconds. An audible alarm will sound and the Engine Coolant Temperature light or Engine Oil Pressure light will turn on and the loader will shut down after approximately 30 seconds.

## Attachment Mounting

---

The skid-steer loader is equipped with either the standard *manual* All-Tach hitch or the optional Power-A-Tach hitch for mounting a bucket and other attachments.

### All-Tach™ Hitch

With the standard hitch mechanism, two latch levers secure the attachment. Rotate the levers until the handles are horizontal to engage the lock pins. Rotate the levers until the handles are vertical to disengage the lock pins. (Refer to page 40 for more information.)



Figure 8 All-Tach™ Hitch

**⚠ WARNING** To prevent unexpected release of the attachment from the hitch, be sure to secure the latch pins by rotating the levers all the way to the stops.

## Power-A-Tach™ Hitch

With the optional hitch mechanism, a switch on the left control panel activates the latch pins. Metal “flags” on the pins indicate their position: the pin flags rotate to a horizontal position when engaging the pins and a vertical position when disengaging the pins. (Refer to page 40 for more information.)



**Figure 9 Power-A-Tach™ Hitch**



### **WARNING**

**To prevent unexpected release of the attachment from the hitch, be sure the latch pins are secure by verifying that the pin flags have moved fully to the outside of the hitch.**

# Instrument Panels

The instrument panels contain the switches and indicator lights. Symbols on the indicator lights are visible only when the indicator light are on.

## Left Panel

1. **Two-Speed Transmission (optional)** – Lights when high speed is engaged.
2. **Parking Brake** – Lights when the parking brake is applied.
3. **Power-A-Tach™ Hitch (optional)** – Used to operate the Power-A-Tach hitch.
4. **Fan (optional)** – Used to control the fan for the air conditioner and heater.
5. **Heater/Air Conditioner Selector** – Used to manually control the heater and air conditioner.
6. **Auxiliary Hydraulic Switch (Detent) (Hand/Foot Models only)** – A three-position detented switch use for continuous operation.
7. **Accessory Plug** – 12-volt DC power outlet.
8. **Hydraglide™ Ride Control System (optional)** – Lights when the ride control system is activated.
9. **Float Indicator (T-bar/Joystick control option only)** – Lights when float function is activated.
10. **Parking Brake Switch** – Used to manually apply the parking brake.

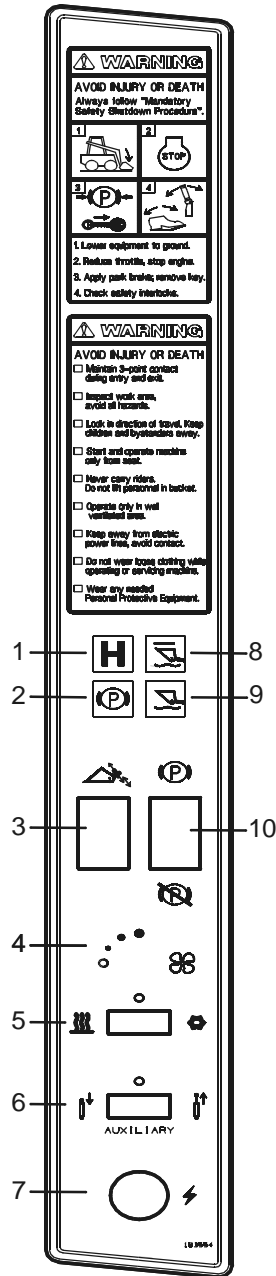

Figure 10 Left Panel

## Right Panel

1. **Hourmeter** – Displays the total operating hours of the loader.
2. **Fuel Level Gauge** – Displays the amount of fuel in the tank.
3. **Engine Oil Temperature Gauge** – Displays the temperature of the engine oil.
4. **Engine Oil Temperature** – Lights if the engine oil is too hot this warns the operator to stop the engine and determine and correct the cause for the high temperature. During normal operation this indicator should be OFF.
5. **Hydraulic Oil Temperature** – Lights if the hydraulic oil is too hot this warns the operator to reduce the hydraulic load and determine the cause of the high temperature. During normal operation this indicator should be OFF.
6. **Light Switch** – Controls all the lights on the loader. Symbols denote the four positions of the light switch. In a clockwise direction these are:
  - Off
  - Tail Lights
  - Front Work Lights with Tail Lights
  - both Front and Rear Work Lights
 For the lights to function, the keyswitch must be in the RUN position.
7. **Keyswitch** – In a clockwise rotation, these positions are:
  - **OFF Position** – With the key vertical, power from the battery is disconnected from the controls and instrument panel electrical circuits. This is the only position the key can be inserted or removed from the keyswitch.
  - **ON (or RUN) Position** – With the key turned one position clockwise from vertical, power from the battery is supplied to all control and instrument panel circuits.
  - **START Position** – With the key turned fully clockwise, the electric starter energizes, start the engine. Release the key to RUN position after the engine starts.

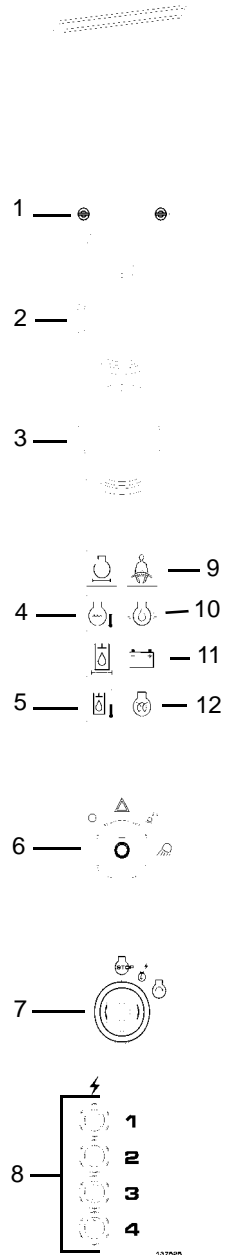

Figure 11 Right Panel

*Note: The engine cannot be started unless the operator is sitting in the seat and the restraint bar is lowered.*

8. **Circuit Breakers** – Four circuit breakers on the instrument panel protect the loader electrical circuits.

*Important: Do not attempt to defeat the circuit protection by jumping across or by installing a higher amperage circuit breaker.*

9. **Fasten Seatbelt** – A momentary visual (and audible) indicator to remind the operator to fasten the seatbelt(s).
10. **Engine Oil Pressure** – Lights if the engine oil pressure is too low. Warns the operator to immediately stop the engine and determine the cause for the low pressure. During normal operation this indicator should be OFF.
11. **Battery** – Lights if the charging voltage is too high or too low. During normal operation this indicator should be OFF.
12. **Preheat Indicator Lamp** – Lights when the preheat is active. During normal operation this indicator should be off.



## T-Bar Controls

Your loader may be equipped with the Gehl T-Bar control option. The left T-Bar controls the drive and the right T-Bar controls the lift/tilt.

### Drive Controls

Forward, reverse, speed and turning maneuvers are accomplished by movement of the left T-Bar. To go forward, push the control **forward**; for **reverse**, pull the control rearward. To turn **right**, turn the control clockwise; to turn **left**, turn the control counterclockwise. For gradual turns, move the T-Bar slightly forward or rearward. For sharp turns, turn the control clockwise or counterclockwise.

Moving the T-Bar farther from neutral increases the speed steadily to the maximum travel speed. Tractive effort decreases as speed increases. To get maximum tractive effort, move the T-Bar only slightly away from the neutral position. The engine will stall if the control is moved too far forward when loading the bucket.

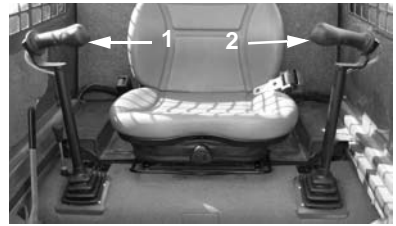

**Figure 12 T-Bar Controls**

1. Lift/Tilt Control
2. Drive Control

**⚠ WARNING** Be sure the T-Bar controls are in neutral before starting the engine. Operate the controls gradually and smoothly. Excessive speed and quick control movements without regard for conditions and circumstances are hazardous and could cause an accident.

### Lift/Tilt Control

Moving the lift arm and tilting the attachment are accomplished by movement of the right T-Bar. To **raise** the lift arm, pull the control straight rearward; to **lower** the lift arm, push the control straight forward. To **tilt the attachment forward and down**, twist the control clockwise; to **tilt the attachment up and back**, twist the control counterclockwise.

*Note: The speed of the lift/tilt motion is directly proportional to the amount of T-Bar movement and engine speed.*

To place the lift arm into the detent (“float”) position, push the right T-Bar all the way forward. This position allows the lowered lift arm to float while traveling over changing ground conditions.

**⚠ WARNING** Never push the lift/tilt T-Bar control into the “float” position with the attachment loaded or raised, because this will cause the lift arm to lower very rapidly.

# T-Bar/Joystick Controls

Your loader may be equipped with the Gehl T-Bar/Joystick control option. The left T-Bar controls the drive and the right joystick controls the lift/tilt.

## Drive Controls

Forward, reverse, speed and turning maneuvers are accomplished by movement of the left T-Bar. To go forward, push the control **forward**; for **reverse**, pull the control rearward. To turn **right**, turn the control clockwise; to turn **left**, turn the control counterclockwise. For gradual turns, move the T-Bar forward or rearward and turn slightly. For sharp turns, turn the control clockwise or counterclockwise.

Moving the T-Bar farther from neutral increases the speed steadily to the maximum travel speed. Tractive effort decreases as speed increases. To get maximum tractive effort, move the T-Bar only slightly away from the neutral position. The engine will stall if the control is moved too far forward when loading the bucket.

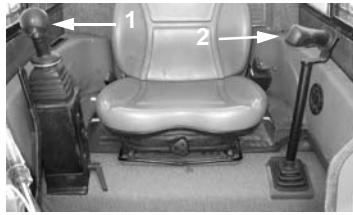

**Figure 13 T-Bar/Joystick Controls**

1. Lift/Tilt Control
2. Drive Control

**⚠ WARNING** Be sure the T-Bar controls are in neutral before starting the engine. Operate the controls gradually and smoothly. Excessive speed and quick control movements without regard for conditions and circumstances are hazardous and could cause an accident.

## Lift/Tilt Control

Moving the lift arm and tilting the attachment are accomplished by movement of the right joystick. To **raise** the lift arm, pull the control straight rearward; to **lower** the lift arm, push the control straight forward. To **tilt the attachment forward and down**, move the control to the right; to **tilt the attachment up and back**, move the control to the left.

*Note: The speed of the lift/tilt motion is directly proportional to the amount of joystick movement and engine speed.*

To place the lift arm into the detent (“float”) position, push and hold the left button on the right joystick. This mode allows the lowered lift arm to move up and down without moving the T-bar while traveling over changing ground conditions. An indicator light in the left instrument panel will blink when float is activated.

 **WARNING** Never push the float control button with the attachment loaded or raised, because this will cause the lift arm to lower very rapidly.

Releasing the float button will cancel the float mode if the button was pressed less than five seconds. If the float mode button is pressed longer than five seconds, the float feature will stay on and the float indicator lamp will light continuously until the button is pressed again.

# Hand/Foot Controls

Your loader may be equipped with the hand/foot control option. The handles control the drive and the foot pedals control the lift/tilt.

## Drive Controls

Forward, reverse, speed and turning maneuvers are accomplished by movement of the control handles. To go **forward**, push both handles forward; for **reverse**, pull both handles rearward. For **turning**, move one handle farther forward or rearward than the other handle. Turn direction is determined by which handle is moved farther forward; to turn left, move the right handle farther forward than the left handle; to turn right, move the left handle farther forward than the right handle. For sharp turns, move the handles in opposite directions.

Moving the handles farther from neutral increases the speed steadily to the maximum travel speed. Tractive effort decreases as speed increases. To get maximum tractive effort, move the handles only slightly away from the neutral positions. The engine will stall if the handles are moved too far forward when loading the bucket.

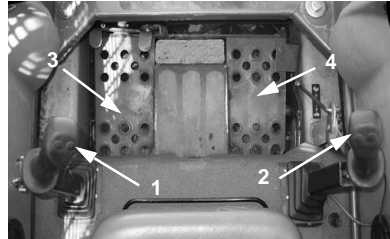

**Figure 14 Hand/Foot Controls**

- 1. Left Drive Control Handle
- 2. Right Drive Control Handle
- 3. Lift Control Pedal
- 4. Tilt Control Pedal

**⚠ WARNING** Be sure the controls are in neutral before starting the engine. Operate the controls gradually and smoothly. Excessive speed and quick control movements without regard for conditions and circumstances are hazardous and could cause an accident.

## Lift/Tilt Controls

Moving the lift arm and tilting the attachment are accomplished by movement of the foot pedals. The left pedal raises and lowers the lift arm; the right pedal tilts the attachment. To raise the lift arm, push down on the back of the left pedal with your left heel; to lower the lift arm, push down on the front of the left pedal with the toes of your left foot. To tilt the attachment forward and down, push down on the front of the right pedal with the toes on your right foot; to tilt the attachment up and back, push down on the back of the right pedal with your right heel.

*Note: The speed of the lift/tilt motion is directly proportional to the amount of pedal movement and engine speed.*

To place the lift arm into the detent (“float”) position, use the toes of your left foot to push the front of the left pedal all the way down. This position allows the lowered lift arm to float while traveling over changing ground conditions.



### **WARNING**

**Never push the left pedal into the “float” position with the attachment loaded or raised, because this will cause the lift arm to lower very rapidly.**

## Dual-Hand Controls

Your loader may be equipped with the dual-hand control option. The left handle controls the left side drive and the lift. The right handle controls the right side drive and the tilt.

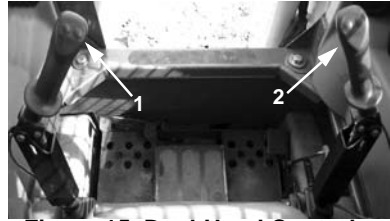

**Figure 15 Dual-Hand Controls**

1. Left Drive Control Handle
2. Right Drive Control Handle

### Drive Controls

Forward, reverse, speed and turning maneuvers are accomplished by pushing and pulling the handles. To go **forward**, push both handles forward; for **reverse**, pull both handles rearward. For **turning**, move one handle farther forward or rearward than the other handle. Turn direction is determined by which handle is moved farther forward; to turn left, move the right handle farther forward than the left handle; to turn right, move the left handle farther forward than the right handle. For sharp turns, move the handles in opposite directions.

Moving the handles farther from neutral increases the speed steadily to the maximum travel speed. Tractive effort decreases as speed increases. To get maximum tractive effort, move the handles only slightly away from the neutral position. The engine will stall if the handles are moved too far forward when loading the bucket.

**⚠ WARNING** Be sure the controls are in neutral before starting the engine. Operate the controls gradually and smoothly. Excessive speed and quick control movements without regard for conditions and circumstances are hazardous and could cause an accident.

### Lift/Tilt Controls

Moving the lift arm and tilting the attachment are accomplished by rotating the control handles. To **raise** the lift arm, rotate the left handle outward (to the left); to **lower** the lift arm, rotate the left handle inward (to the right). To **tilt the attachment forward and down**, rotate the right handle; to **tilt the attachment up and back**, rotate the right handle inward.

*Note: The speed of the lift/tilt motion is directly proportional to the amount of control movement and engine speed.*

To place the lift arm into the detent (“float”) position, push the left handle all the way inward. This position allows the lowered lift arm to float while traveling over changing ground conditions.

**⚠ WARNING** Never push the lift/tilt control into the “float” position with the attachment loaded or raised, because this will cause the lift arm to lower very rapidly.

# Auxiliary Hydraulic Controls

---

Auxiliary hydraulics are used with attachments that have a mechanism requiring its own hydraulic power.

**Important:** Always be sure the auxiliary hydraulic control is in neutral before starting the loader or disconnecting the auxiliary hydraulic couplers.

## Standard-Flow Auxiliary Hydraulic Control

Loaders are shipped from the factory with a standard-flow auxiliary hydraulic system with flat-face couplers. The couplers are located under the lift arm on the left hand side.

A second set of hydraulic couplers can be added to the front of the lift arm by ordering a field installation kit.

*T-Bar and Dual-Hand Control Loaders:* A foot pedal is used to control the direction of oil flow. A latch is provided to lock the foot pedal for continuous operation (Figure 16).

*Hand/Foot Control Loaders:* The right handle controls the direction of oil flow. A locking pin locks it in the up position for continuous operation (Figure 17).

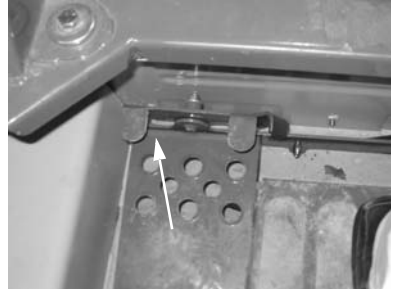

**Figure 16 T-Bar, Dual-Hand and T-bar/Joystick Auxiliary Hydraulic Control**



**Figure 17 Hand/Foot Auxiliary Control**

## High-Flow Auxiliary Hydraulic Control (optional)

In addition to a standard-flow auxiliary hydraulic system, some loaders are equipped with a reversible high-flow auxiliary hydraulic system. The couplers are located on the right lift arm. High-flow auxiliary hydraulics are used for operating certain hydraulic attachments (e.g., cold planer, snowblower) that require higher flows.



**Figure 18 High-Flow Control Lever (T-bar, Dual-Hand & Hand/Foot controlled units)**

A 3-position control lever, located behind the right control handle, is used to control the direction of oil flow. The lever is spring-centered, with a detent in the forward position for continuous operation.



**Figure 19 High Flow Control (T-bar/Joystick controlled units)**



# CHAPTER 4

## OPERATION

 **WARNING** Before starting the engine and operating the loader, review and comply with all safety recommendations in the Safety chapter of this manual. Know how to stop the loader before starting it. Also, be sure to fasten and properly adjust the seatbelt(s) and lower the operator restraint bar.

### Before Starting the Engine

---

Before starting the engine and running the loader, refer to the *Controls and Safety Equipment* chapter and familiarize yourself with the various operating controls, indicators and safety devices on the loader.

### Starting the Engine

---

The following procedure is recommended for starting the engine:

1. Carefully step up onto the back of the bucket or attachment and grasp the handholds to get into the operator's compartment.
2. Fasten the seatbelt(s) and lower the restraint bar.
3. Verify the following:
  - the lift/tilt, drive and auxiliary hydraulic controls are in their neutral positions,
  - the parking brake switch is on.
4. Push the throttle lever forward to approximately half speed.

*Note:* When the key is turned to the RUN position, an indicator will light on the instrument panel and a buzzer will sound momentarily to remind you to check that your seatbelt is fastened.

5. Turn the key to the start position.

*Note:* If temperature is below 32°F (0°C), see *Cold-Starting Procedure*, on page 38.

**Important:** Do not engage the starter for longer than 15 seconds at a time. Longer use can overheat and damage the starter. If the engine fails to start within 15 seconds, return the key to the off position. Allow the starter to cool for 20 seconds and repeat Step 5.

After the engine starts, allow a sufficient warm-up time before attempting to operate the controls.

**Important:** If the indicator warning lights do not go off, stop the engine and investigate the cause.

## Cold-Starting

---

If the temperature is below 32°F (0°C), try the following to make starting the engine easier:

- Replace the engine oil with SAE 10W30 oil;
- Make sure the battery is fully charged;
- Install an engine block heater.

An oil pan heater is recommended for starting in temperatures of 20°F (-7°C) or lower. See your dealer for heater options.

Let the engine run for a minimum of five minutes to warm the engine and hydraulic fluid before operating the loader.

## Cold-Starting Procedure

---

 **WARNING** Do not use starting fluid (ether) with preheat systems. An explosion can result, which can cause engine damage, injury or death.

1. Turn the key to the run position. If the preheat light on the right instrument panel comes on, wait until it goes out.
2. Turn the key switch to the start position.
3. Repeat if engine does not start.

## Stopping the Loader

---

The following procedure is the recommended sequence for stopping the loader:

1. Check that the drive control handle(s) is (are) in neutral position;
2. Lower the lift arm and rest the attachment on the ground;
3. Pull the throttle lever back to the low idle position (and/or take your foot off the throttle pedal for hands-only control machines);
4. Turn the keyswitch to the off position and remove the key; and
5. Raise the restraint bar, unfasten the seatbelt(s) and grasp the handholds while climbing out of the operator's compartment.

**Note:** *The skid-steer loader is equipped with a spring-applied automatic parking brake. The parking brake is applied when the operator lifts the restraint bar, leaves the operator's seat, shuts off the engine or actuates the parking brake switch.*

## Parking the Loader

---

Park the loader away from traffic on level ground. If this is not possible, park the loader across the incline and block the tires to prevent movement.

## Jump-starting

---

If the battery becomes discharged or does not have enough power to start the engine, use jumper cables and the following procedure to jump-start the loader engine.

** WARNING** The **ONLY** safe method for jump-starting a discharged battery is for **TWO PEOPLE** to perform the following procedure. The second person removes the jumper cables so that the operator does not have to leave the operator's compartment with the engine running. **NEVER** make jumper cable connections directly to the starter solenoid of either engine. **DO NOT** start the engine from any position other than on the operator's seat and then **ONLY** after being sure **ALL** controls are in "neutral".

**Closely follow the procedure, in order, to avoid personal injury. In addition, wear safety glasses to protect your eyes and avoid leaning over the batteries while jump-starting.**

DO NOT jump-start the battery if it is frozen, because it may rupture or explode.

*Note: BE SURE the jumper battery is a 12 volt D.C. battery.*

1. Turn the keyswitches of both vehicles to OFF, be sure the vehicles are in "neutral" and NOT touching each other.
2. Connect the positive (+) jumper cable to the positive (+) battery terminal on the disabled loader first. DO NOT allow the positive clamps to touch any metal other than the positive (+) battery terminals.
3. Connect the other end of the positive jumper cable to the jumper vehicle's battery positive (+) terminal.
4. Connect the negative (-) jumper cable to the jumper vehicle's battery negative (-) terminal.
5. Make the final negative (-) jumper cable connection to the disabled loader's engine block or loader frame (ground) – NOT to the disabled battery's negative post. If connected to the engine, keep the jumper clamp away from the battery, fuel lines and moving parts.
6. Start the loader. If it does not start at once, start the jumper vehicle engine to avoid excessive drain on the booster battery.
7. After the disabled loader is started and running smoothly, have the second person remove the jumper cables (negative (-) jumper cable first) from the jumper vehicle's battery and then from the disabled loader while being sure NOT to short the two cables together.

Allow sufficient time for the skid-steer loader alternator to build-up a charge in the battery before attempting to operate the loader or shut the engine off.

## Changing Attachments

**⚠ WARNING** To prevent unexpected release of the attachment from the hitch, be sure to properly secure the hitch latch pins by rotating the latch levers all the way (manual All-Tach™ hitch) or by ensuring that the pin flags are all the way to the outside (Power-A-Tach™ hitch).

The skid-steer loader features either a manual or a power hitch for mounting a bucket or other attachment conforming to SAE Standard J2513.

On a manual All-Tach hitch (Figure 20), two latch levers engage the latch pins to secure the attachment. On a Power-A-Tach hitch (Figure 21), a switch on the left control panel activates the latch pins to secure the attachment.

### Connecting Attachments

1. **Manual hitch:** Rotate the latch levers until the handles are horizontal to engage the lock pins.



**Figure 20 Manual Hitch – disengaged**

1. Latch Lever
2. Latch Pins

2. **Power hitch:** Activate the switch to unlock the hitch and fully retract the latch pins.

3. Start the loader engine. Be sure the lift arm is lowered and in contact with the loader frame.

4. Align the loader squarely with the back of the attachment.

5. Tilt the hitch forward until the top edge of the hitch is below the flange on the back side of the attachment and centered between the vertical plates.

6. Slowly drive the loader forward and, at the same time, tilt the hitch back to engage the flange on the back side of the attachment.

7. Stop forward travel when the flange is engaged, but continue to tilt the hitch back to lift the attachment off the ground.

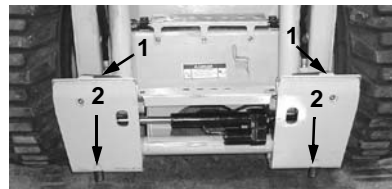

**Figure 21 Power Hitch – disengaged**

1. Pin Flags
2. Latch Pins

8. **Manual hitch:** Exercise the MANDATORY SAFETY SHUTDOWN PROCEDURE (page 6). Exit the operator's compartment and rotate the latch levers to the horizontal position to fully engage the latch pins.
9. **Power hitch:** Activate the switch to lock the hitch and fully engage the latch pins.

**Important:** To check that the attachment is properly installed, apply downward pressure to the attachment prior to operating.

## Connecting Auxiliary Hydraulic Couplings

**Note:** With the engine off, key in the on position and the restraint bar down, the auxiliary hydraulic control can be moved to relieve any pressure in the hydraulic system.

### Standard-Flow Auxiliary Hydraulics

Coupler hookup is located on the left lift arm. When the auxiliary control is in the detent position, the top coupler is "pressure", and the bottom coupler is "return".

### High-Flow Auxiliary Hydraulics

Coupler hookup is located on the right lift arm. When the auxiliary control is in the detent position, the top coupler is "pressure", and the middle coupler is "return". The smaller bottom coupler is for the case drain.

 **WARNING** Only connect high-flow attachment couplers to the high-flow auxiliary couplers.

## Removing Attachments

1. Tilt the hitch back until the attachment is off the ground.
2. Exercise the MANDATORY SAFETY SHUTDOWN PROCEDURE (page 6).
3. Relieve any hydraulic pressure in the auxiliary and attachment lines.
  - a. Turn the key on (do not start the engine).
  - b. With the restraint bar down, move the auxiliary hydraulic control back and forth. This will relieve the pressure in the hydraulic system.
4. With the engine off, leave the operator's compartment and disconnect the auxiliary hydraulic hoses.
5. **Manual hitch:** Rotate the hitch latch levers to the vertical position to fully retract the latch pins.

**Power hitch:** Turn the key ON (do not start the engine) and activate the switch to unlock the hitch and fully retract the latch pins.
6. Start the engine and be sure that the lift arm is fully lowered and in contact with the loader frame.
7. Tilt the hitch forward and slowly back the loader away until the attachment is free from the loader.

## Self-Leveling

---

The feature is intended to automatically keep the attachment level while the lift arm is being raised.

## Using a Bucket

---

**⚠ WARNING** Always maintain a safe distance from electric power lines and avoid contact with any electrically charged conductor or gas line. Accidental contact or rupture can result in electrocution or an explosion. Contact the “Digger’s Hotline” or proper local authorities for utility line locations before starting to dig.

### Driving over Rough Terrain

When traveling over rough terrain, drive slowly with the bucket lowered.

### Driving on an Incline

When traveling on an incline, travel with the heavy end pointing uphill.

### Digging with a Bucket

Approach the digging site with the lift arm slightly raised and the bucket tilted forward until the edge contacts the ground. Dig into the ground by driving forward and gradually lowering the lift arm (Figure 22).

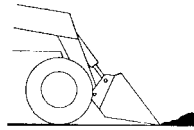

Figure 22 Digging

When the bucket is filled, tilt the bucket back, and back the loader away from the material. Rest the lift arm against the loader frame before proceeding to the dumping area.

**⚠ WARNING** Always carry the loaded bucket with the lift arm resting on the loader frame. For additional stability when operating on inclines, always travel with the heavier end of the loader toward the top of the incline.

## Loading a Bucket

Approach the pile with the lift arm fully lowered and the bucket tilted slightly forward until the edge contacts the ground. Drive forward, lifting the lift arm and tilting back the bucket to fill it. Back away from the pile (Figure 23).

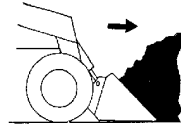

Figure 23 Loading

## Dumping the Load Onto a Pile

Carry a loaded bucket as low as possible until the pile is reached. Gradually stop forward motion and raise the lift arm high enough so that the bucket clears the top of the pile. Then, slowly move the loader ahead to position the bucket to dump the material on top of the pile. Dump the material and then back the loader away while tilting the bucket back and lowering the lift arm.

**⚠ WARNING** Never push the controls into “float” position with the bucket or attachment loaded or raised, because this will cause the lift arm to lowering rapidly.

## Dumping the Load Into a Box

Carry the loaded bucket low and approach the vehicle or bin. Stop your approach as close to the side of the box as possible while allowing for clearance to raise the lift arm and loaded bucket. Next, raise the lift arm until the bucket clears the top of the box and move the loader ahead to position the bucket over the inside of the box. Dump the material and then back away from the box while tilting the bucket back and lowering the lift arm (Figure 24).

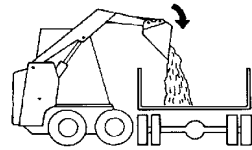

Figure 24 Dumping Into a Box

## Dumping the Load Over an Embankment

**⚠ WARNING** Do not drive too close to an excavation or ditch. Be sure the surrounding ground has adequate strength to support the weight of the loader and the load.

Carry the loaded bucket as low as possible while traveling to the dumping area. Stop the loader where the bucket extends half-way over the edge of the embankment. Tilt the bucket forward and raise the lift arm to dump the material. Dump the material and then back away from the embankment while tilting the bucket back and lowering the lift arm.

## Scraping with a Bucket

For scraping, the loader should be operated in the forward direction. Position the lift arm down against the loader frame. Tilt the bucket cutting edge forward at a slight angle to the surface being scraped. While traveling slowly forward with the bucket in this position, material can flow over the cutting edge and collect inside the bucket (Figure 25).

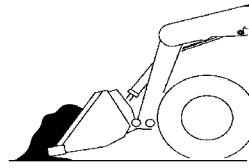

Figure 25 Scraping

## Leveling the Ground

Drive the loader to the far edge of the area to be leveled. Tilt the bucket forward to place the bucket cutting edge at a 30 to 45 degree angle to the surface being leveled. Then place the lift arm into the float position and drive the loader rearward, dragging the dirt and, at the same time, leveling it (Figure 26).

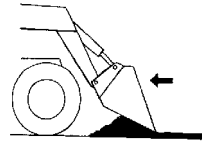

Figure 26 Leveling the Ground

**Note:** The “float” (detent) position for T-Bar loaders is reached by pushing the right handle all the way forward, and for dual-hand control loaders by rotating the left handle all the way outward. For hand/foot control loaders, use the toes of the left foot to push the front of the left pedal all the way down. For T-bar/Joystick control loaders press float button the right grip. Pressing button for more than 5 seconds will allow the machine to go into detent (“float”) mode. Press again to cancel detent.

**WARNING** Check that the work area is clear of people and obstacles. Always look in the direction of travel.

## Highway Travel

---

If it becomes necessary to move the loader a long distance, use a properly rated trailer. (See *Transporting the Loader* on page 45) For short distance highway travel, attach an SMV (Slow Moving Vehicle) emblem (purchased locally) to the back of the loader. For highway operation, install dual amber flashers or a strobe light. Check state and local laws and regulations.



## Storing the Loader

---

If your skid-steer loader is to be stored for a long period of time, the following procedure is suggested:

1. Fully inflate the tires.
2. Lubricate all grease zerks.
3. Check all fluid levels and replenish as necessary.
4. Add stabilizer to the fuel per the fuel supplier's recommendations.
5. Remove the battery, charge fully and store in a cool, dry location.
6. Protect against extreme weather conditions such as moisture, sunlight and temperature.

## Transporting the Loader

---

**⚠ WARNING** Park the truck or trailer on a level surface. Be sure the vehicle and its ramps have the weight capacity to support the loader. Be sure the vehicle surface and its ramps are clear of debris and slippery material that may reduce traction. Move the loader on and off the vehicle ramp slowly and carefully. Failure to follow these instructions could result in an overturn accident.

Observe all local regulations governing the loading and transporting of equipment (Reference U.S. Federal Motor Carrier Safety Regulations, Section 392.9). Ensure that the hauling vehicle meets all safety requirements before loading the skid-steer loader.

1. Place blocks at the front and rear of the hauling vehicle's tires.
2. If the loader has an attachment, lift it slightly off the ground.
3. Back the loader slowly and carefully up the ramp onto the vehicle.
4. Lower the loader attachment to the vehicle deck, turn off the engine and remove the key.
5. Fasten the loader to the hauling vehicle at the points indicated by the tie-down decals (Figure 27 and Figure 28).
6. Measure the clearance height of the loader and hauling vehicle. Post the clearance height in the cab of the vehicle.

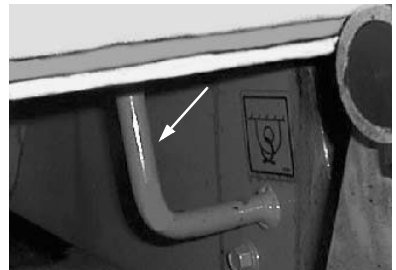

Figure 27 Front Tie-Down

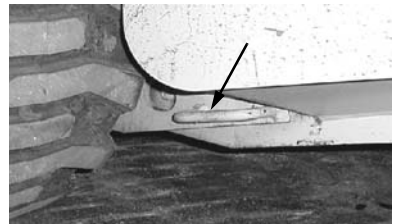

Figure 28 Rear Tie-Down

# Lifting the Loader

The loader can be lifted using a single-point or four-point lift kit, which is available from your Gehl dealer.

## **WARNING**

- **Before lifting, check the lift kit for proper installation.**
- **Never allow riders in the operator's compartment while the loader is lifted.**
- **Keep everyone a safe distance away from the loader while it is lifted.**
- **Loader may only be lifted with an empty bucket or empty pallet forks, or with no attachment. Never lift the loader with attachments other than those stated.**

Lift equipment used and its installation is the responsibility of the party conducting the lift. All rigging **MUST** comply with applicable regulations and guidelines.

1. Using suitable lift equipment, hook into the lift eyes. Adjust the length of the slings or chains to lift the loader level.

**Important:** *As needed, use a spreader bar to prevent the slings or chains from rubbing the sides of the ROPS/FOPS. (Four-point lift only)*

**Note:** *The loader may be slightly off level (10 degrees max.) when lifted, depending on loader model and attachment (single-point lift only.)*

2. Center the hoist over the ROPS/FOPS. To prevent shock loading of the equipment and excessive swinging, slowly lift the loader off the ground. Perform all movements slowly and gradually. As needed, use a tag line to help position the loader.

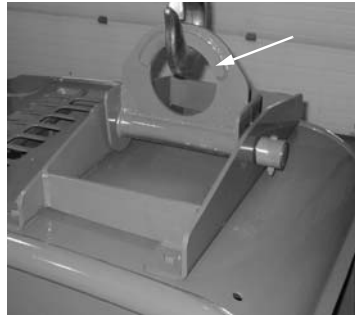

**Figure 29 Single-Point Lift Eye**

# CHAPTER 5

## SERVICE

 **WARNING** Before servicing the machine, unless expressly instructed to the contrary, exercise the MANDATORY SAFETY SHUTDOWN PROCEDURE (page 6).

After service has been performed, be sure to restore all guards, shields and covers to their original positions before resuming operation.

This Service chapter details procedures for performing routine maintenance checks, adjustments and replacements. Most procedures are referred to in the *Troubleshooting* and *Maintenance* chapters of this manual. Refer to the *Maintenance Interval Chart* (page 75) for service intervals. Refer to the separate engine manual for engine-related adjustments, lubrication and service procedures.

*Note:* All service procedures, except those described under the Dealer Services topic are owner-operator responsibilities.

*Important:* Always dispose of waste lubricating oils and hydraulic fluids according to local regulations or take to a recycling center for disposal. Do not pour onto the ground or down the drain.

### Dealer Services

---

The following areas of component service, replacement and adjustments require special tools and knowledge for proper servicing and should be performed only by your authorized Gehl skid-steer loader dealer: hydrostatic drive components, hydraulic system pumps, valves, hydraulic cylinders, electrical components (other than battery, circuit breakers).

## Replacement Parts

Part Description	Gehl Part No.
Air Cleaner Element, Primary	184146
Air Cleaner Element, Secondary	184195
Hydraulic Oil Filter Element	074830
Engine Oil Filter Element	132023
Fuel Filter Cartridge	132024
Fresh Air Intake Filter (heater option)	184708
Recirculation Air Filter (heater option)	184709

***Note:** Part numbers may change. Your Gehl dealer will always have the latest part numbers.*

***Important:** To ensure continued warranty coverage, only genuine Gehl replacement filters are to be used.*

## Loader Raising Procedure

To raise the skid-steer loader so all four (4) tires ARE NOT contacting the ground, use the procedure below:

**⚠ WARNING** Do not rely on a jack or hoist to maintain the raised position without additional blocking and supports. Serious personal injury could result from improperly raising or blocking the loader.

1. To block the loader, obtain enough solid wooden blocks, so that when stacked, all of the tires are raised off the ground.

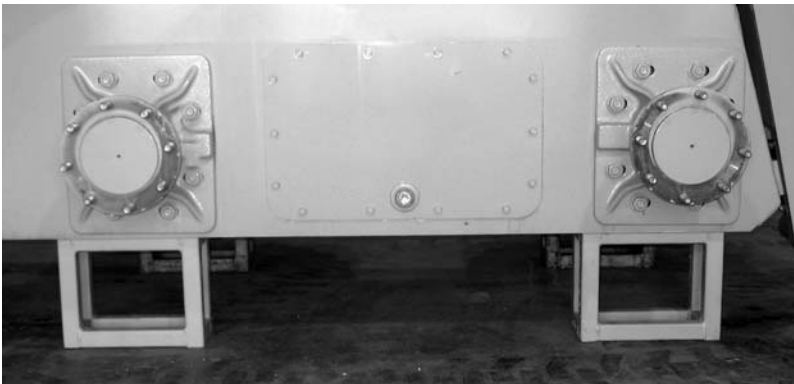

**Figure 30 Loader Properly Blocked  
(Tires and wheels removed to show blocks)**

2. Using a jack or hoist capable of lifting at the fully-equipped weight of the loader (with all attached options), lift the rear of the loader until the rear tires are off the ground.
3. Stack wooden blocks under the flat part of the loader chassis. They should run parallel with, but not touch, the rear tires.
4. Slowly lower the loader until its weight rests on the blocks. If the tires still touch the ground, raise the loader again, add more blocks and lower again.
5. Repeat Steps 2 through 4 for the front end. When the procedure is finished, all four tires are off the ground so they could be removed.

## Loader Lowering Procedure

---

When service or adjustment procedures are complete, the loader can be lowered from the raised position. To lower the loader onto its tires:

1. Using a jack or hoist, raise the front of the loader until its weight no longer rests on the front blocks.
2. Carefully remove the blocking under the front of the loader.
3. Slowly lower the loader until the front tires are resting on the ground.
4. Repeat Steps 1 through 3 for the rear of the loader. When the procedure is finished, all four tires will be on the ground and the blocks removed from under the loader.

## Engine Compartment Access

---

To open the engine compartment, lift the engine cover. Then pull the rear door latch and carefully swing open the rear door.



**Figure 31 Engine Compartment**

## Tilting Back the ROPS/FOPS

---

The ROPS/FOPS is designed to protect the operator from flying objects and provide protection if the loader tips or rolls over, provided the operator is secured inside the ROPS/FOPS by the seat belt and restraint bar.

For service, unbolt the ROPS/FOPS and tilt it back slowly, moving the control handles out of the way. Two gas-charged springs help tilt it back. A self-actuating lock mechanism will engage to lock when the ROPS/FOPS is in a rolled-back position. To lower the ROPS/FOPS apply upward force on it while pushing the lock mechanism handle toward the rear of the loader.

Lower the ROPS/FOPS slowly onto the chassis, moving the control handles out of the way. Reinstall the anchor bolts, washers and locknuts.

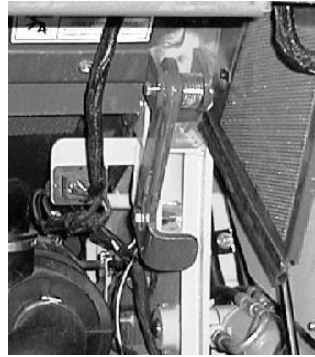

**Figure 32 ROPS/FOPS Lock Mechanism – Engaged**

**⚠ WARNING** Never operate the loader with the ROPS/FOPS removed or tilted back. Be sure the lock mechanism is securely engaged when the ROPS/FOPS is tilted back. Be sure to reinstall the anchor bolts, washers and locknuts before resuming operation.

## Adjustments

---

### Control Handles

The control handles do not require routine adjustment. Refer to the *Service Manual* for the initial setup procedure.

### Fuel Sender

The fuel gauge sender, located on the fuel tank, sends a signal to the fuel gauge to indicate the amount of fuel in the fuel tank.

Check the fuel gauge sender periodically to ensure that the mounting screws are tight and that there is no fuel around the gasket. If service is required, apply an RTV or gasket sealant around the gasket when restoring the sender.

## Engine Speed Control

The throttle does not require routine adjustment. Refer to the *Service Manual* for the initial setup procedure.

The throttle lever friction pad pressure can be adjusted if the throttle lever does not hold its position. Belleville washers and a lock nut on the throttle lever are used for making this adjustment.

## Foreign Material Removal

---

The loader should be cleared daily of dirt and other foreign materials in the following areas:

- around the lift cylinders
- at the front of the loader
- on the hitch, especially around tilt cylinder
- around the hydraulic oil reservoir breather
- in the engine compartment
- in the operator's compartment

**Important:** *Build up of foreign materials in these areas can interfere with the operation of the loader, cause component damage or become a fire hazard.*

## Lubrication





---

Listed below are the temperature ranges and types of lubricants for this machine. Refer to the separate engine manual for more information regarding engine lubricants, quantities and grades required.

**Note:** *Refer to the specific service sections for detailed information on periodic checking and replenishing of lubricants.*

Refer to Figure 33 for grease fitting locations. Wipe dirt from the fittings before greasing them to prevent contamination. Replace any missing or damaged fittings. To minimize dirt build-up, avoid excessive greasing.

**Important:** *Always dispose of waste lubricating oils and hydraulic fluids according to local regulations or take to a recycling center for disposal. Do not pour onto the ground or down the drain.*

System	Lubricant
 <b>Hydraulic System Oil</b>	Use Petro Canada HVI60, Mobil DTE 15M or equivalent which contains anti-rust, anti-foam and anti-oxidation additives, and conforms to ISO VG46. <b>Capacity:</b> 4640/4840: 12 U.S. gallons (45 L) 5640/6640: 16 U.S. gallons (61 L)
 <b>Chaincase Oil</b>	Use hydraulic system oil or SAE grade 15W40 motor oil. <b>Capacity</b> (each side): 8 U.S. quarts (7.5 L)
 <b>Grease Fittings</b>	Use lithium-based grease.
 <b>Engine Oil</b>	Below 32°F (0°C) – Use SAE Grade* 10W or 10W30 Above 32°F (0°C) – Use SAE Grade* 15W40 *Service Classification: API – CH4 <b>Capacity:</b> 3 cylinder: 8.3 U.S. quarts (7.9 L) 4 cylinder: 11.5 U.S. quarts (10.8 L)



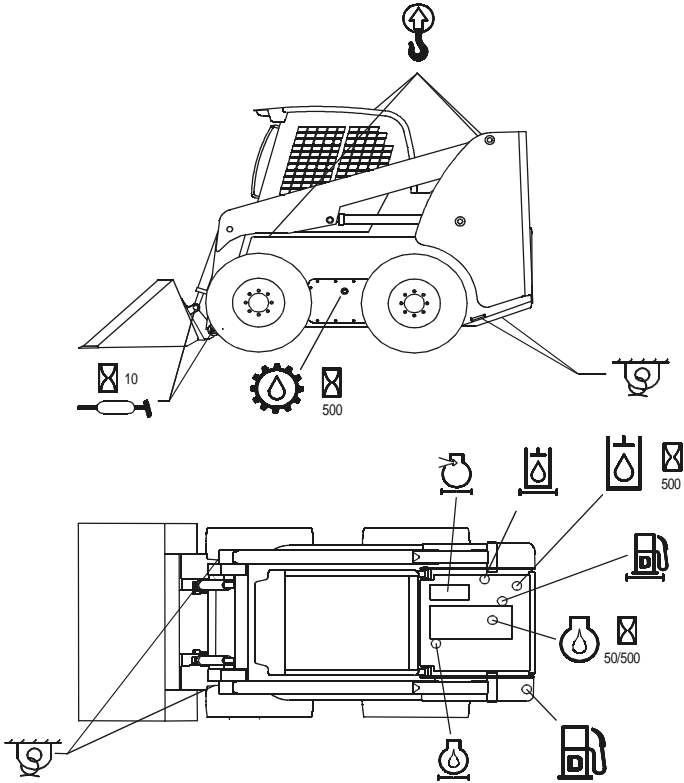

**Figure 33 Service Locations**

Lubrication Procedure	10 Hours (or Daily)	250 Hours	500 Hours (or Yearly)
Check Engine Oil Level (page 57)	l		
Check Hydraulic Oil Level (page 59)	l		
Grease Lift Arm, Hitch, Cylinder Pivots and Latch Pins	l		
Check Oil Level in Chaincases (page 54)	o	l	
Change Engine Oil and Filter (page 58)	o	v	l
Change Hydraulic Oil Filter (page 59)	o		l
Change Hydraulic Oil (page 60)			t
Change Chaincase Oil (page 54)	o		t
Check and Drain Water Separator	l		

- o Perform the initial procedure at 50 hours, then at “l” or “t” intervals.
- v Severe operating conditions.
- t Perform the procedure at 1000 hours.

## Chaincases

---

There is a chaincase on each side of the loader. Refer to the *Maintenance Interval Chart* (page 75) for change intervals. Refer to the *Lubrication* chart (page 53).

### Checking and Adding Oil

1. Park the loader on a level surface. Stop the engine.
2. Remove the fill and check plug (Figure 34) from each chaincase cover. The oil level should be at the plug level or no more than 1/4 in. (6 mm) below.
3. If the level is low, add fluid through the fill and check plug; (Figure 34) until the oil level reaches the check plug hole. Reinstall the plug.



**Figure 34 Fill and Check Plug Location**

### Draining Oil

1. Park the loader on a level surface, or on a sloping surface with the loader facing downhill and the tires blocked.
2. Remove the drain plug on each chaincase and drain the oil (Figure 35) into a suitable container.
3. Reinstall and tighten the drain plugs.
4. Refill the chaincases at the fill plugs.



**Figure 35 Drain Plug**

## Drive Chains

---

Drive chains are located in the chaincase on each side of the machine. Refer to the *Maintenance Interval Chart* (page 75) for tension check interval.

## Checking Chain Tension

1. Raise the loader following the *Loader Raising Procedure* (page 48).
2. Rotate each tire by hand. The proper amount of chain deflection should be 1/8 in. to 1 in. (3 to 25 mm) forward and rearward. If the chain deflection is more than 1 in. (25 mm) or less than 1/8 in. (3 mm) in either direction, the chains should be adjusted.

## Adjusting Chain Tension

1. Raise the loader following the *Loader Raising Procedure* (page 48).
2. Remove the tire from the axle to be adjusted.
3. Loosen (but **DO NOT** remove) the bolts holding the axle to the chaincase.
4. **Front Chain Tension** – To tighten the front chain, move the front axle assembly toward the front of the loader. To loosen the chain, move the front axle assembly toward the rear of the loader.

**Rear Chain Tension** – To tighten the rear chain, move the rear axle assembly rearward. To loosen the chain, move the rear axle assembly toward the front of the loader.

5. After proper tension is achieved, retighten the bolts.

**Important:** *Be careful not to over-tighten the drive chains. Over-tightening will cause premature drive chain and axle sprocket wear.*

6. Reinstall the tire.
7. Repeat Steps 2 through 6 for any other axle requiring adjustment.
8. Lower the loader following the *Loader Lowering Procedure* (page 49).

## Engine Air Cleaner

---

**Important:** *Failure to follow proper filter servicing instructions could result in catastrophic engine damage.*

The air cleaner assembly consists of an outer (primary) filter element and an inner (secondary) filter element. An air filter restriction indicator for monitoring the condition of the elements is located on the front of the air cleaner. If the air filter becomes restricted, this indicator turns red to warn the operator that the air cleaner requires service. Push the reset button located at the end of the indicator after fitting a clean element. For replacement elements, refer to the *Replacement Parts* chart (page 48).

**Note:** *Before replacing the filter element(s), push the reset button on the indicator. Start the engine and adjust the throttle to full speed. If the indicator does not turn red, do not replace the element(s).*

The outer element should be replaced only when the restriction indicator turns red. The inner element should be replaced every third time the outer element is replaced, unless the outer element is damaged or the inner element is visibly dirty.

Along with a daily check of the restriction indicator, check that the air cleaner intake hose and clamps, and the mounting bracket hardware are properly secure.

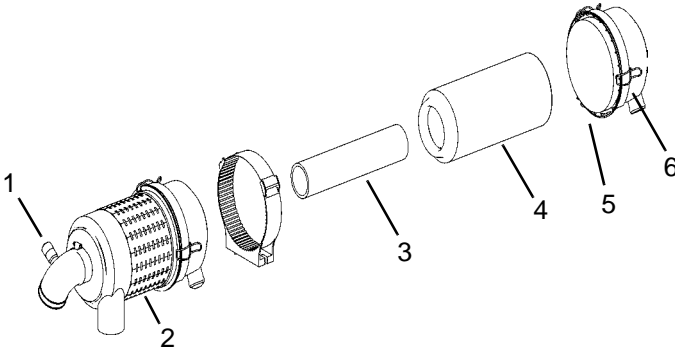

**Figure 36 Dual-Element Air Cleaner**

- |                          |                         |
|--------------------------|-------------------------|
| 1. Restriction Indicator | 3. Inner Filter Element |
| 2. Element Housing       | 4. Outer Filter Element |
|                          | 5. Element Cover        |
|                          | 6. Dust Ejector         |

## Access

1. Open the engine cover and then the rear door (page 49).
2. Unlatch the three latches on the air cleaner and remove the cover. Clean out any dirt built up in the cover assembly.

## Outer Element

1. Carefully pull the outer element out of the housing. Never remove the inner element unless it is to be replaced.
2. Clean out any dirt built up in the housing. Leave the inner element installed during this step to prevent debris from entering the engine intake manifold.
3. Use a trouble light inside the outer element to inspect for bad spots, pinholes or ruptures. Replace the outer element if any damage is noted. The outer element must be replaced if it is oil- or soot-laden.

**Note:** *Cleaning the outer element is not recommend.*

## Inner Element

*Note: Replace the inner element only if it is visibly dirty or if the outer element has been replaced three times.*

Before removing the inner element from the housing, clean out any dirt built up in the housing. Leave the inner element installed during this step to prevent debris from entering the engine intake manifold. Remove the inner element.

## Reinstallation

1. Check the inside of the housing for any damage that may interfere with the elements.
2. Be sure that the element sealing surfaces are clean.
3. Insert the element(s), making sure that they are seated properly.
4. Secure the cover to the housing with the three clamps.
5. Check the hose connections and make sure they are all clamped and tightened properly.
6. Reset the indicator by pressing the reset button.

*Note: Periodically inspect intake system tubes, rubber elbows and connections. Inspect for cracks, loose fits and loose clamps. Tighten or replace as needed. Intake system must be air tight.*

## Engine Service

---

Refer to the *Maintenance Interval* chart (page 75) for change intervals. Refer to the *Replacement Parts* chart (page 48) for filter part numbers.

### Checking Engine Mounting Hardware

All bolts that secure the engine mounting brackets to the engine and the loader frame should be checked and re-torqued as necessary. Refer to the *Torque Specifications* chart (page 93) for torque information.



### **WARNING**

**Allow hot engine and hydraulic system components to cool before servicing.**

### Checking Engine Oil Level

Open engine cover (page 49), pull out the dipstick and check the oil level. Markings on the dipstick represent FULL and LOW (add oil) levels.

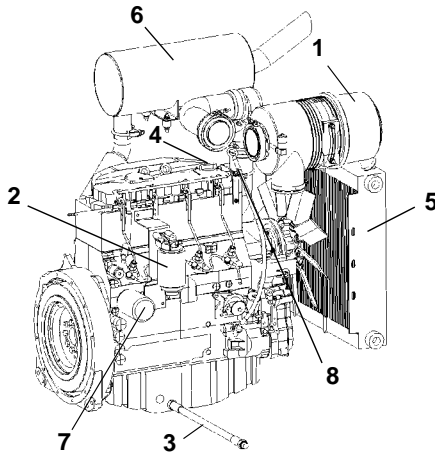

**Figure 37 Engine Service Components**

- |   |  |
|---|--|
| <ul style="list-style-type: none"> <li>1. Air Cleaner</li> <li>2. Fuel Filter</li> <li>3. Engine Oil Drain Valve</li> </ul> | <ul style="list-style-type: none"> <li>4. Engine Oil Fill Cap</li> <li>5. Radiator/Cooler</li> <li>6. Muffler</li> <li>7. Engine Oil Filter</li> <li>8. Engine Oil Dipstick</li> </ul> |
|---|--|

## Changing Engine Oil and Filter

**Note:** For new units, the initial oil change should be after the first 50 hours.

**Important:** Always dispose of waste lubricating oil according to local regulations or take to a recycling center for disposal; do not pour onto the ground or down the drain.

The loader has an engine oil filter located on the left side of the engine, in front of the battery. Follow the ROPS/FOPS procedure (page 50) to lift up the ROPS/FOPS and access the filter.

**Note:** Before removing the oil filter, remove the rear skid plate cover to drain the engine filter oil.



**Figure 38 Remote Engine Oil Drain**

Access for draining the engine oil is located behind the left rear tire.

To add new oil, open the engine access cover. Remove the oil fill cap and add the recommended type and quantity of oil. Refer to the *Lubrication* chart, page 52. Visually inspect the remote oil drain hose for damage or leaks.

## Changing Fuel Filter

The loader has a fuel filter located on the left side of the engine, in front of the battery. Follow the ROPS/FOPS and Lock Mechanism procedure (page 50) to lift up the ROPS and access the filter. Clamp off the fuel line to stop fuel flow BEFORE replacing the filter. Remove the spin-on filter cartridge. Install the new cartridge and check for leaks.

## Hydraulic System

Refer to the *Maintenance Interval* chart (page 75) for service intervals. Refer to the *Replacement Parts* chart (page 48) for filter part numbers.

**⚠ WARNING** Before servicing the hydraulic system, be sure the lift arm is lowered.

### Checking Hydraulic Oil Level

The loader has a sight gauge located at the right rear of the skid-steer loader inside the engine compartment (Figure 39). Check the fluid level with the lift arm lowered and the attachment on the ground.

Add hydraulic oil as required. Refer to the *Lubrication* chart (page 52). Replace the fill cap.



**Figure 39** Sight Gauge and Fill Tube

### Changing Hydraulic Oil Filter

To check the hydraulic filter element, run the engine at full throttle and normal operating temperature. Lift the engine access cover. Observe the hydraulic filter indicator located on the filter head (Figure 40). If the indicator is green, the filter does not need replacing. If the indicator is red, replace the filter following the instructions below.

1. Turn off the engine.
2. Open the reservoir drain plug located on the inside bottom of the right riser.
3. Drain the oil out to a level below the point where the filter attaches to the reservoir.
4. Replace the reservoir drain plug.



**Figure 40** Hydraulic Oil Filter and Indicator

5. Refill the hydraulic oil reservoir with oil. Refer to the *Lubrication* chart (page 52).
6. Spin off the old hydraulic filter element and spin on the new filter element.

## **Changing Hydraulic Oil**

The hydraulic oil must be replaced if it becomes contaminated, after major repairs and after 1000 hours or one year of use.

1. Install a catch pan of sufficient capacity under the oil reservoir, see page 51.
2. Remove the drain plug located on the bottom front of the oil reservoir, behind the right rear tire. Allow the oil to drain.
3. Reinstall the drain plug.
4. Change the oil filter.
5. Refill the reservoir. Refer to the *Lubrication* topic (page 51).
6. Start the engine and operate the hydraulic controls.
7. Stop the engine and check for leaks at the filter and reservoir drain plug.
8. Check the fluid level and add fluid if needed.

## **Bucket Cutting Edge**

---

The bucket cutting edge should be replaced when it is worn to within 1 in. (25 mm) of the bucket body.

## **Alternator/Fan Belt**

---

Refer to the separate engine manual for setting proper belt tension. If the belt is worn, cracked or otherwise deteriorated, replace the belt following the procedure in the engine manual.

## **Wheel Nuts**

---

Wheel nut torque must be checked before initial operation and every two hours thereafter until the wheel mounting hardware torque remains at 180 ft-lbs (244 N·m). When wheels are removed and reinstalled this procedure must be repeated.

## **Lift Arm Pivots**

---

The All-Tach pivot should be torqued periodically to 240 ft-lbs (325 N·m). Refer to the *Maintenance Interval* chart (page 75).



# Cooling System

---

**Important:** Check the cooling system daily to prevent overheating, loss of performance and engine damage.

## Cleaning the Cooling System

 **WARNING** Allow sufficient time for the oil cooler to cool before working on or near it. Parts get extremely hot during operation and can burn you.

The oil cooler assembly is mounted between the engine and the hinged rear door. When operating correctly, air is blown through the openings between the fins by the engine fan. During operation dust and debris can build up on the engine side of the oil cooler and restrict air flow through the fins. To remove this restriction, use compressed air or a water hose and direct the flow through the fins from the rear of the cooler towards the engine.

## Tires

---

 **WARNING** Inflating or servicing tires can be dangerous. When possible, trained personnel should service and mount tires. To avoid possible death or serious injury, follow the safety precautions below.

To keep tire wear even, rotate the tires from front to rear and rear to front.

It is important to keep the same size tire on each side of the loader to prevent excessive wear on tires, chains, or other damage. If different sizes are used, tires will be turning at different speeds, causing excessive wear.

*Note:* The tread bar of all tires should face the same direction.

- BE SURE the rim is clean and free of rust.
- Lubricate the tire beads and rim flanges with a soap solution. Do NOT use oil or grease.
- Use a clip-on tire chuck with remote hose and gauge, allowing you to stand clear while inflating the tire.
- NEVER inflate beyond 35 psi (240 kPa) to seat the beads. If the beads have not seated by the time the pressure reaches 35 psi (240 kPa), deflate the assembly, reposition the tire on the rim, lubricate both parts and re-inflate. Inflation pressure beyond 35 psi (240 kPa) with unseated beads may break the bead or rim with explosive force sufficient to cause death or serious injury.
- After seating the beads, adjust the inflation pressure to the recommended operating pressure.
- Do NOT weld, braze or otherwise attempt to repair and use a damaged rim.

## Checking Tire Pressure

Correct tire pressure should be maintained for all tires to enhance operating stability and extend tire life. Refer to the charts below for proper inflation pressures.

4640/4840 Tire	Inflation Pressure	
	psi	kPa
10 x 16.5 8-ply Heavy-Duty Floatation	60	415
12 x 16.5 10-ply Heavy-Duty Floatation	65	450
10 x 16.5 10-ply Severe-Duty	65	450
33 x 15.5 x 16.5 Extra Wide Floatation	60	415

5640/6640 Tire	Inflation Pressure	
	psi	kPa
12 x 16.5 10-ply Heavy-Duty Floatation	65	450
14 x 17.5 12-ply Heavy-Duty Floatation	65	450
12 x 16.5 12-ply Severe-Duty	65	450

## Heater Filters

Loaders with the optional heater or heater/air conditioner include two filters: fresh air intake and Recirculation air.

Refer to the *Replacement Parts* topic (page 48) for filter part numbers. Filters should be replaced as needed.

**Fresh Air Intake Filter:** Located on the backside of the main unit. Tilt back the ROPS/FOPS for access and slide out the filter.

**Recirculation Air Filter:** Located on the front of the ROPS/FOPS rear deck panel. Remove four screws and pull out the filter.

**Note:** *Keeping the cab clean will reduce need for service and help ensure proper air conditioner and heater operation. Failure to do so can cause evaporator and heater core plugging, fan noise, vibration and failure.*

# Electrical System

---

## Circuit Breakers

The circuit breakers for the inside electrical system are located on the right instrument panel.

## Battery

 **WARNING** Before servicing the battery or electrical system, be sure the battery disconnect switch is in the OFF position.

The battery on the loader is a 12-volt, wet cell battery. To access the battery, open the engine access cover, unlatch and open the rear grille.

The battery top must be kept clean. Clean it with an alkaline solution (ammonia or baking soda and water). After foaming has stopped, flush the battery top with clean water. If the terminals and cable connection clamps are corroded or have a build-up, disconnect the cables and clean the terminals and clamps with the same alkaline solution.

 **WARNING** Explosive gas is produced when a battery is in use or being charged. Keep flames or sparks away from the battery area. ALWAYS charge the battery in a well-ventilated area.

Never lay a metal object on top of a battery, because a short circuit can result.

Battery acid is harmful on contact with skin or fabrics. If acid spills, follow these first-aid tips:

1. Immediately remove any clothing on which acid spills.
2. If acid contacts the skin, rinse the affected area with running water for 10 to 15 minutes.
3. If acid contacts the eyes, flood the eyes with running water for 10 to 15 minutes. See a doctor at once. Never use any medication or eye drops unless prescribed by the doctor.
4. To neutralize acid spilled on the floor, use one of the following mixtures:
  - a. 1 pound (0.5 kg) of baking soda in 1 gallon (4 L) of water, or
  - b. 1 pint (0.5 L) of household ammonia in 1 gallon (4 L) of water

Whenever the battery is removed, be sure to disconnect the negative (-) battery terminal connection first.



# CHAPTER 6

## TROUBLESHOOTING

### Electrical System

Problem	Possible Cause	Remedy
<b>Entire electrical system does not function.</b>	Battery disconnect switch is OFF position. Circuit breakers on engine panel have tripped or malfunctioned. Main wiring harness connectors at rear of ROPS not properly plugged in. Battery terminals or cables loose or corroded. Battery is faulty.	Turn battery disconnect switch to ON. Check circuit and locate problem causing breaker to trip (breaker resets automatically). Check main harness connectors. Clean battery terminals and cables and retighten them. Test battery, replace as needed.
<b>No instrument panel lamps with keyswitch turned to "ON".</b>	Circuit breaker #1 has tripped. Battery terminals or cables are loose or corroded.	Check circuit, install new fuse. Clean battery terminals and cables and retighten them.
<b>Fuel gauge does not work.</b>	Faulty fuel gauge sender. Faulty fuel gauge. Loose wiring/terminal connections.	Replace fuel gauge sender. Replace fuel gauge. Verify wiring connections.
<b>Engine temperature gauge does not work.</b>	Faulty temperature sender. Faulty temperature gauge. Loose wiring/terminal connections.	Replace temperature sender. Replace temperature gauge. Verify wiring connections.
<b>Hourmeter does not work.</b>	Loose wiring/terminal connections. Faulty alternator. Faulty hourmeter.	Verify wiring connections. Repair alternator. Replace hourmeter.

# Electrical System

Problem	Possible Cause	Remedy
<p><b>Starter will not engage when key is turned to START.</b></p>	<p>Seat or restraint bar switch malfunctioning or not actuated.</p> <p>Poor connections to starter relay in instrument panel.</p> <p>Battery terminal or cables loose or corroded.</p> <p>Faulty starter relay in instrument panel.</p> <p>Battery discharged or defective.</p> <p>Starter solenoid not functioning.</p> <p>Ignition wiring, seat switch, restraint bar switch, etc. loose or disconnected.</p> <p>Starter relay malfunctioning.</p> <p>Starter or pinion faulty.</p>	<p>Contact your dealer.</p> <p>Verify relay connections.</p> <p>Clean terminal, cables and retighten.</p> <p>Contact your dealer.</p> <p>Recharge or replace battery.</p> <p>Contact your dealer.</p> <p>Check wiring for poor connections, broken leads; repair wiring or connection.</p> <p>Verify relay is working properly, replace.</p> <p>Remove starter; repair/replace as needed.</p>
<p><b>Work lights not functioning properly.</b></p>	<p>Single light not working; light bulb burned out, faulty wiring.</p> <p>No lights; 30 ampere light fuse blown.</p> <p>Faulty light switch or poor ground.</p>	<p>Check and replace light bulb as needed. Check wiring connection to light.</p> <p>Check circuit and locate trouble before replacing fuse.</p> <p>Check ground wire connections. Replace light switch.</p>
<p><b>Lift/Tilt and/or drive lock solenoids do not work.</b></p>	<p>Wiring to solenoids disconnected or faulty.</p> <p>Restraint bar or seat switch malfunction.</p> <p>Faulty solenoid valve coil.</p> <p>Solenoid relay malfunctioning.</p> <p>Faulty hydraulic solenoid relay in instrument panel.</p>	<p>Troubleshoot circuit, repair.</p> <p>Contact your dealer.</p> <p>Contact your dealer.</p> <p>Verify relay is working properly, replace.</p> <p>Contact your dealer.</p>

# Engine

Problem	Possible Cause	Remedy
<p><b>Engine turns over but will not start.</b></p>	<p>Engine cranking speed too slow.</p> <p>Auxiliary valve engaged.</p> <p>Fuel tank empty.</p> <p>Glow plug module malfunctioning.</p> <p>Fuel shut-off solenoid not energizing.</p> <p>Engine not warm enough.</p> <p>Ambient temperature too low.</p> <p>Fuel filter plugged.</p> <p>Fuel pump not working.</p>	<p>Battery requires recharging or replacing, or, in cold temperatures, pre-warm the engine.</p> <p>Return control valves to neutral.</p> <p>Refill fuel tank.</p> <p>Check connection and voltage, replace as needed.</p> <p>Check electrical connections and voltage to shut-off solenoid.</p> <p>Install block heater.</p> <p>Install block heater.</p> <p>Replace filter.</p> <p>Contact your dealer.</p>
<p><b>Engine overheats.</b></p>	<p>Crankcase oil level too low or too high.</p> <p>Fan air circulation blocked or restricted.</p> <p>Fan shroud improperly positioned.</p> <p>Grade of oil improper or excessively dirty.</p> <p>Exhaust restricted.</p> <p>Air filter restricted.</p> <p>Low coolant level.</p> <p>Fan belt loose.</p>	<p>Add or remove oil as required.</p> <p>With engine off, remove blockage or restriction.</p> <p>Contact your dealer.</p> <p>Drain and replace with proper grade new oil.</p> <p>Allow exhaust to cool, remove restriction.</p> <p>Replace filter(s).</p> <p>Add coolant.</p> <p>Tighten fan belt.</p>

## Hydrostatic Drive System

Problem	Possible Cause	Remedy
<b>No response from either hydrostatic drive or the lift/tilt systems.</b>	<p>Hydraulic oil viscosity too heavy.</p> <p>Hydraulic oil too low.</p> <p>Drive coupling failure.</p>	<p>Allow longer warm-up or replace oil with proper viscosity oil.</p> <p>Check for low oil level in reservoir, add oil.</p> <p>Replace coupling.</p>
<b>Traction drive will not operate in either direction.</b>	<p>Parking brake is engaged.</p> <p>Hydraulic oil level low.</p> <p>Control rod linkage disconnected.</p> <p>Low or no charge pressure.</p> <p>Hydrostatic pump(s) relief valves malfunctioning.</p>	<p>Disengage parking brake.</p> <p>Check for low oil level in reservoir, add oil.</p> <p>Check linkage connection at control levers and neutral centering mechanisms, reconnect linkage.</p> <p>Contact your dealer.</p> <p>Contact your dealer.</p>
<b>Sluggish acceleration.</b>	<p>Air in hydraulic system.</p> <p>Hydraulic oil level too low.</p> <p>Hydrostatic system charge pressure low.</p> <p>Drive motor(s) or hydrostatic pump(s) have internal damage or leakage.</p>	<p>Cycle lift and tilt cylinders to maximum stroke and maintain pressure for short time to clear air from system. Also check for low oil level in reservoir, fill as needed.</p> <p>Check for low oil level in reservoir, add oil.</p> <p>Contact your dealer.</p> <p>Contact your dealer.</p>



## Hydrostatic Drive System

Problem	Possible Cause	Remedy
<p><b>Hydrostatic drive overheating.</b></p>	<p>Drive system overloaded continuously.</p> <p>Lift/tilt or auxiliary system overloaded continuously.</p> <p>Drive motor(s) or hydrostatic pump(s) have internal damage or leakage.</p> <p>Oil cooler fins plugged with debris.</p> <p>Hydraulic oil filter plugged or restricted.</p> <p>Loader being operated in high temperatures with no air circulation.</p>	<p>Improve efficiency of operation.</p> <p>Improve efficiency of operation.</p> <p>Contact your dealer.</p> <p>Clean oil cooler fins.</p> <p>Replace filter.</p> <p>Reduce duty cycle; improve air circulation.</p>

# Hydraulic System

Problem	Possible Cause	Remedy
<p><b>Hydrostatic (drive) system is noisy.</b></p>	<p>Hydraulic oil viscosity too heavy.</p> <p>Air in hydraulic system.</p> <p>Drive motor(s) or hydrostatic pump(s) have internal damage or leakage.</p>	<p>Allow longer warm-up or replace oil with proper viscosity oil.</p> <p>Cycle lift and tilt cylinders to maximum stroke and maintain pressure for short time to clear air from system. Also check for low oil level in reservoir, fill as needed.</p> <p>Contact your dealer.</p>
<p><b>Left side doesn't drive in either direction. Right side operates normally.</b></p>	<p>Rear hydrostatic pump arm control lever loose.</p> <p>Relief valves on rear hydrostatic pump malfunctioning.</p> <p>Control rod linkage to rear hydrostatic pump disconnected.</p>	<p>Tighten.</p> <p>Contact your dealer.</p> <p>Attach control rod linkage.</p>
<p><b>Left side doesn't drive in one direction.</b></p>	<p>Relief valve on rear hydrostatic pump malfunctioning.</p> <p>Rear hydrostatic pump malfunctioning.</p>	<p>Contact your dealer.</p> <p>Contact your dealer.</p>
<p><b>Right side doesn't drive in either direction. Left side operates normally.</b></p>	<p>Front hydrostatic pump arm control level loose.</p> <p>Relief valves on front hydrostatic pump malfunctioning.</p> <p>Control rod linkage to front hydrostatic pump disconnected.</p>	<p>Tighten.</p> <p>Contact your dealer.</p> <p>Attach control rod linkage.</p>
<p><b>Right side doesn't drive in one direction.</b></p>	<p>Relief valve on front hydrostatic pump malfunctioning.</p> <p>Front hydrostatic pump malfunctioning.</p>	<p>Contact your dealer.</p> <p>Contact your dealer.</p>

## Hydraulic System

Problem	Possible Cause	Remedy
<b>Lift/Tilt controls fail to respond.</b>	<p>Restraint bar raised.</p> <p>Hydraulic oil viscosity too heavy.</p> <p>Hydraulic oil level low.</p> <p>Solenoid valve(s) malfunctioning.</p> <p>Restraint bar or seat switch malfunctioning.</p>	<p>Lower restraint bar.</p> <p>Allow longer warm-up or replace with proper viscosity oil.</p> <p>Check oil level in reservoir. If oil is low, check for external leak, repair and add oil.</p> <p>Check electrical connections to lift solenoid and repair.</p> <p>Contact your dealer.</p>
<b>Hydraulic cylinder action is slow for lift and/or tilt functions.</b>	<p>Low engine speed.</p> <p>Hydraulic oil viscosity too heavy.</p> <p>Hydraulic oil level low.</p> <p>Control linkage restricted.</p> <p>Hydraulic oil leaking past cylinder piston seals.</p> <p>Worn pump.</p> <p>Solenoid valve(s) malfunctioning or one of the two cartridges on solenoid valve is malfunctioning.</p>	<p>Operate engine at higher speed.</p> <p>Allow longer warm-up or replace with proper viscosity oil.</p> <p>Check oil level in reservoir. If oil is low, check for an external leak. Repair and add oil.</p> <p>Check control linkage, readjust for full spool travel.</p> <p>Contact your dealer.</p> <p>Contact your dealer.</p> <p>Check electrical connections to lift solenoid and repair connections as needed. If solenoid valve is still not functioning properly, contact your dealer.</p>
<b>Bucket does not level on the lift cycle.</b>	<p>Self-leveling valve misadjusted or malfunctioning.</p>	<p>Contact your dealer.</p>
<b>Jerky lift arm and bucket action.</b>	<p>Seat or restraint bar switch malfunctioning.</p> <p>Air in hydraulic system.</p> <p>Oil in hydraulic reservoir low.</p>	<p>Contact your dealer.</p> <p>Cycle/lift and tilt cylinders to maximum stroke and maintain pressure for short time to clear air from system.</p> <p>Check and add oil.</p>

## Hydraulic System

Problem	Possible Cause	Remedy
<b>No down pressure on the bucket.</b>	Control valve in "float" position. Tilt cylinders malfunctioning.	Take control out of "float" position. Contact your dealer.
<b>Bucket drifts down with tilt control in neutral.</b>	Oil leaking past tilt cylinder seals (internal or external). Self-leveling valve is malfunctioning. Leaking hydraulic hoses, tubes or fittings between control valve and cylinders.	Contact your dealer.  Contact your dealer.  Check oil level in reservoir. If oil is low, check for external leaks, repair and add oil.
<b>Bucket will not tilt, lift arm works properly.</b>	Tilt solenoid valve malfunctioning.  Tilt spool in control valve not actuated or leaking.	Check electrical connections to tilt solenoid and repair connections as needed. If still not functioning properly, contact your dealer.  Check valve control linkage and/or tube connections to valve.
<b>Lift arm does not raise, bucket tilt works properly.</b>	Lift solenoid valve could be malfunctioning.  Lift spool in control valve not actuated or leaking.	Check electrical connections to lift solenoid and repair connections as needed. If still not functioning properly, contact your dealer.  Check valve control linkage and/or tube connections to valve.
<b>Lift arm does not maintain raise position with left control in NEUTRAL.</b>	Oil leading past lift cylinder seals (internal or external). Oil leaking past lift spool in control valve. Self-leveling valve malfunctioning. Leaking hydraulic hoses, tubes or fittings between control valve and cylinders.	Contact your dealer.  Contact your dealer.  Contact your dealer.  Inspect hoses and tubes, tighten fittings as needed. Replace as needed.

## Hydraulic System

Problem	Possible Cause	Remedy
<p><b>Lift arm will not lower or raise.</b></p>	<p>Lift arm support device engaged.</p> <p>Restraint bar not lowered.</p> <p>Lift solenoid valve malfunctioning.</p> <p>Seat or restraint bar switch malfunction.</p>	<p>Raise lift arm and remove support device.</p> <p>Check electrical connections to solenoid. Repair or replace as needed.</p> <p>Lower restraint bar.</p> <p>Contact your dealer.</p>
<p><b>Auxiliary hydraulics do not function.</b></p>	<p>Restraint bar raised.</p> <p>Spool lock solenoid malfunctioning.</p> <p>Restraint bar or seat switch malfunctioning.</p> <p>Load sensing signal line loose or broken.</p> <p>Load sensing compensator not functioning.</p> <p>High pressure compensator on pump not functioning.</p>	<p>Lower the restraint bar.</p> <p>Check electrical connections to lift solenoid and repair connections as needed. If still not functioning properly, contact your dealer.</p> <p>Contact your dealer.</p> <p>Check line, tighten or replace if necessary.</p> <p>Contact your dealer.</p> <p>Contact your dealer.</p>
<p><b>High-flow auxiliary functions slowly.</b></p>	<p>Control linkage misadjusted.</p> <p>Low engine speed.</p> <p>Hydraulic oil level low.</p> <p>Hydraulic oil viscosity too heavy.</p>	<p>Check linkage, readjust for full spool travel.</p> <p>Operate engine at higher speed.</p> <p>Add oil.</p> <p>Allow longer warm-up, or replace oil with proper viscosity oil.</p>

## Hydraulic System

Problem	Possible Cause	Remedy
<b>High-flow auxiliary does not function.</b>	Restraint bar raised. Spool lock solenoid malfunctioning.  Restraint bar or switch malfunctioning.  Load sensing signal line loose or broken.  Load sensing compensator not functioning.  High pressure compensator on pump not functioning.	Lower the restraint bar.  Check electrical connections to solenoid, repair connections as needed. If still not functioning properly, contact your dealer.  Contact your dealer.  Check line, tighten or replace if necessary.  Contact your dealer.  Contact your dealer.

# CHAPTER 7

## MAINTENANCE

This Maintenance Interval Chart was developed to match the *Service* chapter of this manual. Detailed information on each service procedure may be found in the *Service* chapter. A Maintenance Log follows the chart for recording the maintenance performed. Recording the 10-hour (or daily) service intervals would be impractical and is therefore not recommended.

**Important:** *Under severe operating conditions, more frequent service than the recommended intervals may be required. You must decide, based on your use, if your operation requires more frequent service.*

Service Procedure	Maximum Interval		
	10 Hours (or Daily)	250 Hours	500 Hours (or Annually)
Foreign Material Removal (page 51)	l		
Check Engine Air Cleaner Restriction Indicator (page 55)	l		
Check Engine Oil Level (page 57)	l		
Check Hydraulic Oil Level (page 59)	l		
Check Tire Pressures (page 62)	l		
Grease Lift Arm, Hitch, Cylinder Pivots and Latch Pins (page 51)	l		
Check Bucket Cutting Edge (page 60)	l		
Test Safety Interlock System (page 18)	l		
Check Coolant Level (page 61)	l		
Clean Cooling System (page 61)	l		
Check Drive Chain Tension (page 55)		l	
Check Wheel Nuts Torque (page 60)	m	l	
Check All-Tach Pivot Torque (page 60)		l	
Check Oil Level in Chaincases (page 54)		l	
Check Alternator/Fan Belt Tensions (page 60)		l	
Change Engine Oil and Filter (page 58)	o	v	l
Change Hydraulic Oil Filter (page 59)	o		l
Check Battery (page 63)			l
Check Engine Mounting Hardware (page 57)			l
Change Fuel Filters (page 59)			l
Change Hydraulic Oil (page 60)			u
Change Chaincase Oil (page 54)	o		u

m Perform the initial procedure at 2 hours then at "l" intervals.

o Perform the initial procedure at 50 hours then at "●" or "u" intervals.

v Severe operating conditions.

u Perform the procedure at 1000 hours.





# Maintenance Log

Date	Hours	Service Procedure

# Maintenance Log

<b>Date</b>	<b>Hours</b>	<b>Service Procedure</b>

# CHAPTER 8

## SPECIFICATIONS

### Loader Specifications

Specification	4640	4640 Turbo
Operating Weight	6200 lbs (2812 kg)	6250 lbs (2835 kg)
Shipping Weight	5715 lbs (2592 kg)	5545 lbs (2515 kg)
Rated Operating Load <sup>1</sup> (capacity)	1500 lbs (680 kg)	1500 lbs (680 kg)
Engine		
Make	Deutz	Deutz
Model	F3M2011	BF3M2011
Displacement	142 in <sup>3</sup> (2.3 L)	142 in <sup>3</sup> (2.3 L)
Power (net)	46 hp (34.3 kW) @ 2600 rpm	60 hp (44.7 kW) @ 2500 rpm
Peak Torque	106 ft-lb (144 N·m) @ 1700 rpm	140 ft-lb (190 N·m) @ 1600 rpm
Hydraulic System (theoretical)		
Main Hydraulic System Pressure	2750 psi (190 bar)	2750 psi (190 bar)
Standard-Flow Rating	19 gpm (72 L/min)	19 gpm (72 L/min)
High-Flow Rating		30 gpm (114 L/min)
Electrical		
Battery	12-Volt DC, 950 CCA	12-Volt DC, 950 CCA
Starter	12-Volt DC (2.3 kW)	12-Volt DC (2.3 kW)
Alternator	95 amperes	95 amperes
Capacities		
Chaincase (each)	8 U.S. qts (7.5 L)	8 U.S. qts (7.5 L)
Engine Oil	8.3 U.S. qts (7.9 L)	8.3 U.S. qts (7.9 L)
Fuel Tank	15 U.S. gal (57 L)	17 U.S. gal (64 L)
Hydraulic Reservoir	12 U.S. gal (45 L)	12 U.S. gal (45 L)
Sound (with Deluxe Sound Kit)		
Pressure Level (Operator Ear)	83 dB(A)	83 dB(A)
Power Level (Environmental)	101 dB(A)	101 dB(A)

1. Operating load (capacity) rated with an 65 in. (1651 mm) (10.8 ft<sup>3</sup> [0.3 m<sup>3</sup>]) dirt/construction bucket in accordance with SAE J818.

**Specification****4840**

---

Operating Weight	6480 lbs (2939 kg)
Shipping Weight	5825 lbs (2642 kg)
Rated Operating Load <sup>1</sup> (capacity)	1700 lbs (771 kg)
Engine	
Make	Deutz
Model	F4M2011
Displacement	190 in <sup>3</sup> (3.1 L)
Power (net)	61.2 hp (45 kW) @ 2500 rpm
Peak Torque	144 ft-lb (195 N·m) @ 1700 rpm
Hydraulic System (theoretical)	
Main Hydraulic System Pressure	2750 psi (190 bar)
Standard-Flow Rating	19 gpm (72 L/min)
High-Flow Rating	30 gpm (114 L/min)
Electrical	
Battery	12-Volt DC, 950 CCA
Starter	12-Volt DC (2.3 kW)
Alternator	95 amperes
Capacities	
Chaincase (each)	8.0 U.S. qts (7.5 L)
Engine Oil	11.5 U.S. qts (10.8 L)
Fuel Tank	17 U.S. gal (64 L)
Hydraulic Reservoir	12 U.S. gal (45 L)
Sound (with Deluxe Sound Kit)	
Pressure Level (Operator Ear)	83 dB(A)
Power Level (Environmental)	101 dB(A)

1. Operating load (capacity) rated with an 65 in. (1651 mm) (10.8 ft<sup>3</sup> [0.3 m<sup>3</sup>]) dirt/ construction bucket in accordance with SAE J818.

<b>Specification</b>	<b>5640</b>	<b>5640 Turbo</b>
Operating Weight	7380 lbs (3348 kg)	7430 lbs (3370 kg)
Shipping Weight	6740 lbs (3057 kg)	6790 lbs (3080 kg)
Rated Operating Load <sup>1</sup> (capacity)	2000 lbs (907 kg)	2000 lbs (907 kg)
<b>Engine</b>		
Make	Deutz	Deutz
Model	F4M2011	BF4M2011
Displacement	190 in <sup>3</sup> (3.1 L)	190 in <sup>3</sup> (3.1 L)
Power (net)	60 hp (45 kW) @ 2500 rpm	82 hp (61 kW) @ 2500 rpm
Peak Torque	144 ft-lb (195 N-m) @ 1700 rpm	199 ft-lb (270 N-m) @ 1600 rpm
<b>Hydraulic System (theoretical)</b>		
Main Hydraulic System Pressure	3000 psi (207 bar)	3000 psi (207 bar)
Standard-Flow Rating	23 gpm (87 L/min)	23 gpm (87 L/min)
<b>Electrical</b>		
Battery	12-Volt DC, 950 CCA	12-Volt DC, 950 CCA
Starter	12-Volt DC (2.3 kW)	12-Volt DC (2.3 kW)
Alternator	95 amperes	95 amperes
<b>Capacities</b>		
Chaincase (each)	8.0 U.S. qts (7.5 L)	8.0 U.S. qts (7.5 L)
Engine Oil	11.5 U.S. qts (10.8 L)	11.5 U.S. qts (10.8 L)
Fuel Tank	19.0 U.S. gal (72 L)	19.0 U.S. gal (64 L)
Hydraulic Reservoir	16 U.S. gal (61 L)	16 U.S. gal (61 L)
<b>Sound (with Deluxe Sound Kit)</b>		
Pressure Level (Operator Ear)	83 dB(A)	83 dB(A)
Power Level (Environmental)	101 dB(A)	102 dB(A)
1. Operating load (capacity) rated with an 68 in. (1727 mm) (15.3 ft <sup>3</sup> [0.43 m <sup>3</sup> ]) dirt/ construction bucket in accordance with SAE J818.		

**Specification****6640**

---

Operating Weight	7800 lbs (3538 kg)
Shipping Weight	7160 lbs (3247 kg)
Rated Operating Load <sup>1</sup> (capacity)	2400 lbs (1089 kg)
Engine	
Make	Deutz
Model	BF4M2011
Displacement	190 in <sup>3</sup> (3.1 L)
Power (net)	82 hp (61 kW) @ 2500 rpm
Peak Torque	199 ft-lb (270 N·m) @ 1600 rpm
Hydraulic System (theoretical)	
Main Hydraulic System Pressure	3000 psi (207 bar)
Standard-Flow Rating	23 gpm (87 L/min)
High-Flow Rating	30 gpm (114 L/min)
Electrical	
Battery	12-Volt DC, 950 CCA
Starter	12-Volt DC (2.3 kW)
Alternator	95 amperes
Capacities	
Chaincase (each)	8.0 U.S. qts (7.6 L)
Engine Oil	11.5 U.S. qts (10.8 L)
Fuel Tank	24 U.S. gal (91 L)
Hydraulic Reservoir	16 U.S. gal (61 L)
Sound (with Deluxe Sound Kit)	
Pressure Level (Operator Ear)	83 dB(A)
Power Level (Environmental)	102 dB(A)

1. Operating load (capacity) rated with an 68 in. (1727 mm) (15.3 ft<sup>3</sup> [0.43 m<sup>3</sup>]) dirt/construction bucket in accordance with SAE J818.

## Standard Features

---

- Fuel Level Gauge
- Engine Coolant Temperature Gauge and Indicator Light
- Hourmeter
- Oil Pressure Indicator Light
- Battery Charge Indicator Light
- Seatbelt Indicator Light and Buzzer
- Choice of four control types: T-Bar, Hand/Foot, Dual Hand or T-Bar Joystick
- Foot Throttle (T-Bar and Dual Hand only)
- Acoustical Material and Head liner
- Adjustable Operator Restraint Bar with Armrests
- ROPS/FOPS ISO Level II
- Skid Plate for Clean Out
- Interior Dome Light
- Hydraloc™ System – Brakes and Interlock for Starter, Lift Cylinders, Tilt Cylinders, Wheel Drives,
- Dual-Element Air Cleaner with Visual Indicator
- Anti-Vandalism Rear Door
- Pre-Heat Starting Assist
- Servo-Controlled Hydrostatic Drive
- Lift Arm Support Device
- Self-Leveling Lift Action
- Dual Front and Rear Halogen Work Lights and Dual Tail Lights
- Bi-directional Auxiliary Hydraulics with Flat-Faced Couplers
- Powerview® Lift Arm
- All-Tach™ Attachment Mounting System: Two Lever (Manual)
- Engine Auto-Shutdown System

## Optional Features

---

- Upper-torso Restraint (required with 2-speed transmission)
- 3-inch Wide Seatbelt –
- Where Required by Law
- Sliding Side Windows
- Rear-View Mirror
- Adjustable Suspension Seat
- Impact-Resistant Front Door
- Front Door with Wiper
- Operator's Compartment Heater/Defroster/Air Conditioner
- Audible Back-Up Alarm
- Strobe Light
- Bucket Bolt-On Cutting Edge Kits
- Four-Point Lift Kit
- Single-Point Lift Kit
- Hydraulic Couplers Kit
- Centrifugal Pre-Cleaner
- Engine Pan Heater
- 2-Speed Transmission
- Bi-directional High-Flow Auxiliary Hydraulics with Flat-Faced Couplers
- Hydraglide™ Ride Control System
- All-Tach™ Attachment Mounting System: Power-A-Tach
- Adjustable Suspension Seat
- Hydraulic Oil Filter Indicator Light
- Horn
- Spark Arresting Muffler

# Dimensional Specifications

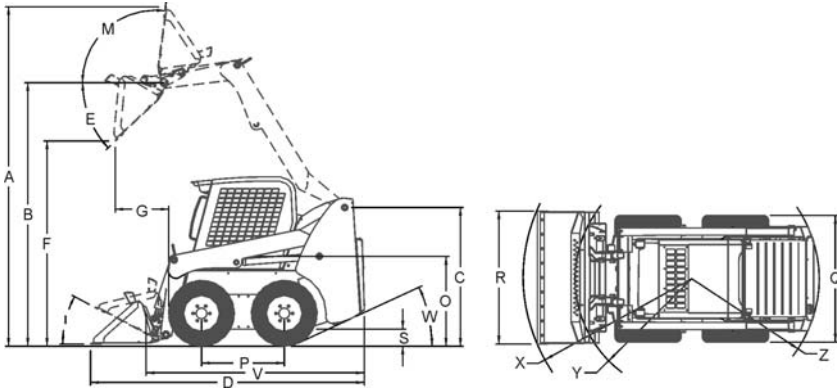

<b>SL4640</b>		<b>10.8 ft<sup>3</sup> (0.3 m<sup>3</sup>) Bucket w/10 x 16.5 Tires</b>	
		<b>inches</b>	<b>mm</b>
<b>A</b>	Overall Operation Height – Fully Raised	149.0	3785
<b>B</b>	Height to Hinge Pin – Fully Raised	115.5	2934
<b>C</b>	Overall Height – Top of ROPS	78.0	1981
<b>D</b>	Overall Length – Bucket Down	122.8	3118
<b>E</b>	Dump Angle at Full Height	40°	
<b>F</b>	Dump Height	89.5	2273
<b>G</b>	Dump Reach – Full Height	25.0	635
<b>J</b>	Rollback at Ground	27°	
<b>M</b>	Rollback Angle at Full Height	86°	
<b>O</b>	Seat to Ground Height	37.5	953
<b>P</b>	Wheel Base – Nominal	37.5	953
<b>Q</b>	Overall Width – Less Bucket	63.5	1613
<b>R</b>	Bucket Width – Overall	66.0	1679
<b>S</b>	Ground Clearance – to Chassis (Between Wheels)	7.5	191
<b>U</b>	Maximum Grading Angle	91°	
<b>V</b>	Overall Length (Less Bucket)	89.8	2291
<b>W</b>	Departure Angle	25°	
<b>X</b>	Clearance Circle – Front (With Bucket)	74.5	1892
<b>Y</b>	Clearance Circle – Front (Less Bucket)	47.0	1194
<b>Z</b>	Clearance Circle – Rear	59.5	1511



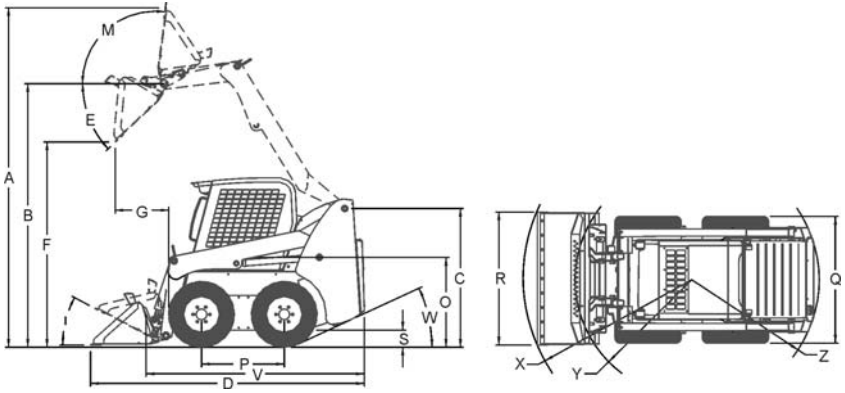

<b>SL4840</b>		<b>10.8 ft<sup>3</sup> (0.3 m<sup>3</sup>) Bucket w/10 x 16.5 Tires</b>	
		<b>inches</b>	<b>mm</b>
<b>A</b>	Overall Operation Height – Fully Raised	149.0	3785
<b>B</b>	Height to Hinge Pin – Raised	115.5	2934
<b>C</b>	Overall Height – of ROPS	78.0	1981
<b>D</b>	Overall Length – Down	126.3	3207
<b>E</b>	Dump Angle at Full Height	40°	
<b>F</b>	Dump Height	89.5	2273
<b>G</b>	Dump Reach – Full Height	25.0	635
<b>J</b>	Rollback at Ground	27°	
<b>M</b>	Rollback Angle at Full Height	86°	
<b>O</b>	Seat to Ground Height	37.5	953
<b>P</b>	Wheel Base – Nominal	41.5	1054
<b>Q</b>	Overall Width – Less Bucket	63.5	1613
<b>R</b>	Bucket Width – Overall	66.0	1679
<b>S</b>	Ground Clearance – to Chassis (Between Wheels)	7.5	191
<b>U</b>	Maximum Grading Angle	91°	
<b>V</b>	Overall Length (Less Bucket)	93.3	2370
<b>W</b>	Departure Angle	25°	
<b>X</b>	Clearance Circle – (With Bucket)	76.0	1930
<b>Y</b>	Clearance Circle – Front (Less Bucket)	48.0	1219
<b>Z</b>	Clearance Circle – Rear	61.5	1562

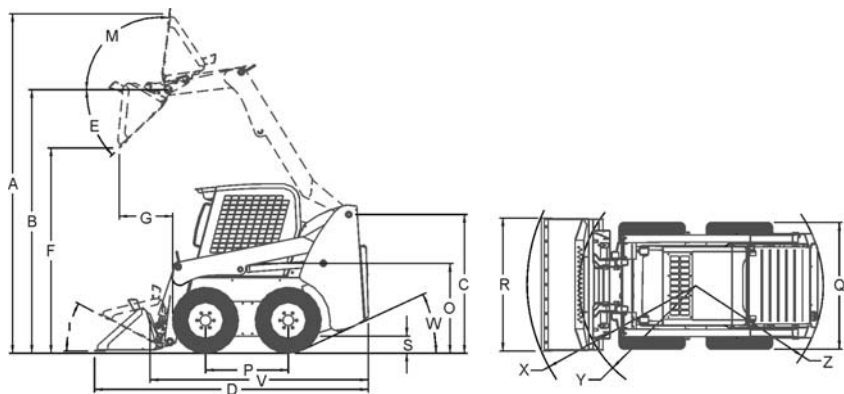

<b>SL5640</b>		<b>15.3 ft<sup>3</sup> (0.43 m<sup>3</sup>) Bucket w/12 x 16.5 Tires</b>	
		<b>inches</b>	<b>mm</b>
<b>A</b>	Overall Operation Height – Fully Raised	162.0	4115
<b>B</b>	Height to Hinge Pin – Fully Raised	123.0	3124
<b>C</b>	Overall Height – Top of ROPS	81.0	2057
<b>D</b>	Overall Length – Bucket Down	131.0	3327
<b>E</b>	Dump Angle at Full Height	40°	
<b>F</b>	Dump Height	93.5	2375
<b>G</b>	Dump Reach – Bucket Full Height	32.8	833
<b>J</b>	Rollback at Ground	30°	
<b>M</b>	Rollback Angle at Full Height	84°	
<b>O</b>	Seat to Ground Height	42.0	1067
<b>P</b>	Wheel Base – Nominal	42.5	1080
<b>Q</b>	Overall Width – Less Bucket	67.0	1702
<b>R</b>	Bucket Width – Overall	70.0	1778
<b>S</b>	Ground Clearance – to Chassis (Between Wheels)	8.0	203
<b>U</b>	Maximum Grading Angle	82°	
<b>V</b>	Overall Length (Less Bucket)	95.5	2426
<b>W</b>	Departure Angle	26°	
<b>X</b>	Clearance Circle – Front (With Bucket)	82.0	2083
<b>Y</b>	Clearance Circle – Front (Less Bucket)	50.5	1283
<b>Z</b>	Clearance Circle – Rear	66.0	1676

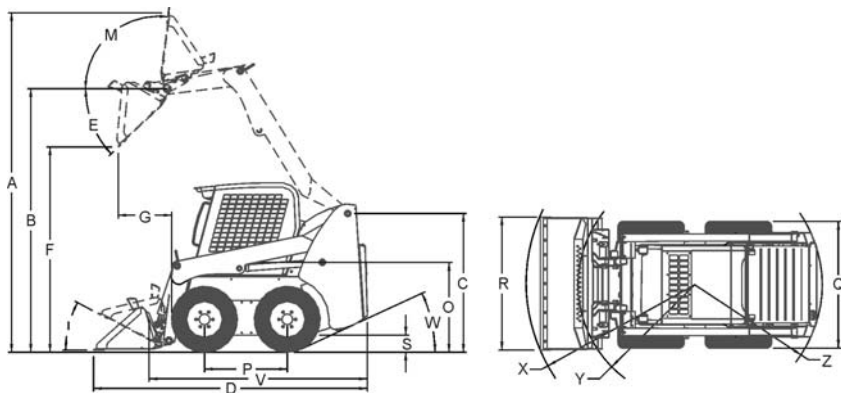

<b>SL6640</b>		<b>15.3 ft<sup>3</sup> (0.43 m<sup>3</sup>) Bucket w/12 x 16.5 Tires</b>	
		<b>inches</b>	<b>mm</b>
<b>A</b>	Overall Operation Height – Fully Raised	167.0	4242
<b>B</b>	Height to Hinge Pin – Fully Raised	123.0	3124
<b>C</b>	Overall Height – of ROPS	81.0	2057
<b>D</b>	Overall Length – Bucket Down	141.5	3594
<b>E</b>	Dump Angle at Full Height	40°	
<b>F</b>	Dump Height	91.25	2318
<b>G</b>	Dump Reach – Bucket Full Height	35.5	902
<b>J</b>	Rollback at Ground	30°	
<b>M</b>	Rollback Angle at Full Height	84°	
<b>O</b>	Seat to Ground Height	42.0	1067
<b>P</b>	Wheel Base – Nominal	48.4	1219
<b>Q</b>	Overall Width – Less Bucket	67.0	1702
<b>R</b>	Bucket Width – Overall	74.0	1880
<b>S</b>	Ground Clearance – to Chassis (Between Wheels)	8.0	203
<b>U</b>	Maximum Grading Angle	82°	
<b>V</b>	Overall Length (Less Bucket)	101.0	2794
<b>W</b>	Departure Angle	25°	
<b>X</b>	Clearance Circle – Front (With Bucket)	89.5	2273
<b>Y</b>	Clearance Circle – Front (Less Bucket)	53.0	1346
<b>Z</b>	Clearance Circle – Rear	68.0	1727

# Capacities and Ratings

## SL 4640/4840 Models

*Note: Use the Common Materials and Densities table (page 90) for selecting the appropriate bucket.*

### Dirt/Construction Buckets

Description	Weight	SL4640 Rating	SL4840 Rating
68 in/15.3 ft <sup>3</sup> (1727 mm/0.43 m <sup>3</sup> )	465 lbs (211 kg)	1393 lbs (632 kg)	1567 lbs (710 kg)
68 in/19 ft <sup>3</sup> (1727 mm/0.54 m <sup>3</sup> )	500 lbs (227 kg)	1279 lbs (581 kg)	1471 lbs (643 kg)
65 in/10.8 ft <sup>3</sup> (2286 mm/0.31 m <sup>3</sup> )	310 lbs (141 kg)	1492 lbs (677 kg)	1640 lbs (744 kg)
65 in/14.7 ft <sup>3</sup> (2286 mm/0.42 m <sup>3</sup> )	380 lbs (172 kg)	1413 lbs (641 kg)	1563 lbs (709 kg)

### Dirt/Construction with Spill Guard Bucket

67 in/14.5 ft <sup>3</sup> (1702 mm/0.41 m <sup>3</sup> )	383 lbs (174 kg)	1544 lbs (700 kg)	1685 lbs (764 kg)
---	---------------------	----------------------	----------------------

### Utility/Snow Bucket

72 in/32.5 ft <sup>3</sup> (1829 mm/0.92 m <sup>3</sup> )	645 lbs (293 kg)	1083 lbs (491 kg)	1245 lbs (565 kg)
65 in/18.6 ft <sup>3</sup> (1657 mm/0.53 m <sup>3</sup> )	395 lb (179 kg)	1280 lbs (581 kg)	1418 lbs (643 kg)

### Utility Bucket

69.5 in/15.5 ft <sup>3</sup> (1765 mm/0.44 m <sup>3</sup> )	489 lbs (222 kg)	1123 lbs (509 kg)	1332 lbs (604 kg)
---	---------------------	----------------------	----------------------

### Low Profile/Grading Bucket

67 in/14.5 ft <sup>3</sup> (1702 mm/0.41 m <sup>3</sup> )	383 lbs (174 kg)	1228 lbs (557 kg)	1469 lbs (666 kg)
---	---------------------	----------------------	----------------------

### Pallet Forks

15.75 in (400 mm) Forks with Backrest Rating per EN474-3	645 lbs (293 kg)	1013 lbs (459 kg)	1205 lbs (567 kg)
19.68 in (500 mm) Forks with Backrest Rating per EN474-3	395 lb (179 kg)	940 lb (426 kg)	1130 lb (513 kg)
24 in (670 mm) Forks with Backrest per SAE 1197	492 lbs (223 kg)	865 lbs (392 kg)	1055 lbs (479 kg)

## SL 5640/6640 Models

*Note: Use the Common Materials and Densities table (page 90) for selecting the appropriate bucket.*

<b>Dirt/Construction Buckets</b>			
<b>Description</b>	<b>Weight</b>	<b>SL5640 Rating</b>	<b>SL6640 Rating</b>
68 in/15.3 ft <sup>3</sup> (1727 mm 0.43 m <sup>3</sup> )	465 lbs (211 kg)	1594 lbs (723 kg)	2135 lbs (968 kg)
68 in/19 ft <sup>3</sup> (1727 mm 0.54 m <sup>3</sup> )	500 lbs (227 kg)	1570 lbs (712 kg)	2043 lbs (927 kg)
72 in/20.4 ft <sup>3</sup> (1829 mm 0.58 m <sup>3</sup> )	525 lbs (238 kg)	1635 lbs (742 kg)	2140 lbs (971 kg)
<b>Dirt/Construction with Spill Guard Bucket</b>			
75 in/17.5 ft <sup>3</sup> (1905 mm 0.5 m <sup>3</sup> )	500 lbs (227 kg)	2055 lbs (932 kg)	2450 lbs (1111 kg)
<b>Utility/Snow Bucket</b>			
72 in/32.5 ft <sup>3</sup> (1829 mm 0.92 m <sup>3</sup> )	645 lbs (293 kg)	1430 lbs (649 kg)	1638 lbs (743 kg)
<b>Utility Bucket</b>			
72 in/27 ft <sup>3</sup> (1829 mm 0.76 m <sup>3</sup> )	595 lbs (270 kg)	1533 lbs (695 kg)	1953 lbs (886 kg)
<b>Snow Bucket</b>			
90 in/41.1 ft <sup>3</sup> (2286 mm 1.16 m <sup>3</sup> )	750 lbs (340 kg)	1468 lbs (666 kg)	1713 lbs (777 kg)
<b>Low Profile/Grading Bucket</b>			
74.5 in/16.8 ft <sup>3</sup> (1892 mm 0.48 m <sup>3</sup> )	512 lbs (232 kg)	1541 lbs (699 kg)	2000 lbs (907 kg)
<b>Pallet Forks</b>			
15.75 in (400 mm) Forks with Backrest Rating per EN474-3	492 lbs (223 kg)	1348 lbs (611 kg)	1538 lbs (698 kg)
19.68 in (500 mm) Forks with Backrest Rating per EN474-3	492 lbs (223kg)	1273 lbs (577 kg)	1463 lbs (664 kg)
24 in (670 mm) Forks with Backrest per SAE 1197	492 lbs (223 kg)	1198 lbs (543 kg)	1388 lbs (630 kg)

## Common Materials and Densities

Material	Density	
	lbs/ft <sup>3</sup>	kg/m <sup>3</sup>
Ashes	35-50	560-800
Brick-common	112	1792
Cement	110	1760
Charcoal	23	368
Clay, wet-dry	80-100	1280-1600
Coal	53-63	848-1008
Concrete	115	1840
Cinders	50	800
Coal-anthracite	94	1504
Coke	30	480
Earth-dry loam	70-90	1121-1442
Earth-wet loam	80-100	1281-1602
Granite	93-111	1488-1776
Gravel-dry	100	1602
Gravel-wet	120	1922
Gypsum-crushed	115	1840
Iron ore	145	2320
Lime	60	960
Lime stone	90	1440
Manure-liquid	65	1040
Manure-solid	45	720
Peat-solid	47	752
Phosphate-granular	90	1440
Potash	68	1088
Quartz-granular	110	1760
Salt-dry	100	1602
Salt-rock-solid	135	2160
Sand-dry	108	1728
Sand-wet	125	2000
Sand-foundry	95	1520
Shale-crushed	90	1440
Slag-crushed	70	1120
Snow	15-50	240-800
Taconite	107	1712

*Note: The densities listed are average values and intended only as a guide for bucket selection. For a material that is not in the table, obtain its density value before selecting the appropriate bucket.*

## Bucket Selection

---

To use the table, find the material to be loaded and read its maximum density. Then multiply the volumetric rating of the attachment by the material density to determine if the attachment can safely be used. See page for a listing of attachments and their load ratings.

*Note: Where the material density is listed as a range (clay at 80-100 lbs/ft<sup>3</sup>, for example), always use the maximum density (100 lbs/ft<sup>3</sup> in this example) for making calculations. Also, see the following examples.*

**Example 1:** If clay (density of 80-100 lbs/ft<sup>3</sup>) is to be hauled using a SL4840 model loader using a 10.8 ft<sup>3</sup> Dirt/Construction bucket, the bucket capacity is 10.8 ft<sup>3</sup> and the loader rating is 1700 lbs. Multiply the density of clay (100 lbs/ft<sup>3</sup>) by the capacity of the bucket (10.8 ft<sup>3</sup>) to achieve the weight to be carried (100 lbs/ft<sup>3</sup> x 10.8 ft<sup>3</sup> = 1080 lbs). This number is less than the machine rating, allowing safe use of this bucket in this application.

**Example 2:** If granite (density of 1488-1776 kg/m<sup>3</sup>) is to be hauled using a SL5640 model loader using a 0.43 m<sup>3</sup> Dirt/Construction bucket, the bucket capacity is 0.43 m<sup>3</sup> and the loader rating is 907 kg. Multiply the density of granite (1776 kg/m<sup>3</sup>) by the capacity of the bucket (0.43 m<sup>3</sup>) to achieve the weight to be carried (1776 kg/m<sup>3</sup> x 0.43 m<sup>3</sup> = 763.7 kg). This number is less than the machine rating, allowing safe use of this bucket in this application.





# CHAPTER 9

## TORQUE SPECIFICATIONS

Use these torque values when tightening hardware (excluding locknuts, and self-tapping, thread-forming, and sheet metal screws) unless otherwise specified.

UNIFIED NATIONAL THREAD	GRADE 2		GRADE 5		GRADE 8	
	DRY	LUBED	DRY	LUBED	DRY	LUBED
8-32	19*	14*	30*	22*	41*	31*
8-36	20*	15*	31*	23*	43*	32*
10-24	27*	21*	43*	32*	60*	45*
10-32	31*	23*	49*	36*	68*	51*
1/4-20	66*	50*	9	75*	12	9
1/4-28	76*	56*	10	86*	14	10
5/16-18	11	9	17	13	25	18
5/16-24	12	9	19	14	25	20
3/8-16	20	15	30	23	45	35
3/8-24	23	17	35	25	50	35
7/16-14	32	24	50	35	70	55
7/16-20	36	27	55	40	80	60
½-13	50	35	75	55	110	80
½-20	55	40	90	65	120	90
9/16-12	70	55	110	80	150	110
9/16-18	80	60	120	90	170	130
5/8-11	100	75	150	110	220	170
5/8-18	110	85	180	130	240	180
3/4-10	175	130	260	200	380	280
3/4-16	200	150	300	220	420	320
7/8-9	170	125	430	320	600	460
7/8-14	180	140	470	360	660	500
1-8	250	190	640	480	900	680
1-12	270	210	710	530	1000	740
<b>METRIC COARSE THREAD</b>						
METRIC COARSE THREAD	GRADE 8.8		GRADE 10.9		GRADE 12.9	
	DRY	LUBED	DRY	LUBED	DRY	LUBED
M6-1	8	6	11	8	13.5	10
M8-1.25	19	14	27	20	32.5	24
M10-1.5	37.5	28	53	39	64	47
M12-1.75	65	48	91.5	67.5	111.5	82
M14-2	103.5	76.5	145.5	108	176.5	131
M16-2	158.5	117.5	223.5	165.5	271	200

\*All torque values are in ft-lbs except those marked with an \* which are in lbs.  
For metric torque value (N-m) multiply ft-lbs value by 1.355 or the in-lbs value by 0.113.

## **GEHL CONSTRUCTION WARRANTY**

GEHL CONSTRUCTION DIVISION of the GEHL COMPANY, hereinafter referred to as Gehl, warrants new Gehl construction equipment to the Original Retail Purchaser to be free from defects in material and workmanship for a period of twelve (12) months from the Warranty Start Date, except as set forth below.

### **GEHL CONSTRUCTION WARRANTY SERVICE INCLUDES:**

Genuine Gehl parts and labor costs required to repair or replace equipment at the selling dealer's business location.

---

**GEHL MAKES NO REPRESENTATIONS OR WARRANTIES OF ANY KIND, EXPRESS OR IMPLIED (INCLUDING THE IMPLIED WARRANTIES OF MERCHANTABILITY AND FITNESS FOR PARTICULAR PURPOSE), EXCEPT AS EXPRESSLY STATED IN THIS WARRANTY STATEMENT.**

---

### **GEHL WARRANTY SERVICE DOES NOT INCLUDE:**

1. Transportation to selling dealer's business location or, at the option of the Original Retail Purchaser, the cost of a service call.
2. Used equipment.
3. Components covered by their own non-Gehl warranties, such as tires, trade accessories and engines.
4. Normal maintenance service and expendable, wear-out items.
5. Repairs or adjustments caused by: improper use; failure to follow recommended maintenance procedures; use of unauthorized parts or attachments; accident or other casualty.
6. Liability for incidental or consequential damages of any type, including, but not limited to lost profits and expenses of acquiring replacement equipment.

No agent, employee or representative of Gehl has any authority to bind Gehl to any warranty except as specifically set forth herein. Any of these limitations excluded by local law shall be deemed deleted from this warranty; all other terms will continue to apply.

# INDEX

<b>A</b>	
Accessory Plug .....	21
Adjustments .....	50
Control Handles .....	50
Engine Speed Control .....	51
Fuel Sender .....	50
Air Conditioner	
Operation .....	22
Alternator/Fan Belt .....	60
Attachments .....	24, 40
Auto-Shutdown .....	24
Auxiliary Hydraulic Controls	
High-Flow .....	36
Standard Flow .....	35
<b>B</b>	
Battery .....	63
Jump-starting .....	39
Bucket Cutting Edge .....	60
Bucket, Usage .....	42
Digging with a Bucket .....	42
Driving on an Incline .....	42
Driving over Rough Terrain .....	42
Dumping Into a Box .....	43
Dumping Onto a Pile .....	43
Dumping Over an Embankment .....	43
Leveling the Ground .....	44
Loading a Bucket .....	43
Scraping with a Bucket .....	44
<b>C</b>	
Chaincases .....	54
Checking and Adding Oil ..	54
Draining Oil .....	54
Circuit Breakers .....	63
Cold Starting Procedure .....	38
Common Materials and Densities .....	90
Control/Indicator Switch .....	4
<b>CONTROLS and SAFETY EQUIPMENT</b>	
Cooling System .....	61
Cleaning .....	61
<b>D</b>	
Dealer Services .....	47
Dome Light .....	21
Drive Chains	
Adjusting Chain Tension ..	55
Checking Chain Tension ..	55
Dual Hand Controls .....	34
Auxiliary Hydraulic Controls .....	35
Drive Control .....	34
Lift/Tilt Control .....	34
<b>E</b>	
Emergency Exit .....	20
Engine Air Cleaner .....	55
Engine Compartment Access .....	49
Engine Mounting Hardware ...	57
Engine Service	
Changing Fuel Filter .....	59
Changing Oil and Filter ...	58
Checking Oil Level .....	57
Engine Speed Control .....	22
<b>F</b>	
Foreign Material Removal ....	51
<b>G</b>	
Guards and Shields .....	17
<b>H</b>	
Hand/Foot Controls .....	32
Auxiliary Hydraulic Controls .....	35
Drive Controls .....	32
Lift/Tilt Controls .....	33
Heater	
Filter Service .....	62

Operation .....	22
Heater and Air Conditioner	
Operation .....	22
Highway Travel .....	44
Horn .....	19
Hydraulic System .....	59
Changing Oil .....	60
Changing Oil Filters .....	59
Checking Oil Level .....	59

**I**

Instrument Panel .....	26
Introduction .....	1

**L**

Lift Arm Pivots .....	60
Lift Arm Support Device .....	20
Loader	
Lifting .....	46
Lowering Procedure .....	49
Raising Procedure .....	48
Storing .....	45
Transporting .....	45
Loader Identification .....	3
Lubrication .....	51

**M**

Maintenance Schedule	
Maintenance Interval	
Chart .....	75
Maintenance Log .....	76
Mandatory Safety Shutdown	
Procedure .....	6

**O**

OPERATION .....	37
Operator Restraint Bar .....	17
Operator's Seat .....	18

**P**

Parking Brake .....	19
Parking the Loader .....	39
Potential Hazards .....	8

**R**

Replacement Parts .....	48
-------------------------	----

Ride Control System .....	24
ROPS/FOPS .....	19
Tilting Back .....	50

**S**

Safety Decals .....	8
New Decal Application .....	8
No-Text Decals .....	13
Text Decals .....	9
Safety Interlock System	
Testing .....	18
Safety Reminders .....	6
Seatbelt	
Upper-Torso Restraint .....	18
Self-Leveling .....	42
SERVICE .....	47
Specifications .....	79
Dimensional	
Specifications .....	84
Loader Specifications .....	79
Optional Features .....	83
Standard Features .....	83
Speed Control .....	22
Starting the Engine .....	37
Before Starting	
the Engine .....	37
Stopping the Loader .....	38

**T**

T-Bar Controls .....	29
Auxiliary Hydraulic	
Controls .....	35
Drive Controls .....	29
Lift/Tilt Controls .....	29
T-Bar/Joystick Controls .....	30
Drive Controls .....	30
Lift/Tilt Controls .....	31
Tires .....	61
Checking Tire Pressure .....	62
Torque Specifications .....	93
Troubleshooting .....	65
Electrical .....	65
Engine .....	67
Hydraulic System .....	70

Hydrostatic Drive System ..	68	Wheel Nuts .....	60
Two-Speed Transmission ....	24	Work Lights .....	21
<b>W</b>			
WARRANTY .....	94		



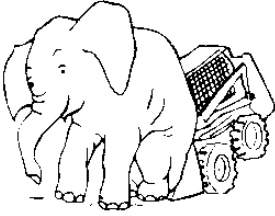

WRONG

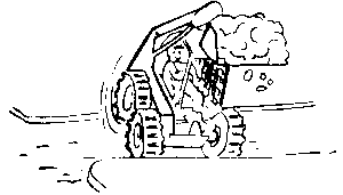

 Never exceed rated operating load.

WRONG



 Always carry attachment as low as possible. Do not travel or turn with the lift arm raised. Load, unload and turn on flat level surface.

WRONG

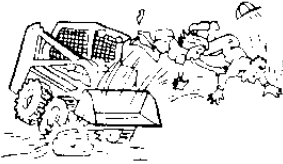



 Never carry riders.

 Keep bystanders away from work area.

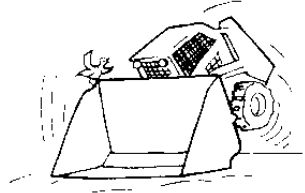
WRONG



 Never modify equipment.

 Use only attachments approved for model loader.

WRONG

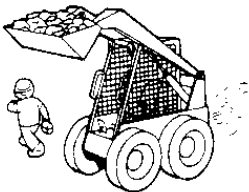

 Never leave loader with engine running or with lift arm up. To park, engage parking brake and put attachment flat on the ground.



**THIS OPERATOR'S MANUAL IS  
PROVIDED FOR OPERATOR USE**

**DO NOT REMOVE FROM THIS MACHINE**

**Do not start, operate or work on this machine until you carefully read and thoroughly understand the contents of this Operator's Manual.**

**Failure to follow safety, operating and maintenance instructions can result in serious injury to the operator or bystanders, poor operation, and costly breakdowns.**

**If you have any questions on proper operation, adjustment or maintenance of this machine, contact your dealer or the Gehl Company Service Department before starting or continuing operation.**

**California Proposition 65 Warnings**

Diesel engine exhaust and some of its constituents are known to the State of California to cause cancer and birth defects or other reproductive harm.

Battery posts, terminals and related accessories contain lead and lead compounds, chemicals known to the State of California to cause cancer and birth defects or other reproductive harm. Wash hands after handling battery.

**GEHL®**

**Gehl Company** 143 Water Street, P.O. Box 179, West Bend, WI 53095-0179 U.S.A.  
[www.gehl.com](http://www.gehl.com)

**© 2005 GEHL COMPANY**  
All Rights Reserved.

917001/CP0905

PRINTED IN U.S.A.